

Parts Book for No. 8644  
9-inch Toolroom Bench Lathe

and No. 644  
9-inch Model A Bench Lathe  
12-Speed Horizontal Motor Drive

—FROM—

**THE SOUTH BEND LATHE WORKS**  
**SOUTH BEND 22, INDIANA, U. S. A.**

FORM 414-1

# How to Order Replacement Parts for South Bend Lathes

This parts list has been prepared especially for the lathe bearing the serial number which appears on the front cover. It should be considered as a part of the lathe equipment and be kept permanently where it will be readily accessible so the correct part numbers can be given when replacement parts are ordered.

The best way to order replacement parts is to send the old part to the factory with the order. This will avoid delay or possible error.

If it is inconvenient to return the old part, be sure to give the following information:

- (1) Serial number of lathe.
- (2) Correct number and name of part.
- (3) Quantity.
- (4) Specify length of wire, cable, conduit, wicking, or hose as the part number does not indicate length.
- (5) Specify dimensions of gasket material as the part number indicates type of material and thickness only.

If the part needed can not be located in this parts list, send a sketch of the part showing all principal dimensions.

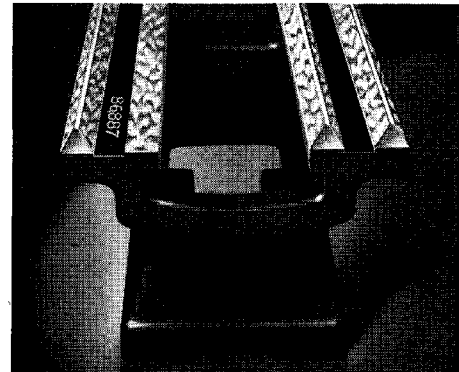

## Specify Serial Number of Lathe When Ordering Parts

The serial number of each lathe is stamped on top of the lathe bed between the V-way and flat way at the tailstock end. This number is an index to the size, type, and model of the lathe. Always specify the serial number on each order for replacement parts or attachments.

## Terms and Prices

All orders for replacement parts will be shipped C.O.D. unless remittance in full is sent with the order.

All prices are F.O.B. South Bend, Indiana, and will be quoted on request.

## Special Instructions

### How to Order Gears

When ordering replacement gears, be sure to give all of the information required as listed and illustrated below.

#### When Ordering Gears Specify—

Serial Number of Lathe	Diameter "D" in Inches
Number and Name of Part	Width "W" in Inches
Quantity	Keyway "K" in Inches
Number of Teeth	Hole "H" in Inches

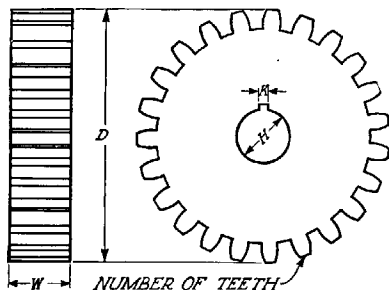

The illustration above shows two views of a gear with parts lettered for use when indicating specifications on your order.

### How to Order Threaded Parts

When ordering threaded parts, other than commercial parts such as standard screws, bolts, and nuts, be sure to give all of the information required as listed below.

#### When Ordering Threaded Parts Specify—

Serial Number of Lathe	Number of Threads per Inch
Number and Name of Part	Kind of Thread:
Quantity	Acme Thread
Outside Diameter of	U. S. Standard Thread
Threads in Inches	Sharp "V" Thread
	Right-or Left-hand Thread

### Repair Parts Supplied for South Bend Lathes Only

The lathe parts listed in this parts list can be supplied only for use on South Bend Lathes. We are not in a position to supply parts for other makes of lathes or for use on jigs, fixtures, special machines or equipment.

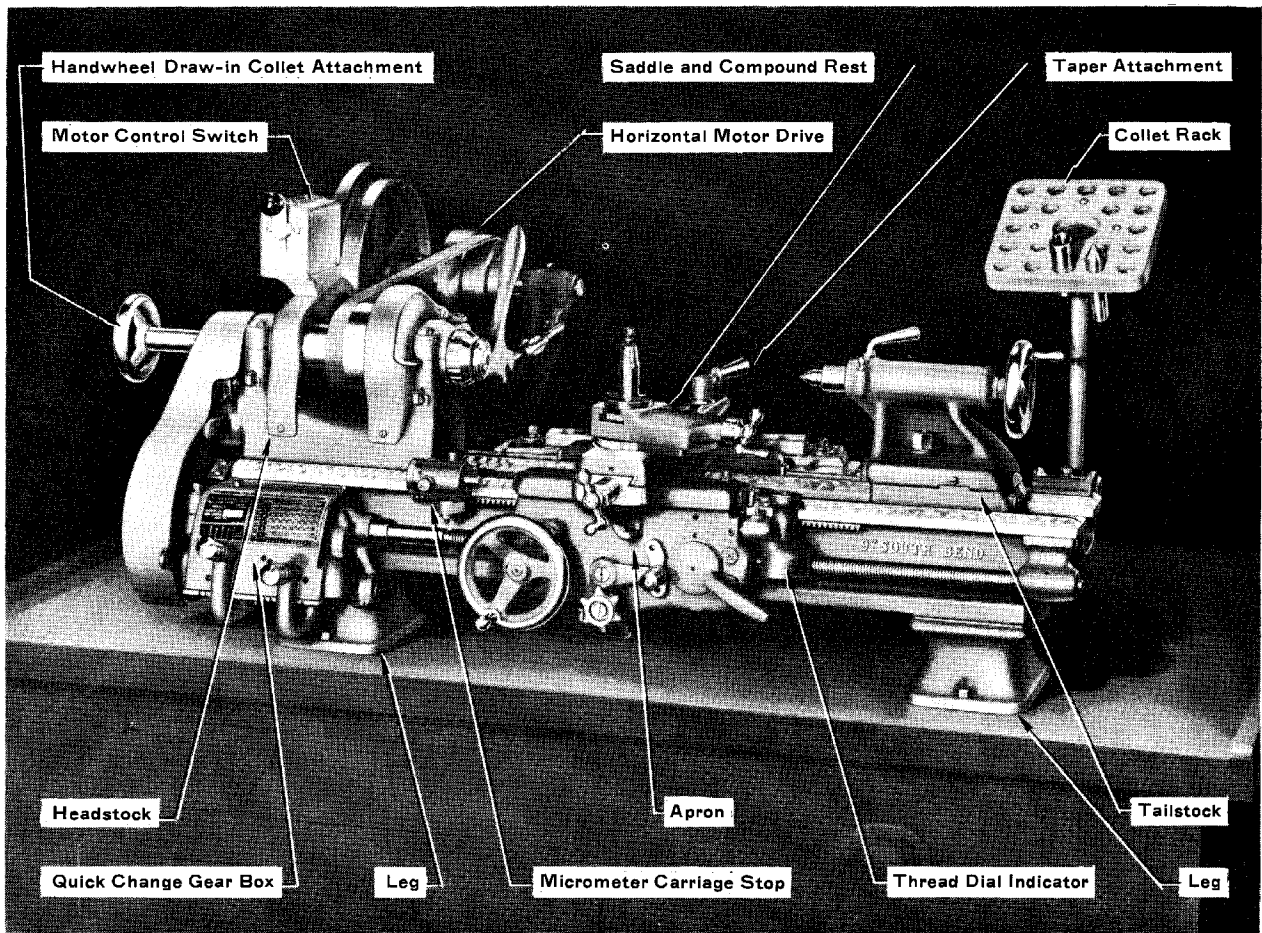

**PARTS LIST No. P-8644**

for

**9-inch Model A**

**12-Speed Horizontal Motor Drive**

**South Bend Toolroom Bench Lathe**

Unit	Page	Unit	Page
Headstock . . . . .	2	Motor Control Switch . . . . .	9
Quick Change Gear Box . . . . .	3	Taper Attachment . . . . .	10
Saddle and Compound Rest . . . . .	4	Handwheel Draw-in Collet Attachment . . . . .	11-A
Apron . . . . .	5	Collet Rack . . . . .	11-A
Horizontal Motor Drive . . . . .	6	Micrometer Carriage Stop . . . . .	12
Tailstock . . . . .	7	Thread Dial Indicator . . . . .	12
Legs . . . . .	8	Thread Cutting Stop . . . . .	12

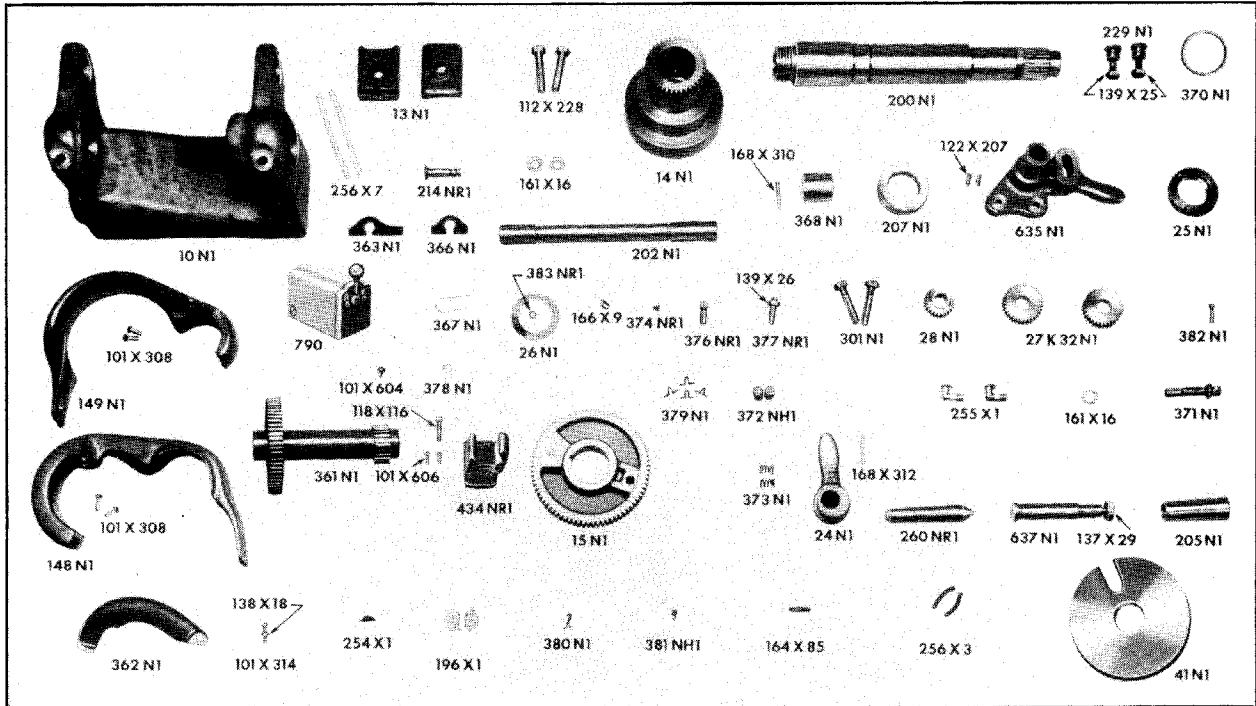

## Headstock Parts

Part No.	Name of Part	Part No.	Name of Part
10N1	Headstock	207N1	Spindle Bearing Ball Thrust Bearing
13N1	Headstock Clamps	214NR1	Bull Gear Plunger
14N1	Spindle Cone	229N1	Twin Gear Studs
15N1	Bull Gear	254X1	Bull Gear Key
24N1	Back Gear Lever	255X1	Headstock Oilers
25N1	Spindle Take-up Nut	256X3	Reverse Bracket Felt Wick, Flat
26N1	Spindle Take-up Nut Washer	256X7	Reverse Twin Gear Stud Felt Wick, Round
27K32N1	Reverse Twin Gears	260NR1	Headstock Center
28N1	Reverse Gear	301N1	Headstock Cap Screws
41N1	Face Plate	361N1	Back Gears
101X308	Bull Gear Guard Screws	362N1	Bull Gear Plunger Guard
101X308	Quill Gear Guard Screws	363N1	Headstock Shim—Large (Brass)
101X314	Bull Gear Plunger Guard Screw	364N1	Headstock Shim—Large (Zinc)
101X604	Back Gear Oil Hole Screw	365N1	Headstock Shim—Small (Brass)
101X606	Motor Control Switch Screws	366N1	Headstock Shim—Small (Zinc)
112X228	Headstock Clamp Screws	367N1	Bull Gear Plunger Spring
118X116	Motor Control Switch Bracket Set Screw	368N1	Eccentric Shaft Bushing
122X207	Reverse Bracket Set Screws	370N1	Spindle Bearing Protecting Ring
137X29	Reverse Shaft Nut	371N1	Reverse Bracket Collar Screw
138X18	Bull Gear Plunger Guard Nut	372NH1	Spindle Bearing Capillary Oiler Felt
139X25	Twin Gear Stud Nuts	373N1	Spindle Bearing Capillary Oiler Spring
139X26	Back Gear Lever Stop Screw Nut	374NR1	Back Gear Spring
148N1	Quill Gear Guard	376NR1	Back Gear Spring Set Screw
149N1	Bull Gear Guard	377NR1	Back Gear Lever Stop Screw
161X16	Headstock Clamp Screw Washers	378N1	Back Gear Oil Hole Washer
161X16	Reverse Bracket Collar Screw Washer	379N1	Spindle Bearing Oil Return Clips (Small)
164X85	Reverse Shaft Key	380N1	Spindle Bearing Oil Return Clips (Large)
166X9	Back Gear Spring Shoe	381NH1	Cone Pulley Oil Hole Plug Screw
168X310	Eccentric Shaft Bushing Pin	382N1	Spindle Take-up Nut Screw
168X312	Back Gear Lever Pin	383NR1	Spindle Take-up Nut Washer Pin
192X21	Drum Switch for 115 Volt A.C.	434NR1	Motor Control Switch Bracket
196X1	Spindle Bearing Capillary Oiler Wool	635N1	Reverse Bracket
200N1	Headstock Spindle	637N1	Reverse Shaft
202N1	Eccentric Shaft	790	Drum Switch for 220-550 Volt A.C. and all D.C.
205N1	Spindle Sleeve		

# Quick Change Gear Box Parts

(See List of Parts on Other Side of This Sheet)

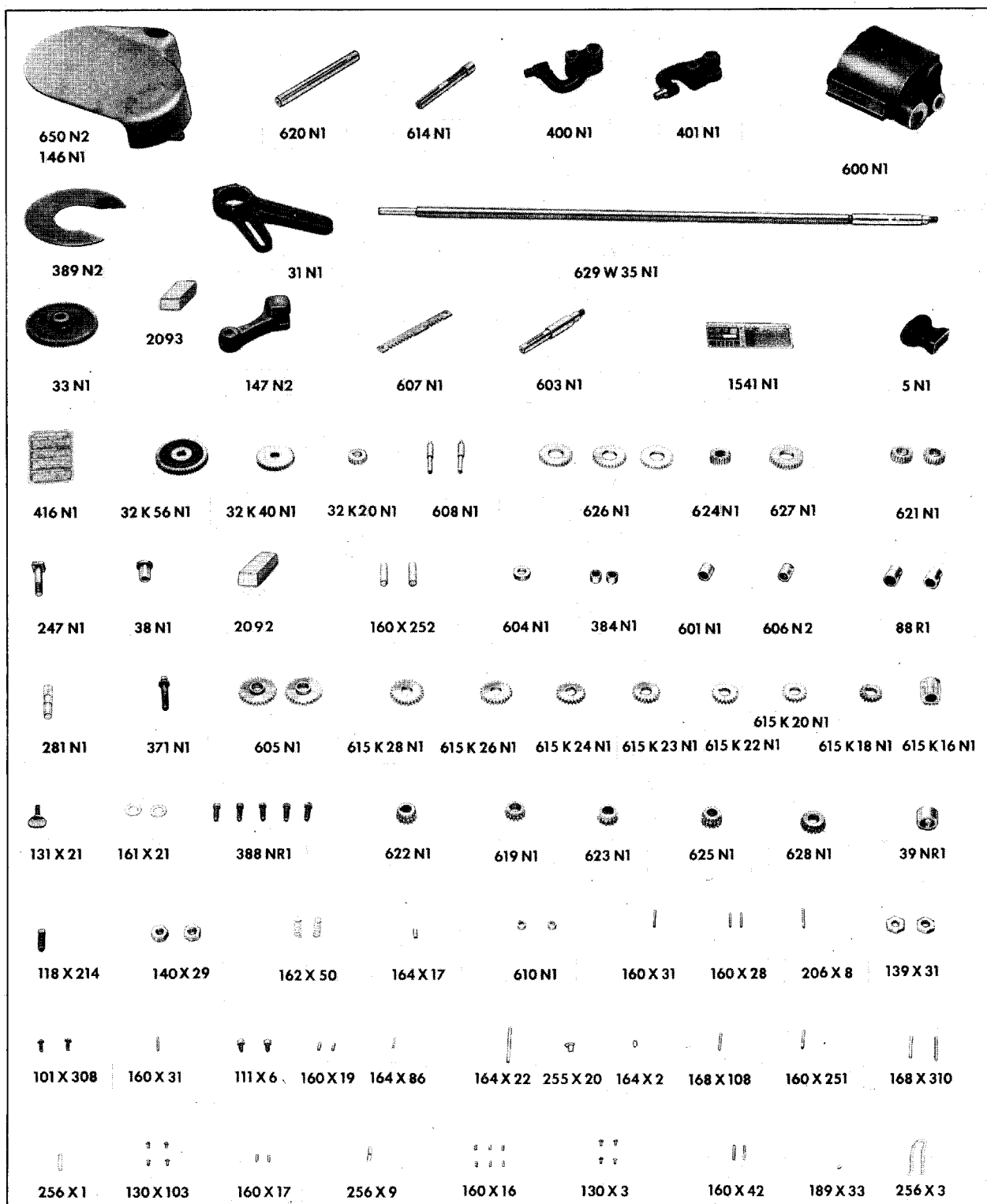

# Quick Change Gear Box Parts

(See Illustration of Parts on Other Side of This Sheet)

Part No.	Name of Part	Part No.	Name of Part
5N1	Rear Lead Screw Bracket.....	256X3	Gear Box Felt Wick, Flat.....
31N1	Change Gear Bracket.....	256X3	Main Drive Shaft Wicking.....
32K20N1	Change Gear—20 Teeth.....	256X9	Wired Cotton Wicking for Gear Box.....
32K40N1	Change Gear—40 Teeth.....	281N1	Stud, Change Gear Guard.....
32K56N1	Change Gear—56 Teeth.....	371N1	Collar Screw, Change Gear Bracket.....
33N1	Idler Gear.....	384N1	Tumbler Idler Gear Bearings.....
38N1	Idler Gear Bushing.....	388NR1	Screws, Gear Box.....
39NR1	Lead Screw Thrust Collar.....	388NR1	Screws, Lead Screw Bracket.....
88R2	Tumbler Plunger Knobs.....	389N2	Change Gear Safety Guard.....
101X308	Screws, Change Gear Safety Guard.....	400N1	Gear Box Tumbler (Right).....
111X6	Screws, Tumbler Guide Bar.....	401N1	Gear Box Tumbler (Left).....
118X214	Set Screw, Gear Guard Bracket.....	416N1	Lubrication Chart.....
130X3	Escutcheon Pins, Lubrication Chart.....	600N1	Gear Box.....
130X103	Escutcheon Pins, Index Plate.....	601N1	Cone Gear Shaft Bushing.....
131X21	Thumb Screw, Gear Guard Bracket.....	603N1	Main Drive Shaft.....
139X31	Nuts, Lead Screw.....	604N1	Main Drive Shaft Collar.....
140X29	Nut, Idler Gear Bolt.....	605N1	Tumbler Idler Gears.....
140X29	Nut, Main Drive Shaft.....	606N2	Main Drive Shaft Bushing.....
146N1	Change Gear Guard for Horizontal Motor Driven Lathes.....	607N1	Tumbler Guide Bar.....
147N2	Change Gear Guard Bracket.....	608N1	Tumbler Plungers.....
160X16	Pins, Small Compound Gear (Cone Gear Shaft)	610N1	Plunger Bushings.....
160X16	Pins, Small Compound Gear (Main Drive Shaft)	614N1	Cone Gear Shaft.....
160X16	Pins, Tumbler Comp. Gear (Cone Gear Shaft)	615K16N1	Cone Gear—16 Teeth.....
160X17	Pin, Large Compound Gear (Main Drive Shaft)	615K18N1	Cone Gear—18 Teeth.....
160X17	Pin, Small Compound Gear (Main Drive Shaft)	615K20N1	Cone Gear—20 Teeth.....
160X19	Pins, Tumbler Guide Bar.....	615K22N1	Cone Gear—22 Teeth.....
160X28	Pins, Tumbler Plunger.....	615K23N1	Cone Gear—23 Teeth.....
160X31	Pin, Main Drive Shaft Bushing.....	615K24N1	Cone Gear—24 Teeth.....
160X42	Pins, Tumbler.....	615K26N1	Cone Gear—26 Teeth.....
160X251	Pin, Cone Gear.....	615K28N1	Cone Gear—28 Teeth.....
160X252	Tumbler Idler Gear Shafts.....	619N1	Small Compound Gear (Main Drive Shaft)....
160X252	Pin, Cone Gear.....	620N1	Main Pinion Shaft.....
161X21	Washer, Idler Gear Bolt.....	621N1	Tumbler Gears.....
161X21	Washer, Main Drive Shaft.....	622N1	Tumbler Compound Gear (Cone Gear Shaft)..
162X50	Springs, Tumbler Plunger Knob.....	623N1	Small Compound Gear (Cone Gear Shaft)....
164X2	Key, Lead Screw.....	624N1	Cone Shaft Gear.....
164X17	Key, Main Drive Shaft (Large).....	625N1	Small Compound Gear (Main Drive Shaft)....
164X22	Key, Cone Gear Shaft.....	626N1	Large Compound Gears (Cone Gear Shaft)...
164X86	Key, Main Drive Shaft (Small).....	627N1	Large Compound Gear (Main Drive Shaft)....
168X108	Pin, Main Drive Shaft Collar.....	628N1	Lead Screw Gear.....
168X310	Pin, Cone Gear.....	629W3N1	Lead Screw for 3-foot Bed.....
168X310	Pin, Lead Screw Thrust Collar.....	629W35N1	Lead Screw for 3½-foot Bed.....
189X33	Gear Box Expansion Plug.....	629W4N1	Lead Screw for 4-foot Bed.....
206X8	Tumbler Pinion Shaft.....	629W45N1	Lead Screw for 4½-foot Bed.....
247N1	Bolt, Idler Gear.....	650N2	Change Gear Guard for Underneath Motor Driven Lathes.....
255X20	Gear Box Oiler.....	1541N1	Index Plate.....
256X1	Cone Gear Shaft Wicking.....	2092	Babbitt for Rear Lead Screw Bracket.....
256X1	Tumbler Pinion Shaft Wicking.....	2093	Babbitt for Change Gear Guard Bracket.....

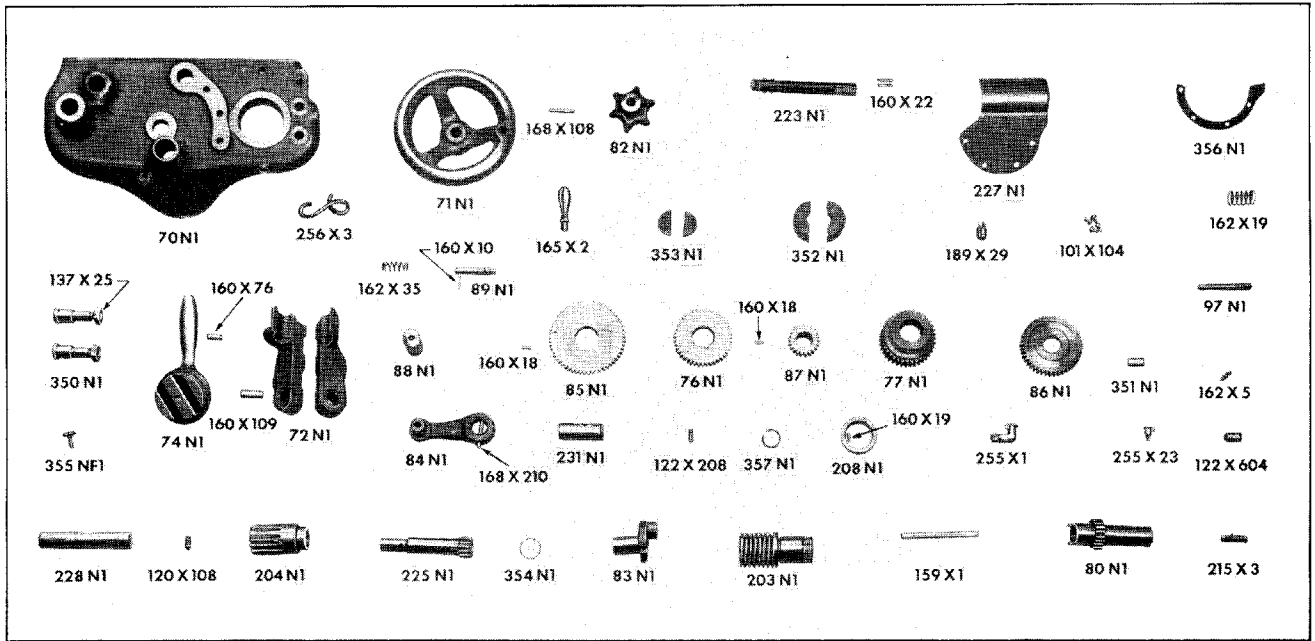

## Apron Parts

Part No.	Name of Part
70N1	Apron
71N1	Handwheel
72N1	Half-Nuts
74N1	Half-Nut Cam
76N1	Rack Pinion Gear
77N1	Worm Gear
80N1	Clutch Sleeve
82N1	Clutch Knob
83N1	Idler Gear Shifter
84N1	Idler Gear Shifter Lever
85N1	Cross-Feed Compound Gear
86N1	Idler Gear
87N1	Cross-Feed Compound Pinion
88N1	Idler Gear Shifter Knob
89N1	Idler Gear Shifter Plunger
97N1	Feed Interlock Plunger
101X104	Oil Trough Screws
120X108	Rack Pinion Stud Set Screw
122X208	Cross-Feed Compound Gear Shaft Set Screw
122X604	Cam Retainer Pin Set Screw
137X25	Half-Nut Stud Nuts
159X1	Worm Key
160X10	Idler Gear Shifter Plunger Pin
160X18	Cross-Feed Compound Pinion Pin
160X18	Rack Pinion Gear Pin
160X19	Worm Collar Pin
160X22	Clutch Screw Pin
160X76	Half-Nut Cam Stop Pin

Part No.	Name of Part
160X109	Half-Nut Pins
162X5	Cam Retainer Spring
162X19	Clutch Sleeve Spring
162X35	Shifter Plunger Spring
165X2	Handwheel Handle
168X108	Handwheel Pin
168X210	Idler Gear Shifter Lever Pin
189X29	Reservoir Plug
203N1	Apron Worm
204N1	Rack Pinion
208N1	Worm Collar
215X3	Half-Nut Oil Tube
223N1	Clutch Screw
225N1	Handwheel Pinion
227N1	Oil Trough
228N1	Rack Pinion Stud
231N1	Cross-Feed Compound Gear Shaft
255X1	Reservoir Oiler
255X23	Handwheel Oiler
256X3	Apron Worm Oil Wick
350N1	Half-Nut Studs
351N1	Half-Nut Cam Retainer Pin
352N1	Clutch Shoe
353N1	Clutch Shoe Expander
354N1	Handwheel Pinion Spring
355NF1	Clutch Knob Screw
356N1	Oil Trough Gasket
357N1	Cross-Feed Compound Gear Shaft Spring

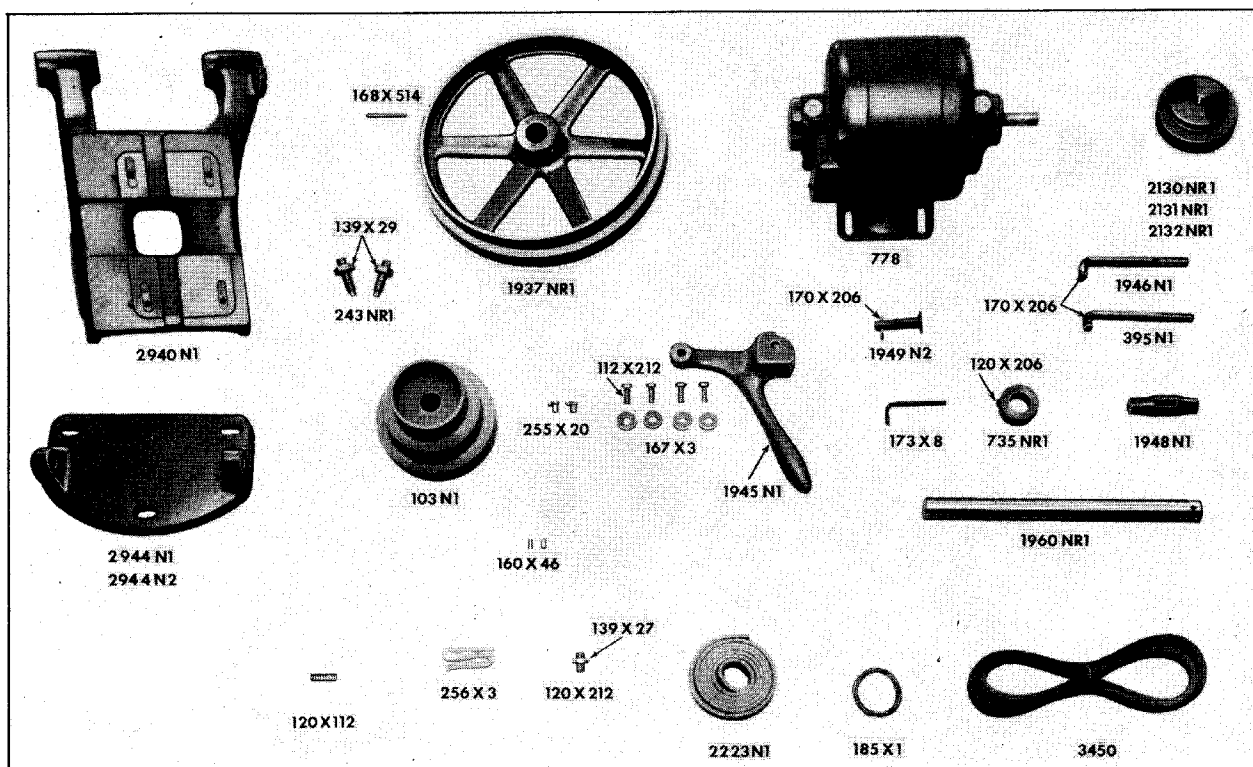

## Horizontal Motor Drive Parts

(12 Speed—Flat Belt Drive— $\frac{1}{2}$  h.p. Motor)

Part No.	Name of Part	Part No.	Name of Part
103N1	Countershaft Cone Pulley	735NR1	Countershaft Collar
112X212	Screws, Motor Mounting	778	Motor $\frac{1}{2}$ h.p. (State make, voltage, r.p.m., cycle, phase, and whether A.C. or D.C.)
120X112	Set Screw, Motor Pulley	1937NR1	Double Drive Pulley
120X206	Set Screw, Countershaft Collar	1945N1	Belt Release Lever
120X212	Set Screw, Cone Pulley	1946N1	Belt Release Rod, Front
139X27	Nut, Cone Pulley Set Screw	1948N1	Turnbuckle
139X29	Nuts, Motor Standard Pivot Screw	1949N2	Pin, Belt Release Lever
160X46	Pins, Motor Standard	1960NR1	Motor Pulley Shaft
167X3	Washers, Motor Mounting Screw	2130NR1	Combination Motor Pulley for $\frac{1}{2}$ " Shaft
168X514	Taper Pin, Countershaft Drive Pulley	2131NR1	Combination Motor Pulley for $\frac{5}{8}$ " Shaft
170X206	Cotter Pins, Belt Release Rod	2132NR1	Combination Motor Pulley for $\frac{3}{4}$ " Shaft
170X206	Cotter Pin, Belt Release Lever Pin	2223N1	Flat Leather Belt
173X8	Wrench, Set Screw	2940N1	Motor Standard
185X1	Belt Lacing	2944N2	Motor Standard Base For Master Motors
243NR1	Screws, Motor Standard Pivot	2944N1	Motor Standard Base For all other Motors
255X20	Oilers, Countershaft Bearing	3450	V-Belt, Motor to Countershaft
256X9	Felt Wicks, Countershaft Bearing Oiler		
395N1	Belt Release Rod, Rear		





# Handlerver Turret Parts

(See Illustration of Parts on Other Side of This Sheet)

Part No.	Name of Part	Part No.	Name of Part
2	Clamp Rod Nut Wrench	3003NR1	Turret Head Clamp
105X110	Screw, Stud Adjusting Nut	3004NR1	Stop Screw Index
112X212	Bolts, Tool Binder	3005NR1	Stop Screw Index End Plate
114X114	Screws, Handlerver Bracket	3006NR1	Clamping Lever
114X124	Screws, Cone Bearing	3008NR1	Turret Stud
114X616	Screws, Swivel	3009NR1	Adjusting Nut, Turret Stud
120X1006	Set Screw, Turret Stud	3010NR1	Tool Binders
122X510	Set Screw, Clamping Lever	3011NR1	Lock Bolt
125X112	Screws, Side Gib	3012NR1	Lock Bolt Bushing
126X505	Screws, Stop Screw Index End Plate	3013NR1	Lock Bolt Indexing Bushings
136X25	Nut, Clamp Rod	3014NR1	Spring, Lock Bolt
138X18	Nuts, Side Gib Screw	3015NR1	Lock Bolt Spring Retainer
139X23	Nut, Stop Screw Index Shaft	3016NR1	Lock Bolt Lever
160X6	Pin, Front Cone	3017NR1	Lock Bolt Lever Roller
160X16	Key, Front Cone Bearing	3018NR2	Pin, Lock Bolt Lever Roller
160X18	Pins, Side Gib	3019NR1	Pivot Pin, Lock Bolt Lever
160X21	Pin, Index Lever Spring	3020NR1	Lock Bolt Cam
160X21	Pin, Turret Head Gear	3021NR1	Spring, Lock Bolt Cam
160X25	Pins, Stop Screw Index End Plate	3022NR1	Pivot Pins, Lock Bolt Cam
160X48	Stop Pin, Index Lever	3023NR1	Turret Head Gear
160X48	Pin, Lock Bolt Cam	3024NR1	Stop Screw Gear
160X52	Pins, Handlerver Bracket	3026NR1	Indexing Lever
162X34	Spring, Lock Bolt Lever	3027NR1	Pivot Pin, Index Lever
168X5	Pin, Indexing Lever	3028NR1	Spring, Index Lever
168X5	Index Pin, Stop Screw	3029NR1	Stop Screws
168X6	Pin, Stop Screw Gear	3030NR1	Stop Screw Index Shaft
170X3	Cotter Pin, Lock Bolt Lever Roller Pin	3035NR1	Horizontal Gibs
173X4	Side Gib Screw Wrench	3036NR1	Side Gibs
173X6	Stop Screw Index End Plate Screw Wrench	3037NR1	Washers, Tool Binder Bolt
189X17	Stop Screw Index End Plate Screw Shoes	3118NR1	Handlerver Bracket
254X2	Key, Turret Stud	3119NR1	Swivel
255X17	Oiler, Stop Screw Index	3120NR1	Swivel Hinge
255X20	Oilers, Horizontal Gib	3121NR1	Handlerver
255X23	Oiler, Index Shaft	3122NR1	Handlerver Handle
255X41	Oiler, Turret Head Clamp	3123NR1	Stud, Swivel
256X8	Turret Base Felt Wick	3124NR1	Stud, Swivel Hinge
384N1	Swivel Bearing	3125NR1	Cone Bearings
384N1	Swivel Hinge Stud Bearings	3126NR1	Rear Cone
477NR1	Indexing Pins, Turret Head	3127NR1	Front Cone
702	Tool Binder Bolt Wrench	3128NR1	Clamp Rod
3000N1	Turret Base for 9" Lathes	3130NR1	Turret Stud Guide
3000R1	Turret Base for 10" Lathes	3131NR1	Clamping Lever Handle
3001NR1	Turret Ram	3132NR1	Screws, Horizontal Gib
3002NR1	Turret Head	3139N1	Turret Base Clamp for 9" Lathes
		3139R1	Turret Base Clamp for 10" Lathes

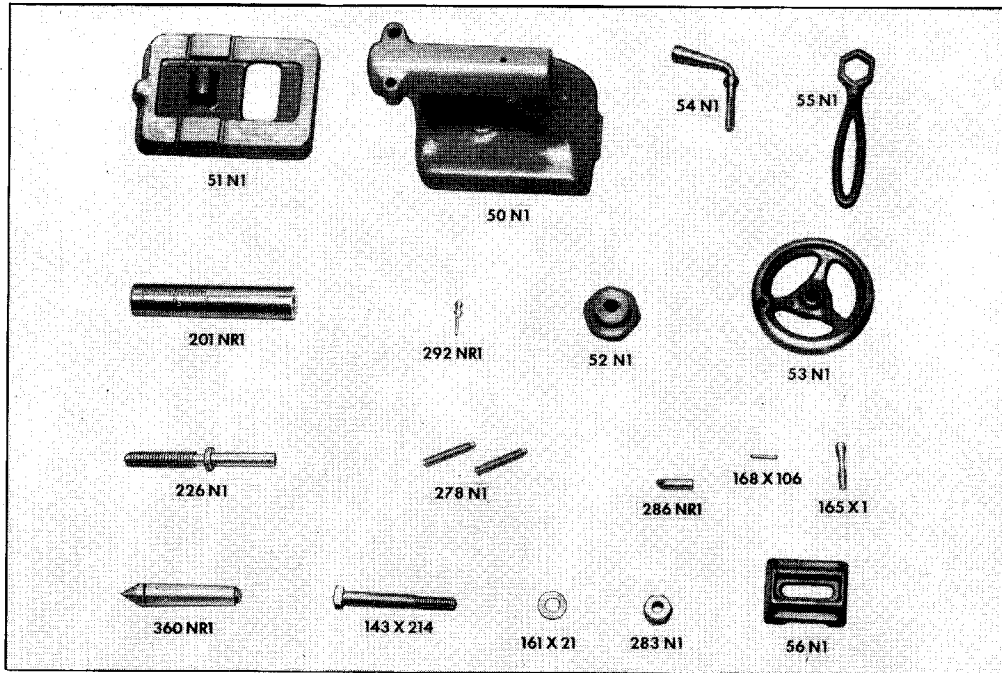

### Tailstock Parts

Part No.	Name of Part
50N1	Tailstock Top
51N1	Tailstock Base
52N1	Tailstock Nut
53N1	Tailstock Handwheel
54N1	Tailstock Binding Lever
55N1	Tailstock Wrench
56N1	Tailstock Clamp
143X214	Tailstock Clamp Bolt
161X21	Clamp Bolt Washer

Part No.	Name of Part
165X1	Tailstock Handwheel Handle
168X106	Tailstock Handwheel Pin
201NR1	Tailstock Spindle
226N1	Tailstock Screw
278N1	Tailstock Set-Over Screws
283N1	Tailstock Clamp Bolt Nut
286NR1	Tailstock Spindle Key
292NR1	Oil Reservoir Plug
360NR1	Tailstock Center

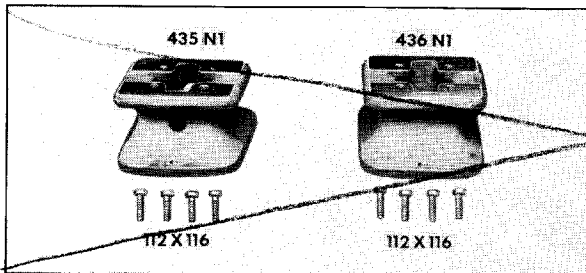

### Bench Legs

Part No.	Name of Part
112X116	Leg to Bed Screws (4 to each leg)
435N1	Bench Leg (Headstock end)
436N1	Bench Leg (Tailstock end)

SOUTH BEND LATHE WORKS

SOUTH BEND 22, INDIANA, U.S.A.

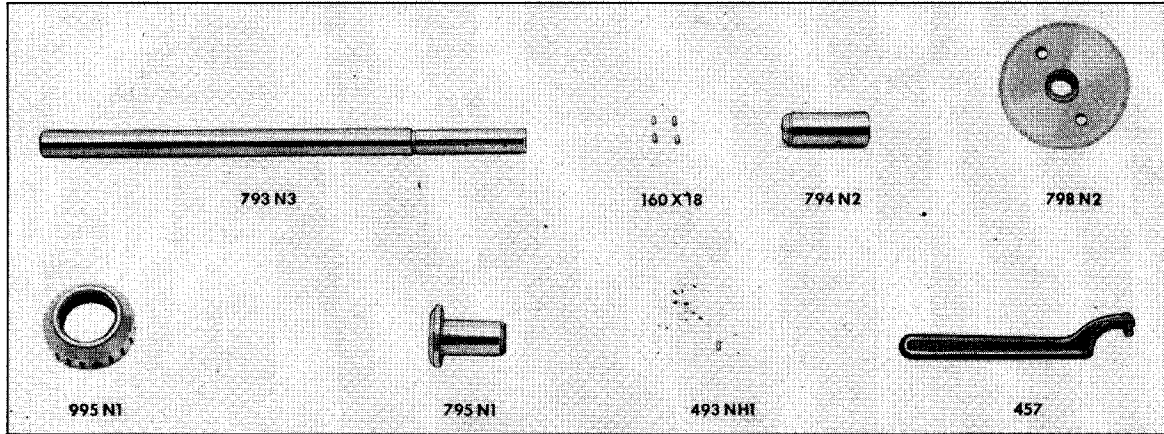

## Handwheel Draw-in Collet Attachment Parts

Part No.	Name of Part	Part No.	Name of Part
160X18	Pins, Draw Tube Sleeve .....	794N2	Sleeve, Draw Tube .....
160X18	Pins, Handwheel .....	795N1	Sleeve, Collet .....
457	Wrench, Spindle Nose Cap .....	798N2	Handwheel .....
493NH1	Key, Collet Sleeve .....	995N1	Spindle Nose Cap .....
793N3	Draw Tube .....		

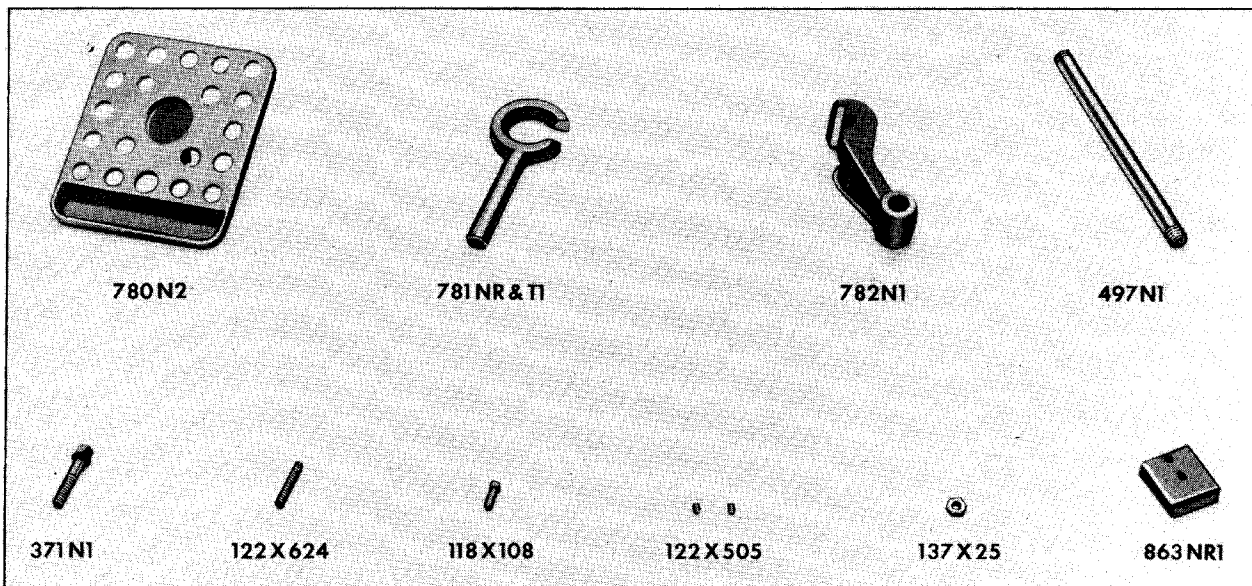

## Collet Rack Parts

Part No.	Name of Part	Part No.	Name of Part
118X108	Set Screw, Draw Tube Hook .....	497N1	Rack Pipe .....
122X505	Set Screws, Rack .....	780N2	Rack .....
122X624	Set Screw, Collet Rack Bracket Clamp .....	781NR&T1	Draw Tube Hook .....
137X25	Nut, Collet Rack Bracket Clamp Set Screw .....	782N1	Collet Rack Bracket .....
371N1	Screw, Collet Rack Bracket Clamp .....	863NR1	Collet Rack Bracket Clamp .....

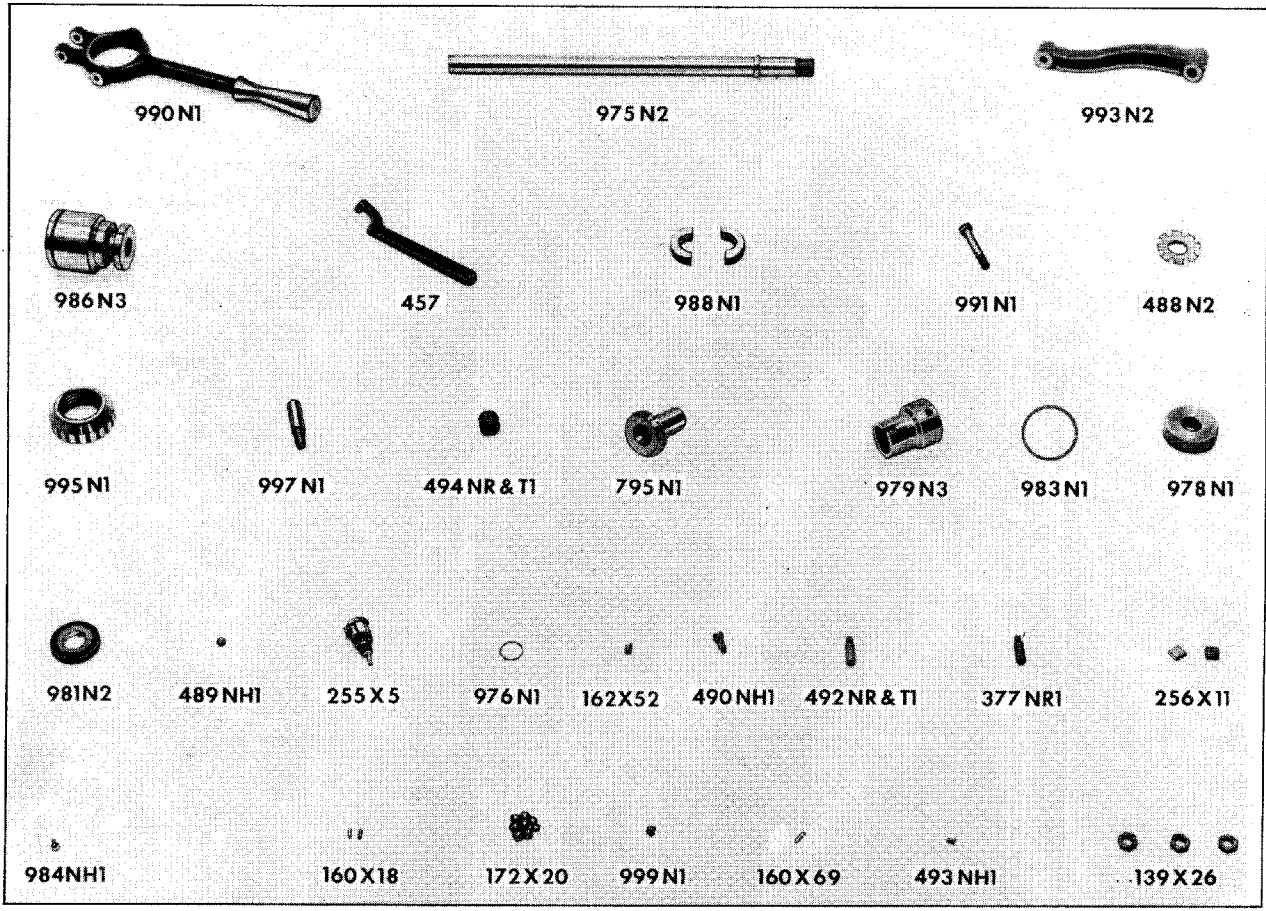

## Handlever Draw-in Collet Attachment Parts

Part No.	Name of Part	Part No.	Name of Part
139X26	Nut, Cam Yoke Lever Screw	795N1	Collet Sleeve
139X26	Nuts, Cam Yoke Bolt	975N2	Draw Tube
160X18	Pins, Cam Yoke Ring Sector	976N1	Draw Tube Snap Ring
160X69	Pin, Clutch Sleeve	978N1	Cam Stop Nut
162X52	Spring, Cam Sleeve	979N3	Cam Sleeve
172X20	Cam Balls	981N2	Draw Tube Collar
255X5	Oiler	983N1	Yoke Snap Ring
256X11	Felt Wick	986N3	Cam Yoke Cone
377NR1	Stop Screw, Cam Sleeve	988N1	Cam Yoke Ring Sectors
457	Spindle Nose Cap Wrench	990N1	Cam Yoke Lever
488N2	Cam Ball Retainer	991N1	Bolt, Cam Yoke
489NH1	Screw, Cam Sleeve	993N2	Cam Yoke Lever Bracket
490NH1	Screw, Cam Stop Nut	995N1	Spindle Nose Cap
492NR&T1	Screw, Cam Yoke Lever	997N1	Stud, Cam Yoke Lever Bracket
493NH1	Key, Collet Sleeve	999N1	Key, Cam Adjustment Sleeve
494NR&T1	Nut, Cam Yoke Lever Screw		

# NUMERICAL PRICE LIST 5223

South Bend Lathes, Drill Presses, Shapers, and Accessories

All prices listed are net f.o.b. factory at South Bend, Indiana, U.S.A.

Cat. No.	Price	Cat. No.	Price	Cat. No.	Price	Cat. No.	Price	Cat. No.	Price	Cat. No.	Price
<b>CA NUMBERS</b>											
CA46FH	\$ 19.00	CB5206H	\$154.00	CE301AR	\$ 62.00	CE852L	\$ 5.20	CE1633	\$ 3.50	CE2178	\$ 8.25
CA46LT	16.00	CB5206L	118.00	CE301AT	62.00	CE852R	5.20	CE1659	1.25	CE2181	7.25
CA2175FH	25.00	CB5206T	129.00	CE301BF	61.00	CE852S	5.20	CE1663B	47.00	CE2182	7.50
CA2175L	17.00	CB5223F	5.00	CE301BH	61.00	CE853L	6.40	CE1663C	115.00	CE2183	8.25
CA2175T	17.00	CB5223H	6.50	CE301BNK	61.00	CE853R	6.40	CE1737	171.00	CE2187	24.95
CA2180FH	34.00	CB5223L	4.00	CE301BR	61.00	CE853S	6.40	CE1744	2.40	CE2188	.70
CA2180L	23.00	CB5223T	4.50	CE301BT	61.00	CE867	8.00	CE1746	3.15	CE2190	.25
CA2180T	25.00	CB6005	60.95	CE301CF	66.00	CE868	10.25	CE1747	4.50	CE2191	2.25
CA22704RH	16.00	CB6309LH	12.00	CE301CH	66.00	CE876	1.05	CE1770H	21.00	CE2192	4.25
CA22707RH	17.00	CB6311LH	16.00	CE301CNK	66.00	CE878	1.45	CE1770K	16.00	CE2193	8.75
CA22709RH	18.00	CB6506	87.90	CE301CR	66.00	CE879	2.10	CE1770L	21.00	CE2214	23.00
CA2935	25.00	CB8050F	42.00	CE301CT	66.00	CE883L	5.75	CE1770M	21.00	CE2215	44.00
CA3005	73.60	CB8050H	47.00	CE301DH	65.00	CE883R	5.75	CE1770N	15.50	CE2216	37.00
CA3505	107.70	CB8050L	30.00	CE301DNK	65.00	CE883S	5.75	CE1770Q	21.00	CE2218	11.50
CA3506	111.00	CB8050T	35.00	CE301DR	65.00	CE884L	7.20	CE1770R	19.00	CE2220	124.50
CA3507	125.30	<b>CD NUMBERS</b>		CE301DT	65.00	CE884R	7.20	CE1777	3.30	CE2225	8.75
CA3509	159.40	CD400B	117.00	CE303CF	70.00	CE884S	7.20	CE1778	4.70	CE2228	53.00
CA4006	56.00	CD400F	134.00	CE303CH	70.00	CE890	.10	CE1779	2.25	CE2235	12.40
CA4206	86.80	CD401B	82.00	CE303CNK	70.00	CE891	.10	CE1780	38.00	CE2238	22.55
CA4207	97.80	CD401F	96.00	CE303CR	70.00	CE893	10.80	CE1780D	7.40	CE2241	39.90
CA4209	106.60	CD402B	84.00	CE303CT	70.00	CE894	12.80	CE1829	5.00	CE2267	.80
CA4210	120.90	CD402F	99.00	CE303DF	70.00	CE907	16.50	CE1834	5.50	CE2268	1.60
CA4212	137.40	CD403B	88.00	CE303DH	70.00	CE925	19.75	CE1838	5.00	CE2269	3.10
CA4306F	67.00	CD403F	103.00	CE303DNK	70.00	CE1192	.95	CE1839	5.50	CE2290	79.50
CA4306H	67.00	CD414B	113.00	CE303DR	70.00	CE1196	109.00	CE1881	297.00	CE2293	41.00
CA4306L	67.00	CD414F	130.00	CE303DT	70.00	CE1200	7.00	CE1882	303.00	CE2300	1.10
CA4306T	67.00	CD451F	214.00	CE303FF	70.00	CE1201	8.00	CE1889	5.60	CE2301	1.60
CA5206F	142.00	CD452F	412.00	CE303FH	70.00	CE1202	13.00	CE1890	10.00	CE2302	1.10
CA5206H	154.00	CD453F	639.00	CE303FNK	70.00	CE1205	182.00	CE1896	2.50	CE2303	1.60
CA5206L	118.00	CD454F	734.00	CE303FR	70.00	CE1206	25.00	CE1897	3.40	CE2304	1.10
CA5206T	129.00	CD9125	6.50	CE303FT	70.00	CE1209	212.00	CE1904	9.10	CE2305	1.60
CA5223F	5.00	CD9126	4.70	CE311B	10.00	CE1217	174.00	CE1905	9.10	CE2306	1.10
CA5223H	6.50	CD9127	4.10	CE311D	10.00	CE1219	220.00	CE1906	9.10	CE2307	1.60
CA5223L	4.00	CD9135A	15.00	CE313D	10.00	CE1242	65.00	CE2000K	159.00	CE2308	1.10
CA5223T	4.50	CD9135B	15.00	CE313F	10.00	CE1245	65.00	CE2000L	159.00	CE2309	1.60
CA6005	60.95	CD9136	12.95	CE313K	10.00	CE1263	11.00	CE2001A	131.00	CE2312K	7.00
CA6309LH	12.00	CD9137	13.00	CE313VA	10.00	CE1290	186.00	CE2001B	128.00	CE2312N	6.35
CA6311LH	16.00	CD9138	15.75	CE327	10.00	CE1299	105.00	CE2001C	132.00	CE2313K	7.25
CA6506	87.90	CD9147	70.00	CE328	15.00	CE1305	.45	CE2001D	131.00	CE2314K	1.75
CA8050F	42.00	CD9148	85.00	CE406	7.00	CE1313	.60	CE2002C	145.00	CE2315K	8.75
CA8050H	47.00	CD9152	4.10	CE423	7.85	CE1316	.80	CE2002D	145.00	CE2315N	8.60
CA8050L	23.00	<b>CE NUMBERS</b>		CE431	9.30	CE1363	.50	CE2003C	145.00	CE2315R	8.85
CA8050T	35.00	CE18	7.00	CE432	12.25	CE1365	.60	CE2003D	145.00	CE2316F	12.70
		CE91F	8.75	CE601BF	155.00	CE1366	.80	CE2003E	145.00	CE2316H	17.45
		CE91H	10.00	CE601BH	155.00	CE1413F	18.00	CE2003F	145.00	CE2316R	9.15
		CE91N	7.50	CE601BNK	155.00	CE1413H	19.00	CE2003G	145.00	CE2316T	12.40
		CE91R	7.50	CE601BR	155.00	CE1413NK	12.00	CE2003H	145.00	CE2316V	19.80
		CE91T	8.75	CE601BT	155.00	CE1413R	13.00	CE2028	.25	CE2317H	23.65
		CE101	5.50	CE648	6.65	CE1413T	15.00	CE2029	.35	CE2323K	1.75
		CE109	8.75	CE650	.80	CE1433	.60	CE2041	.95	CE2323N	1.75
		CE144	15.00	CE665	9.00	CE1475L	2.10	CE2042	.95	CE2325	1.40
		CE160	3.25	CE667S1	7.00	CE1475NK	1.35	CE2043	.95	CE2326	1.50
		CE161	4.25	CE667S2	7.00	CE1475QH	3.25	CE2044	1.45	CE2338	3.00
		CE162	5.35	CE667S3	7.00	CE1475R	1.75	CE2047	29.70	CE2339	3.00
		CE163	7.70	CE667S4	7.00	CE1500	1.10	CE2087	.95	CE2340	3.00
		CE199	.10	CE700	7.00	CE1501	1.60	CE2088	.95	CE2341	3.00
		CE219	5.50	CE736L	4.55	CE1512F	24.00	CE2102	24.00	CE2342	3.00
		CE220	7.50	CE736R	4.55	CE1512H	24.00	CE2103	24.00	CE2343	4.00
		CE250	.10	CE736S	4.55	CE152K	19.25	CE2105	7.00	CE2344	4.00
		CE300KF	86.00	CE777	.10	CE1512N	18.50	CE2107	7.00	CE2345	4.00
		CE300KH	86.00	CE789	5.75	CE1512R	20.00	CE2119	7.60	CE2346	4.00
		CE300KNK	86.00	CE790	11.00	CE1512T	22.00	CE2121	21.90	CE2347	4.00
		CE300KR	86.00	CE800	.10	CE1512V	36.00	CE2130	178.00	CE2360	1.10
		CE300KT	86.00	CE820	5.00	CE1600	.85	CE2131	178.00	CE2361	1.10
		CE300LF	86.00	CE829	4.00	CE1602	.85	CE2147	137.00	CE2362	1.10
		CE300LH	86.00	CE830	4.00	CE1603	.85	CE2148	137.00	CE2363	1.10
		CE300LNK	86.00	CE833R	2.50	CE1608NR	11.15	CE2160	5.60	CE2364	1.10
		CE300LR	86.00	CE833S	2.50	CE1608TH	11.75	CE2161	7.65	CE2365	1.10
		CE300LT	86.00	CE845	4.20	CE1615NR	7.75	CE2162	11.50	CE2366	1.10
		CE301AF	62.00	CE846L	4.55	CE1615TH	8.40	CE2169	.60	CE2367	1.10
		CE301AH	62.00	CE846R	4.55	CE1620B	40.00	CE2171	2.65	CE2368	1.10
		CE301ANK	62.00	CE846S	4.55	CE1620C	100.00	CE2172	5.00	CE2369	1.10
				CE847L	2.10	CE1621B	43.00	CE2173	9.50	CE2370	2.90
				CE847R	2.10	CE1621C	110.00	CE2174	5.60	CE2371	3.50
				CE847S	2.10	CE1629	1.40	CE2176	7.25	CE2372	5.25
						CE1632	2.25	CE2177	7.50	CE2373	7.85

**NUMERICAL PRICE LIST 5223 — (Cont'd)**

Cat. No.	Price	Cat. No.	Price	Cat. No.	Price	Cat. No.	Price	Cat. No.	Price	Cat. No.	Price
CE2374	\$ 12.75	CE2547H	\$ 84.00	CE2703LQ	\$ 10.35	CE2843	\$ 4.70	CE3648	\$ 4.50	CE3944	\$ 3.90
CE2375	20.00	CE2548A	164.00	CE2703NK	3.85	CE2844	5.50	CE3655	1.00	CE3945	4.35
CE2376	40.00	CE2548B	164.00	CE2703RT	8.85	CE2850	1.80	CE3658	.80	CE3946	4.35
CE2377	2.30	CE2548C	164.00	CE2704LQ	10.35	CE2851	2.25	CE3659	1.00	CE3947	4.80
CE2378	2.30	CE2548D	164.00	CE2704MH	11.80	CE2852	2.35	CE3660	1.05	CE3948	4.80
CE2379	2.30	CE2549	199.00	CE2704NK	3.85	CE2853	2.85	CE3661	1.20	CE3949	5.05
CE2380	2.30	CE2550	199.00	CE2704RT	8.85	CE2855	4.40	CE3808	9.00	CE3950	5.30
CE2381	2.30	CE2553	93.00	CE2705LQ	10.35	CE2856	4.55	CE3809	9.00	CE3951	5.30
CE2385	.06	CE2553NF	78.00	CE2705MH	11.80	CE2857	4.70	CE3810	9.40	CE3952	5.55
CE2386	.07	CE2554	5.50	CE2705RT	8.85	CE2858	5.50	CE3811	10.85	CE3953	5.85
CE2387	.08	CE2555	8.40	CE2706MH	11.80	CE2930F	39.00	CE3812	12.30	CE3954	5.85
CE2388	.09	CE2556	8.40	CE2707LQ	10.35	CE2930H	40.00	CE3820	.90	CE3955	6.20
CE2389	.13	CE2557	8.40	CE2707MH	11.80	CE2930NK	20.00	CE3821	.95	CE4521A	1.00
CE2390	.20	CE2558	8.40	CE2707RT	8.85	CE2930R	21.00	CE3822	1.10	CE4522A	1.10
CE2391	.06	CE2559	8.40	CE2708LQ	10.35	CE2930T	28.00	CE3823	1.20	CE4523A	1.15
CE2392	.06	CE2560	12.60	CE2708MH	11.80	CE2931	99.00	CE3824	1.35	CE4527A	1.15
CE2393	27.00	CE2563	65.00	CE2708RT	8.85	CE2935LQ	14.15	CE3825	1.70	CE4527B	1.20
CE2396	3.10	CE2564	65.00	CE2709LQ	10.35	CE2935MH	15.25	CE3826	1.00	CE4528B	1.23
CE2397	3.40	CE2565	189.00	CE2709NK	3.85	CE2935NK	6.50	CE3827	1.15	CE4529B	1.25
CE2398	3.10	CE2566	197.00	CE2709RT	8.85	CE2935RT	13.00	CE3828	1.25	CE4530B	1.28
CE2399	4.10	CE2567	171.00	CE2710LQ	10.35	CE3150	1.60	CE3829	1.50	CE4531B	1.29
CE2401	2.80	CE2568	180.00	CE2710MH	11.80	CE3151	1.60	CE3830	1.75	CE4532B	1.31
CE2402	3.70	CE2569	74.00	CE2710RT	8.85	CE3152	1.60	CE3831	1.90	CE4535C	1.80
CE2413	3.70	CE2569NF	59.00	CE2711MH	11.80	CE3153	1.60	CE3832	2.15	CE4537C	1.87
CE2414	4.10	CE2570	82.00	CE2714C	100.00	CE3154	1.60	CE3833	2.40	CE4538C	1.90
CE2416	3.70	CE2570NF	67.50	CE2715C	110.00	CE3155	1.60	CE3834	2.70	CE4540C	2.06
CE2417	4.10	CE2571	122.00	CE2716C	115.00	CE3156	1.85	CE3835	3.70	CE4541C	2.11
CE2419	4.80	CE2572	122.00	CE2717C	100.00	CE3157	1.85	CE3836	5.00	CE4542C	2.11
CE2420	6.00	CE2573	89.00	CE2718C	110.00	CE3158	1.85	CE3837	.90	CE4543C	2.25
CE2421	8.65	CE2574	97.00	CE2734	.75	CE3159	1.85	CE3838	.95	CE4544B	1.65
CE2422	2.50	CE2575	137.00	CE2735	1.05	CE3160	1.85	CE3839	1.10	CE4544C	2.24
CE2423	3.40	CE2576	137.00	CE2736	1.15	CE3161	1.85	CE3840	1.20	CE4545B	1.69
CE2424	2.80	CE2577	97.00	CE2737	1.20	CE3175	5.00	CE3841	1.35	CE4545C	2.29
CE2425	3.70	CE2578	184.00	CE2738	1.35	CE3176	5.75	CE3842	1.70	CE4546B	2.20
CE2432	42.90	CE2579	101.00	CE2739	.75	CE3177	6.50	CE3843	1.00	CE4546C	2.39
CE2435	74.80	CE2580	86.00	CE2740	1.00	CE3225G	41.50	CE3844	1.15	CE4547B	1.73
CE2441	38.45	CE2580NF	71.50	CE2741	1.90	CE3225H	41.50	CE3845	1.25	CE4548B	1.75
CE2442	34.95	CE2625C	71.50	CE2742	1.90	CE3227C	41.50	CE3846	1.50	CE4549B	1.76
CE2443	68.70	CE2625D	71.50	CE2743	1.90	CE3227D	41.50	CE3847	1.75	CE4549C	2.39
CE2450F	13.00	CE2625E	71.50	CE2744	2.30	CE3227E	41.50	CE3848	1.90	CE4550C	2.56
CE2450H	13.75	CE2625F	71.50	CE2745	1.90	CE3227F	41.50	CE3849	2.15	CE4551C	2.56
CE2450NK	5.50	CE2627G	71.50	CE2746	2.30	CE3228	54.00	CE3850	2.40	CE4552C	2.61
CE2450R	7.50	CE2627H	71.50	CE2747	1.50	CE3229	53.00	CE3851	2.70	CE4553B	1.87
CE2450T	10.00	CE2628A	126.00	CE2748	1.90	CE3230	59.50	CE3852	3.70	CE4554B	1.84
CE2455	1.35	CE2628B	126.00	CE2749	1.90	CE3231	69.00	CE3853	5.00	CE4554C	2.70
CE2456	2.00	CE2628C	126.00	CE2757	1.75	CE3236	3.45	CE3856	.60	CE4555C	2.72
CE2457	7.25	CE2628D	126.00	CE2758	1.75	CE3240	60.00	CE3857	.80	CE4556B	1.84
CE2470	7.50	CE2629	175.00	CE2759	1.75	CE3242	32.00	CE3858	1.00	CE4558B	1.93
CE2471	13.75	CE2630	175.00	CE2769	1.75	CE3243	31.50	CE3859	1.20	CE4559C	2.78
CE2472	11.50	CE2640	1.35	CE2774	1.75	CE3250C	29.50	CE3860	1.60	CE4560B	1.98
CE2473	20.75	CE2641	2.00	CE2776	3.00	CE3250D	29.50	CE3861	2.20	CE4564B	2.09
CE2474	13.25	CE2642	7.25	CE2777	6.10	CE3252	29.00	CE3893	6.15	CE4568B	2.17
CE2475	23.90	CE2643	7.50	CE2778	11.75	CE3253	28.50	CE3894	6.35	CE4570B	2.25
CE2476	26.40	CE2644	13.75	CE2801C	55.00	CE3254	48.50	CE3895	6.35	CE4571B	2.29
CE2477	50.60	CE2645	11.50	CE2801D	55.00	CE3256B	16.00	CE3896	7.30	CE4578B	2.45
CE2478	39.60	CE2646	20.75	CE2801E	55.00	CE3369	50.50	CE3897	8.45	CE4580B	2.56
CE2479	78.10	CE2647	13.25	CE2801F	55.00	CE3372	178.00	CE3900	16.25	CE4598B	3.19
CE2482	70.40	CE2648	23.90	CE2803G	56.00	CE3480	2.75	CE3901	19.00	CE4901	7.25
CE2483	139.70	CE2650FH	1.45	CE2803H	56.00	CE3481	5.00	CE3903	16.25	CE4909E	64.00
CE2485	17.20	CE2650NK	.60	CE2804	70.00	CE3482	6.65	CE3904	19.00	CE4909F	64.00
CE2486	15.70	CE2650R	.70	CE2805	70.00	CE3483	2.75	CE3920	4.40	CE4909S	66.50
CE2487	30.75	CE2650T	1.30	CE2806A	76.00	CE3484	5.00	CE3921	5.85	CE4910B	37.50
CE2501	5.20	CE2653FH	1.30	CE2806B	76.00	CE3485	6.65	CE3922	6.10	CE4910D	37.50
CE2502	7.00	CE2653NK	.60	CE2807	93.00	CE3531	.13	CE3923	6.45	CE4911A	40.00
CE2503	14.00	CE2653R	.70	CE2808	96.00	CE3532	.16	CE3924	6.95	CE4911C	40.00
CE2525	.85	CE2653T	1.00	CE2825	1.65	CE3533	.35	CE3925	7.25	CE4912C	38.50
CE2526	1.10	CE2655	.70	CE2826	1.95	CE3534	.45	CE3926	8.15	CE4912D	38.50
CE2527	1.10	CE2656	1.50	CE2827	2.20	CE3535	.65	CE3927	8.55	CE4913E	42.00
CE2534	10.75	CE2657	.75	CE2828	2.70	CE3536	.95	CE3930	9.00	CE4913F	42.00
CE2535	20.85	CE2658	.90	CE2830	4.15	CE3537	1.30	CE3931	9.45	CE4913S	42.00
CE2536	20.65	CE2670	1.10	CE2831	4.30	CE3538	1.90	CE3932	9.70	CE4914C	47.50
CE2537	39.05	CE2671	1.50	CE2832	4.40	CE3581A	62.50	CE3933	10.50	CE4914D	47.50
CE2540	37.70	CE2675	2.20	CE2833	5.25	CE3582D	61.50	CE3934	11.35	CE4914E	47.50
CE2541	69.85	CE2693	1.95	CE2835	1.80	CE3583B	56.00	CE3935	18.65	CE4914F	47.50
CE2545C	84.00	CE2694	2.75	CE2836	2.25	CE3584D	55.50	CE3936	19.90	CE4915Q	62.00
CE2545D	84.00	CE2695	2.95	CE2837	2.35	CE3644	5.00	CE3940	3.50	CE4916R	62.00
CE2545E	84.00	CE2696	3.25	CE2838	2.85	CE3645	2.95	CE3941	3.50	CE4920B	51.50
CE2545F	84.00	CE2697	5.25	CE2841	4.40	CE3646	3.10	CE3942	3.50	CE4920D	51.50
CE2547G	84.00	CE2698	7.50	CE2842	4.55	CE3647	3.70	CE3943	3.90	CE4921A	57.50

**NUMERICAL PRICE LIST 5223 — (Cont'd)**

CL428NK \$94.50  
CL428NKME 94.80  
CL1283N 21.00

Cat. No.	Price	Cat. No.	Price	Cat. No.	Price	Cat. No.	Price	Cat. No.	Price
CE4921C	\$ 57.50	CE6113	\$ 4.83	CE6306.Z	\$ 7.18	<b>CL NUMBERS</b>		CL315ZD	\$ 443.00
CE4922Y	75.50	CE6115	13.02	CE6312.A	5.25	CL2CT	\$ 2897.00	CL331BR	185.00
CE4922Z	75.50	CE6121	11.97	CE6312.B	5.50	CL2DT	2951.00	CL331DR	188.00
CE4924C	47.50	CE6129	23.73	CE6312.C	5.50	CL15A	242.00	CL333DR	198.00
CE4924D	47.50	CE6212.1	5.25	CE6312.D	5.67	CL15AB	227.00	CL333FR	198.00
CE4924E	47.50	CE6212.2	5.25	CE6312.E	5.67	CL15R	269.00	CL344Z	543.00
CE4924F	47.50	CE6212.3	5.00	CE6312.F	6.30	CL15RB	254.00	CL344ZD	575.00
CE4924S	47.50	CE6212.4	5.00	CE6312.G	6.30	CL15Y	204.00	CL353Z	571.00
CE4930	74.00	CE6212.5	5.00	CE6312.H	6.72	CL15YB	189.00	CL353ZD	603.00
CE4931	77.00	CE6212.6	5.00	CE6312.I	6.72	CL15Z	223.00	CL367Z	635.00
CE5916	7.65	CE6212.7	4.58	CE6312.J	6.72	CL15ZB	208.00	CL367ZD	665.00
CE5917	10.35	CE6212.8	4.58	CE6312.K	6.93	CL44A	373.00	CL370Z	704.00
CE5918	11.75	CE6212.9	4.58	CE6326	21.21	CL44AB	358.00	CL370ZD	734.00
CE5919	13.30	CE6212.10	4.41	CE6342	.95	CL44R	400.00	CL377Z	475.00
CE5920	15.65	CE6212.11	4.41	CE6343	.95	CL44RB	385.00	CL377ZD	506.00
CE5921	8.20	CE6212.12	4.41	CE6344	.95	CL44Y	335.00	CL415A	227.00
CE5922	10.50	CE6212.13	4.07	CE6345	1.10	CL44YB	320.00	CL415R	254.00
CE5923	12.10	CE6212.14	4.07	CE6346	1.10	CL44Z	354.00	CL415Y	189.00
CE5924	14.50	CE6212.15	4.07	CE6347	1.10	CL44ZB	339.00	CL415Z	208.00
CE5925	16.25	CE6212.16	3.91	CE6348	1.20	CL46L	11.00	CL444A	358.00
CE5926	8.85	CE6212.17	3.91	CE6349	1.20	CL46MH	12.75	CL444R	385.00
CE5927	11.55	CE6212.18	3.78	CE6350	1.20	CL46NK	4.50	CL444Y	320.00
CE5928	13.30	CE6212.19	3.65	CE6351	1.30	CL46Q	11.75	CL444Z	339.00
CE5929	15.30	CE6212.20	3.65	CE6352	1.30	CL77A	305.00	CL477A	289.00
CE5930	16.85	CE6212.21	3.65	CE6353	1.30	CL77AB	289.00	CL477R	316.00
CE5936	8.00	CE6212.22	3.49	CE6354	1.85	CL77R	332.00	CL500K	180.00
CE5937	10.45	CE6212.23	3.49	CE6355	1.85	CL77RB	316.00	CL500L	180.00
CE5938	12.10	CE6212.24	3.40	CE6356	1.85	CL77Y	267.00	CL501A	151.00
CE5939	13.90	CE6212.25	3.28	CE6357	2.20	CL77YB	251.00	CL501B	149.00
CE5940	16.25	CE6212.26	3.28	CE6358	2.20	CL77Z	286.00	CL501C	152.00
CE5960	10.15	CE6212.27	3.28	CE6359	2.20	CL77ZB	270.00	CL501D	151.00
CE5961	14.35	CE6212.28	3.28	CE6360	4.00	CL117C	1953.00	CL502C	166.00
CE5962	15.75	CE6212.29	3.02	CE6361	4.00	CL117D	2000.00	CL502D	166.00
CE5963	17.30	CE6212.30	3.02	CE6362	4.00	CL117E	2047.00	CL503C	166.00
CE5964	19.65	CE6212.31	2.77	CE6363	4.65	CL117G	2182.00	CL503D	166.00
CE5965	10.50	CE6212.32	2.77	CE6364	4.65	CL117H	2317.00	CL503E	166.00
CE5966	14.45	CE6212.33	2.77	CE6365	4.65	CL145A	1326.00	CL503F	166.00
CE5967	16.10	CE6212.34	2.65	CE6366	4.75	CL145B	1371.00	CL503G	166.00
CE5968	17.90	CE6212.35	2.65	CE6367	4.75	CL145C	1416.00	CL503H	166.00
CE5969	20.25	CE6212.36	2.60	CE6368	4.75	CL145D	1461.00	CL510K	180.00
CE5970	10.70	CE6212.37	2.48	CE6369	5.00	CL155C	1953.00	CL510L	180.00
CE5971	14.50	CE6212.38	2.48	CE6370	5.00	CL155D	2000.00	CL511A	151.00
CE5972	16.10	CE6212.39	2.48	CE6371	5.00	CL155E	2047.00	CL511B	149.00
CE5973	18.50	CE6212.40	2.35	CE8520	.80	CL155G	2182.00	CL511C	152.00
CE5974	20.25	CE6212.41	2.35	CE8521	4.50	CL155H	2317.00	CL511D	151.00
CE5975	11.35	CE6212.42	2.31	CE8522	1.75	CL179C	2212.00	CL512C	166.00
CE5976	15.55	CE6212.43	2.18	CE8523	9.50	CL179D	2259.00	CL512D	166.00
CE5977	17.30	CE6212.44	2.18	CE9100	25.00	CL179E	2306.00	CL513C	166.00
CE5978	19.30	CE6212.45	2.18	CE9105	4.50	CL179G	2441.00	CL513D	166.00
CE5979	20.85	CE6212.46	2.10	CE9106	12.95	CL179H	2576.00	CL513E	166.00
CE6106.19	3.78	CE6212.47	2.10	CE9107	3.60	CL185B	1642.00	CL513F	166.00
CE6106.20	4.12	CE6212.48	2.10	CE9110	1.10	CL185C	1689.00	CL513G	166.00
CE6106.21	4.54	CE6212.49	2.10	CE9130	17.00	CL185D	1736.00	CL513H	166.00
CE6106.22	4.96	CE6212.50	2.02	CE9131	17.00	CL185E	1783.00	CL515A	254.00
CE6106.23	5.38	CE6212.51	2.02	CE9133	4.40	CL187A	1069.00	CL515R	281.00
CE6106.24	5.80	CE6212.52	2.02	CE9140	1.60	CL187AB	1164.00	CL515Y	216.00
CE6106.25	6.30	CE6212.53	2.02	CE9141	23.00	CL187R	1097.00	CL515Z	235.00
CE6106.26	6.85	CE6212.54	2.02	CE9144	49.00	CL187RB	1192.00	CL519K	78.00
CE6106.27	7.39	CE6212.55	2.02	CE9145	70.00	CL187Y	1029.00	CL519N	74.00
CE6106.28	7.90	CE6212.56	2.02	CE9146	85.00	CL187YB	1112.00	CL519R	87.00
CE6106.29	8.40	CE6212.57	2.02	CE9150	93.50	CL187Z	1049.00	CL544A	385.00
CE6106.30	8.95	CE6212.58	2.02	CE9151	11.20	CL198C	1132.00	CL544R	412.00
CE6106.31	9.58	CE6212.59	2.02	CE9153	7.00	CL198D	2212.00	CL544Y	347.00
CE6106.32	10.21	CE6212.60	2.02	CE9154	7.50	CL198E	2259.00	CL544Z	366.00
CE6112.4	2.02	CE6260	18.48	CE9155	8.00	CL198F	2306.00	CL577A	317.00
CE6112.5	2.10	CE6306.L	3.70	CE9156	92.50	CL198G	2441.00	CL577R	344.00
CE6112.6	2.31	CE6306.M	3.78	CE9157	44.00	CL198H	2576.00	CL577Y	279.00
CE6112.7	2.65	CE6306.N	3.99	CE9158	3.75	CL199A	933.00	CL577Z	298.00
CE6112.8	3.02	CE6306.O	4.41	CE9159	4.00	CL199AB	1028.00	CL615A	252.00
CE6112.9	3.28	CE6306.P	4.54	CE9160	5.15	CL199R	961.00	CL615R	279.00
CE6112.10	3.49	CE6306.Q	4.96	CE9161	5.60	CL199RB	1056.00	CL615Y	214.00
CE6112.11	3.78	CE6306.R	4.96	CE9162	5.60	CL199Y	893.00	CL615Z	233.00
CE6112.12	4.07	CE6306.S	5.38	CE9163	5.60	CL199YB	976.00	CL644A	383.00
CE6112.13	4.58	CE6306.T	5.38	CE9609E	64.00	CL199Z	913.00	CL644R	410.00
CE6112.14	5.00	CE6306.U	5.80	CE9609F	64.00	CL199ZB	996.00	CL644Y	345.00
CE6112.15	5.25	CE6306.V	6.17	CE9609S	66.50	CL205RT	3.50	CL644Z	364.00
CE6112.16	5.67	CE6306.W	6.30	CE9640	10.00	CL315Z	412.00	CL653A	355.00
CE6112.17	6.30	CE6306.X	6.68						
CE6112.18	6.93	CE6306.Y	6.68						



**NUMERICAL PRICE LIST 5223—(Cont'd)**

Cat. No.	Price	Cat. No.	Price	Cat. No.	Price	Cat. No.	Price	Cat. No.	Price	Cat. No.	Price
CL1284N	\$ 21.00	CL1991D	\$ 62.00	CL2195NK	\$ 29.00	CL2444A	\$ 375.00	CL4006R	\$ 45.10	CL8145D	\$1892.00
CL1297A	32.00	CL1991E	69.00	CL2195R	29.00	CL2444R	402.00	CL4206LQ	77.00	CL8155C	2443.00
CL1297R	33.00	CL1991G	83.00	CL2200P	224.00	CL2444Y	337.00	CL4206NK	69.85	CL8155D	2497.00
CL1297Y	27.00	CL1991H	106.00	CL2224	6.00	CL2444Z	356.00	CL4206R	75.90	CL8155E	2551.00
CL1297Z	29.00	CL2020A	78.00	CL2250F	6.50	CL2477A	306.00	CL4207LQ	88.00	CL8185B	2091.00
CL1353F	11.75	CL2020R	79.00	CL2250H	7.00	CL2477R	333.00	CL4207MH	89.10	CL8185C	2144.00
CL1353H	13.00	CL2020Y	74.00	CL2250NK	4.70	CL2477Y	268.00	CL4207R	86.90	CL8185D	2197.00
CL1353N	5.75	CL2020Z	76.00	CL2250R	5.00	CL2477Z	287.00	CL4209MH	97.90	CL8185E	2250.00
CL1353R	8.75	CL2022A	91.00	CL2250T	5.60	CL2515A	270.00	CL4209Q	96.80	CL8187A	1432.00
CL1353T	10.00	CL2022B	93.00	CL2253K	16.00	CL2515R	297.00	CL4210MH	112.20	CL8187AB	1491.00
CL1353V	19.00	CL2022C	95.00	CL2253N	15.00	CL2515Y	232.00	CL4212H	128.70	CL8187Y	1390.00
CL1377A	34.00	CL2022D	100.00	CL2254K	16.00	CL2515Z	251.00	CL4306H	61.00	CL8187YB	1439.00
CL1377R	35.00	CL2022B	99.00	CL2254N	15.00	CL2544A	401.00	CL4306K	26.00	CL8187Z	1411.00
CL1377Y	29.00	CL2023C	105.00	CL2255K	16.00	CL2544R	428.00	CL4306L	61.00	CL8187ZB	1459.00
CL1377Z	32.00	CL2023D	109.00	CL2255N	15.00	CL2544Y	363.00	CL4306M	61.00	CL8199A	1284.00
CL1483LQ	17.00	CL2023E	115.00	CL2256K	16.00	CL2544Z	382.00	CL4306N	17.50	CL8199AB	1343.00
CL1483NK	11.00	CL2024C	106.00	CL2256N	15.00	CL2577A	332.00	CL4306Q	61.00	CL8199Y	1242.00
CL1483R	15.00	CL2024D	113.00	CL2258H	38.00	CL2577R	359.00	CL4306R	49.00	CL8199YB	1291.00
CL1545F	209.00	CL2024E	120.00	CL2258V	46.00	CL2577Y	294.00	CL5200K	3.00	CL8199Z	1263.00
CL1545FME	209.00	CL2024G	134.00	CL2261K	16.00	CL2577Z	313.00	CL5200N	2.75	CL8199ZB	1311.00
CL1545H	234.00	CL2024H	156.00	CL2261N	15.00	CL2680F	80.00	CL5206H	148.00	CL8344Z	743.00
CL1545HME	234.00	CL2027H	155.00	CL2263K	16.00	CL2680FME	80.00	CL5206K	82.00	CL8344ZD	775.00
CL1545R	171.00	CL2027HME	155.00	CL2263N	15.00	CL2680H	93.00	CL5206L	112.00	CL8644A	583.00
CL1545RME	171.00	CL2027T	143.00	CL2265NK	16.50	CL2680HME	93.00	CL5206M	136.00	CL8644Y	545.00
CL1545T	195.00	CL2027TME	143.00	CL2266H	51.00	CL2680NK	43.00	CL5206N	71.00	CL8644Z	564.00
CL1545TME	195.00	CL2030K	99.00	CL2266V	59.00	CL2680NKME	43.00	CL5206Q	124.00	CL8670A	699.00
CL1611K	254.00	CL2030KME	99.00	CL2284F	56.00	CL2680R	55.00	CL5206R	100.00	CL8670Y	661.00
CL1611N	248.00	CL2030N	93.00	CL2284H	61.00	CL2680RME	55.00	CL5223F	4.25	CL8670Z	680.00
CL1611R	260.00	CL2030NME	93.00	CL2284NK	13.00	CL2680T	68.00	CL5223H	5.25		
CL1611T	280.00	CL2030R	112.00	CL2284R	44.00	CL2680TME	68.00	CL5223NK	2.65		
CL1662F	201.00	CL2030RME	112.00	CL2284T	49.00	CL2820H	180.00	CL5223R	3.25		
CL1662H	208.00	CL2036N	39.00	CL2288F	56.00	CL2820L	110.00	CL5223T	3.50		
CL1662R	186.00	CL2036P	156.00	CL2288H	61.00	CL2820M	154.00	CL5415H	134.00		
CL1662T	193.00	CL2036R	69.00	CL2288NK	13.00	CL2820NK	71.00	CL5415K	63.50		
CL1917H	620.00	CL2056Y	14.00	CL2288R	44.00	CL2820Q	133.00	CL5415L	134.00		
CL1941F	62.00	CL2057R	16.00	CL2288T	49.00	CL2820R	109.00	CL5415M	134.00		
CL1941H	68.00	CL2057Z	16.00	CL2289F	77.00	CL2840NK	76.00	CL5415N	46.50		
CL1941NK	13.00	CL2059R	24.00	CL2289H	89.00	CL2845NK	118.00	CL5415Q	134.00		
CL1941R	49.00	CL2059Z	20.00	CL2289NK	13.00	CL2885	11.00	CL5415R	90.50		
CL1941T	55.00	CL2060A	27.00	CL2289R	62.00	CL2886	13.00	CL5416H	219.00		
CL1955F	62.00	CL2060B	29.00	CL2289T	68.00	CL3005L	63.80	CL5416K	119.00		
CL1955H	68.00	CL2060C	30.00	CL2330F	56.00	CL3005NK	56.65	CL5416L	184.00		
CL1955NK	13.00	CL2060D	31.00	CL2330H	58.00	CL3005R	62.70	CL5416M	208.00		
CL1955R	49.00	CL2062B	29.00	CL2330K	49.00	CL3375F	76.00	CL5416N	99.50		
CL1955T	55.00	CL2062C	34.00	CL2330N	49.00	CL3375H	82.00	CL5416Q	196.00		
CL1957F	77.00	CL2062D	34.00	CL2330R	51.00	CL3375K	43.00	CL5416R	140.00		
CL1957H	89.00	CL2062H	41.00	CL2330T	54.00	CL3375N	41.00	CL6005LQ	51.15		
CL1957NK	13.00	CL2154H	17.00	CL2395F	14.00	CL3375R	47.00	CL6005NK	44.00		
CL1957R	62.00	CL2154NR	14.00	CL2395H	15.00	CL3375T	53.00	CL6005R	50.05		
CL1957T	68.00	CL2155L	23.00	CL2395K	9.45	CL3376H	76.00	CL6105	259.00		
CL1961K	22.00	CL2155NK	18.00	CL2395N	8.25	CL3376K	37.00	CL6309LQ	7.65		
CL1961N	21.00	CL2155R	21.00	CL2395R	10.50	CL3376NR	37.00	CL6309MH	8.80		
CL1971NK	13.00	CL2175L	11.00	CL2395T	11.75	CL3376T	52.00	CL6309NK	5.25		
CL1987A	36.00	CL2175NK	6.20	CL2395V	21.00	CL3505LQ	97.90	CL6309R	6.20		
CL1987R	37.00	CL2175MH	16.00	CL2400F	23.00	CL3505MH	99.00	CL6311LQ	10.50		
CL1987Y	34.00	CL2175Q	11.00	CL2400H	26.00	CL3505NK	90.75	CL6311MH	12.10		
CL1987Z	35.00	CL2175R	7.65	CL2400K	14.15	CL3505R	96.80	CL6311NK	8.25		
CL1989A	46.00	CL2180L	15.00	CL2400N	13.00	CL3506LQ	101.20	CL6311R	9.25		
CL1989B	48.00	CL2180MH	22.00	CL2400R	16.00	CL3506MH	102.30	CL6506LQ	78.10		
CL1989C	50.00	CL2180NK	8.85	CL2400T	20.00	CL3506NK	94.05	CL6506NK	70.95		
CL1989D	53.00	CL2180Q	16.00	CL2400V	34.00	CL3506R	100.10	CL6506R	77.00		
CL1990B	48.00	CL2180R	8.85	CL2408NK	3.50	CL3507MH	116.60	CL8117C	2443.00		
CL1990C	54.00	CL2180V	49.00	CL2415A	243.00	CL3507Q	115.50	CL8117D	2497.00		
CL1990D	60.00	CL2185FH	26.00	CL2415R	270.00	CL3509MH	150.70	CL8117E	2551.00		
CL1990E	66.00	CL2185NK	21.00	CL2415Y	205.00	CL4006L	46.20	CL8145B	1797.00		
CL1991C	55.00	CL2185RT	23.00	CL2415Z	224.00	CL4006NK	39.05	CL8145C	1844.00		

CS NUMBERS	
CS100	490.00
CS3256B	18.00
CS4910B	40.00
CS4910D	40.00
CS4911A	42.50
CS4911C	42.50
CS4912C	44.50
CS4912D	44.50
CS4913E	47.50
CS4913F	47.50
CS4913S	47.50
CS4914C	69.00
CS4914D	69.00
CS4914E	69.00
CS4915Q	80.00
CS4916R	80.00
CS4920B	69.50
CS4920D	69.50
CS4921A	75.50
CS4921C	75.50
CS4922Y	93.50
CS4922Z	93.50
CS4924C	69.00
CS4924D	69.00
CS4924E	69.00
CS4924F	69.00
CS4924S	69.00
CS4930	96.00
CS4931	99.00
CS9600	147.00
CS9630	6.40
CS9631	6.40

**SEND ORDERS TO**  
**GILBERT & RICHARDS, Inc.**  
**2558 WHITNEY AVENUE**  
**HAMDEN 14, CONN.**