

Keep Your Lathe In Trim

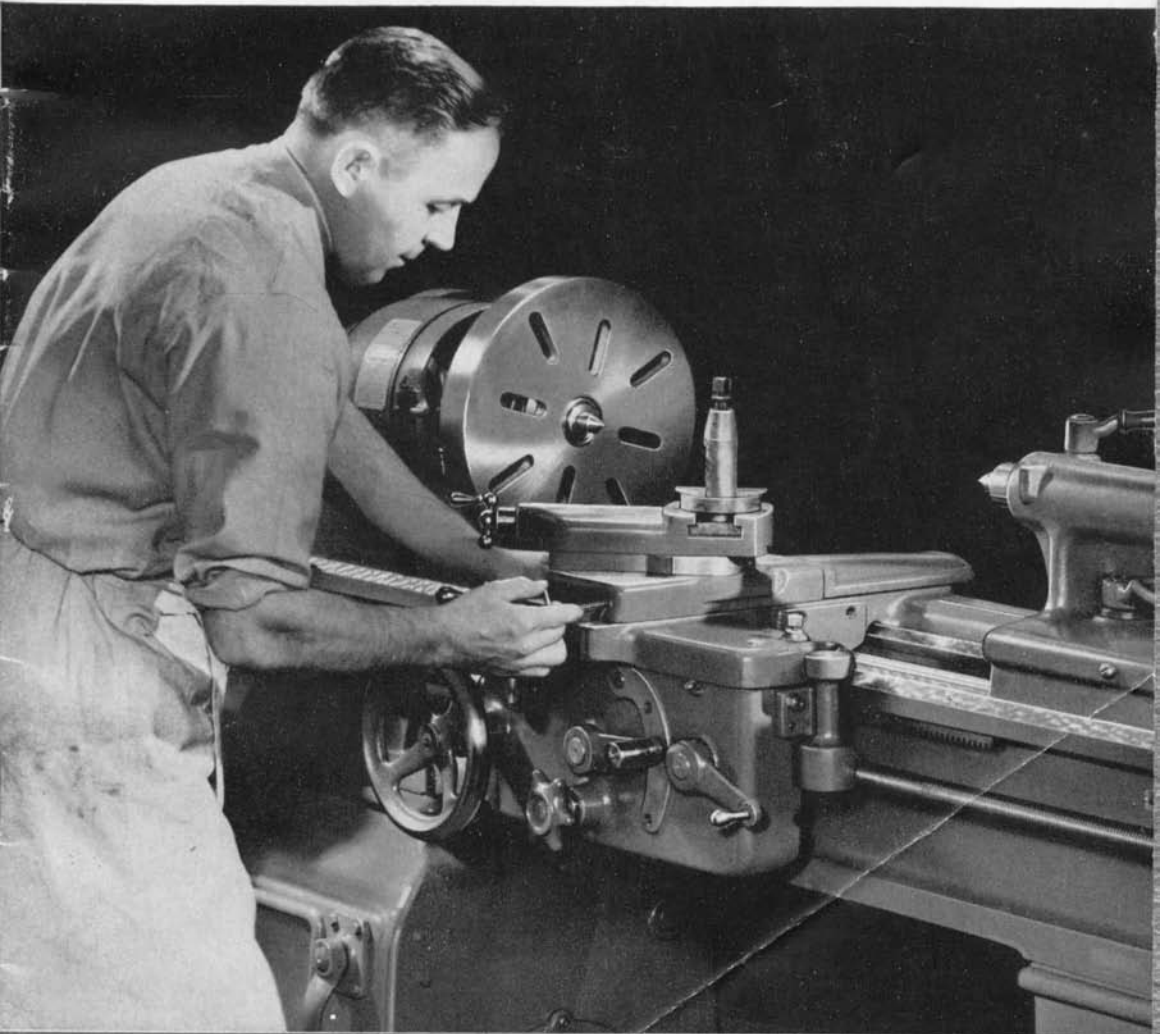

SOUTH BEND LATHE WORKS

SOUTH BEND 22, INDIANA, U. S. A.

HOW TO GET THE MOST OUT OF YOUR LATHES

A Series of Bulletins on the Care and Operation of Metal Working Lathes

These bulletins are supplied in any reasonable quantity without charge to shop instructors and others who are interested in the care and operation of the lathe.

Bulletin H-1—"Keep Your Lathe Clean". Shows how protecting the lathe from abrasive dirt will increase production, reduce scrap, and lengthen the life of the lathe.

Bulletin H-2—"Oiling the Lathe". Explains the importance of adequate lubrication.

Bulletin H-3—"The Installation and Leveling of the Lathe". Gives detailed information on the correct installation and leveling of the lathe for precision work.

Bulletin H-4—"Keep Your Lathe in Trim". Tells how to make all necessary adjustments, check power supply, protect lathe from abuse, and keep lathe in best operating condition.

Keep Your Lathe In Trim

Prepared by

Technical Service Department

South Bend Lathe Works

Bulletin H-4

Fourth reprint 1946, Copyright 1942

All Rights Reserved

SOUTH BEND LATHE WORKS

South Bend 22, Indiana, U. S. A.



Fig. 1. Given the proper care, a good lathe will retain its accuracy indefinitely. This old South Bend lathe has been in continuous service for more than 25 years and still does precision work.

KEEP YOUR LATHE IN TRIM

Importance of Adjustment

The old proverb, "An ounce of prevention is worth a pound of cure", is just as applicable today as when first expressed by some long forgotten sage. Lathes and other modern precision tools must be "kept in trim" if they are to give the long, trouble-free service that is expected of them.

Although the adjustments required to "keep the lathe in trim" are comparatively simple and few, they are important and should not be neglected. And even though the lathe is rigidly constructed and will stand a certain amount of rough handling, it should be protected from unnecessary abuse.

Motor and Power Supply

Maximum efficiency, as well as maximum production, depends on the continuous transmission of adequate power to the lathe spindle. Any loss of power through improper adjustment of the motor or variation of electric power supply will reduce the effective cutting power of the lathe. It is therefore necessary to check both the motor and the electric power supply when the lathe is installed.

The motor should be the size, type, and speed recommended by the lathe manufacturer. The ratings stamped on the nameplate of the motor should correspond with the electric current on which the motor is to operate. The voltage should be checked at the motor occasionally (see Fig. 2, page 6) and should not vary more than ten percent from the nameplate voltage. Lead-in wires should have sufficient capacity to maintain the required line voltage. If for any reason the line voltage drops more than ten percent below the rating for which the motor is constructed, the motor will not deliver full power.



Fig. 2. Checking the line voltage at the motor.

The best practice is to bring the electric power line up through the floor close to the lathe, as shown in Fig. 3. All electrical connections should be properly made, either twisted together and soldered, or bolted tightly enough that they will not be loosened by vibration. All joints should of course be first wrapped with rubber tape, then with friction tape. Electrical work must always conform with established laws, ordinances, and codes.

The motor should be inspected frequently and kept in good operating condition. It should be well protected from dirt and chips, but must have adequate ventilation to prevent overheating. The commutator and brushes should be kept in good condition and properly adjusted. The motor should be cleaned and lubricated regularly.

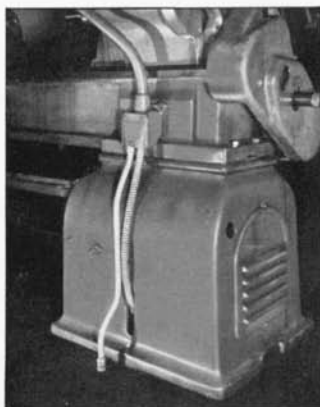

Fig. 3. Electric power line brought through floor close to lathe.

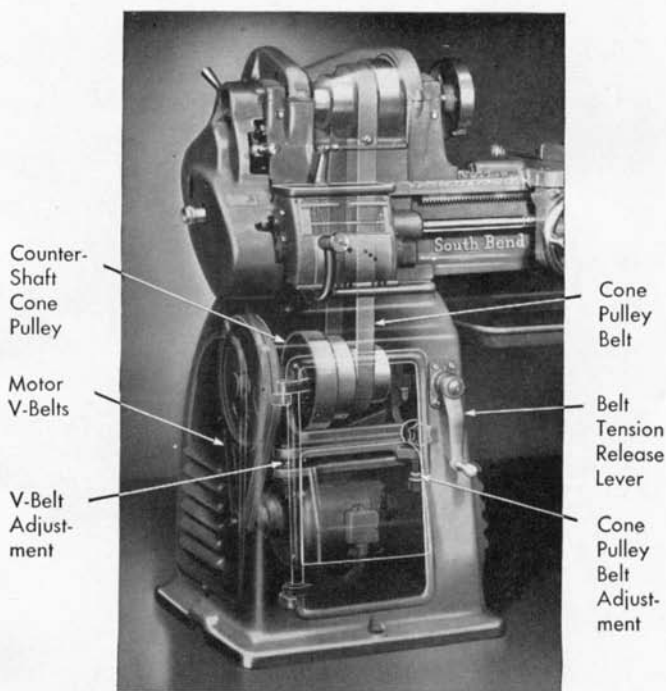

Fig. 4. Phantom view of underneath motor drive mechanism.

Belt Tension Adjustment

To transmit power from the motor to the lathe spindle efficiently, all belts must be properly adjusted. If the belts are too loose they will slip, and if they are too tight they will cause loss of power through friction, and may also cause excessive wear on bearings. The belts should be just tight enough to transmit the required power without slipping.

Precision belt tension adjustments provided on South Bend Lathes make it easy to keep the motor V-belts and flat cone pulley belt properly adjusted. The adjustments vary, depending on the size and type of lathe, as shown in Figs. 4, 5, 8, and 9.

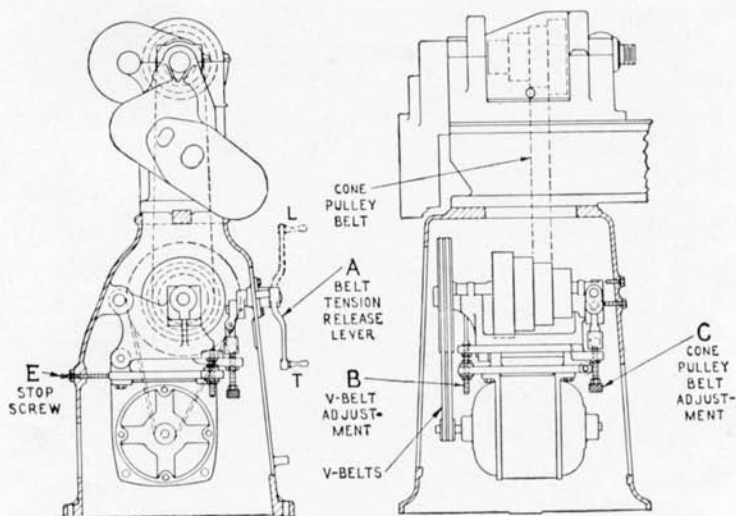

Fig. 5. Cross section drawing of 13-inch underneath motor drive, showing adjustments for motor V-belts and cone pulley belt.

Motor V-Belt Adjustment

The adjustment of the V-belts which transmit power from the motor to the countershaft can be tested by pressing the hand on the belts between the pulleys. It should be possible to depress the belts about 1" at a point midway between the pulleys. The V-belts should be stretched tight enough to feel alive when tapped with the finger tips, not dead and lifeless.

On 10" and Larger Lathes the V-belts are adjusted by turning the adjusting nuts on screw "B", Figs. 5, 7, and 8. Turning these nuts to the left tightens the belt. If the lathe has a stop screw ("E", Figs. 5 and 6) this screw must be unscrewed several revolutions before adjusting the V-belt tension. After the correct belt tension is secured, stop screw "E" should be readjusted so that it supports the weight of the motor drive mechanism and eliminates play when the belt tension release lever "A", Fig. 5, is in the lower position "T". Late models of lathes have a counterbalance spring which eliminates the necessity of the stop screw.



Fig. 6. If lathe is equipped with stop screw "E", it must be unscrewed before adjusting belts.

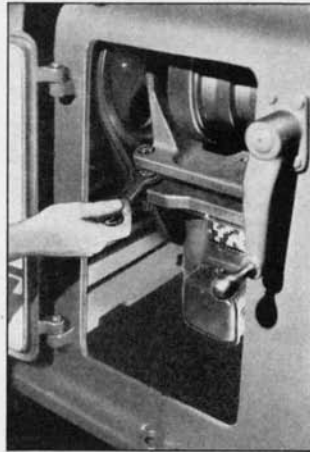

Fig. 7. Adjusting V-belt tension on 13" lathe.

On the 9" Lathes, the V-belt tension is adjusted by loosening the bolts in the motor base "O", Fig. 9, and sliding the motor.

Do not allow oil to come in contact with rubber V-belts. Oil takes the life out of rubber belts and causes them to slip. When V-belts are replaced a complete matched set of new belts should be installed. Unless all belts in the set are exactly the same length they will not operate efficiently.

Cone Pulley Belt Adjustment

The adjustment of the cone pulley belt tension can be tested by pressing on the belt between the pulleys. It should be possible to depress the belt about $\frac{1}{2}$ " at a point near the head-stock cone pulley. The belt should be just tight enough to transmit the required power without slipping.

On 10" and Larger Lathes the cone pulley belt tension is adjusted by turning knurled knob "C", Figs. 5, 8, and 10. This adjustment should be made with the belt tension release lever "A" in the position "T". Turning this knob to the right tightens the belt. If the lathe has a stop screw ("E", Figs. 5 and 6) this

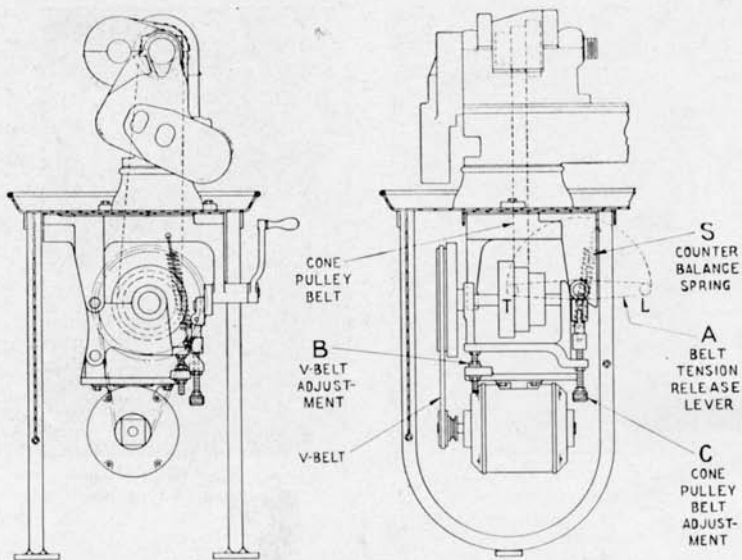

Fig. 8. Belt tension adjustments on 10" Bench Lathes.

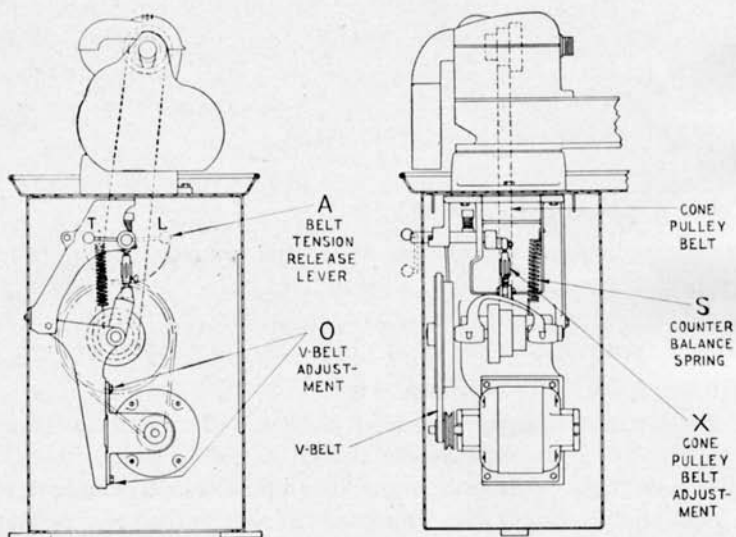

Fig. 9. Belt tension adjustments on 9" Lathes.

screw must be unscrewed several revolutions before adjusting the cone pulley belt tension.

After adjusting the cone pulley belt, stop screw "E" must be readjusted so that it supports the weight of the motor drive mechanism and eliminates play when the belt tension release lever "A" is in position "T". Stop screw "E" is not used on the late models of lathes.

On 9" Lathes the cone pulley belt tension is adjusted by turning turnbuckle "X", Fig. 9. This adjustment should be made with the belt tension release lever "A" in position "T".

Good quality leather belts are best for lathe cone pulleys. They have sufficient elasticity to transmit power efficiently and they give good service. No belt dressing is required if the belts are kept clean and dry. Machine oil will cause belts to slip. A little neatsfoot oil may be used occasionally to keep the belt pliable.

Shortening the Cone Pulley Belt

If the cone pulley belt should stretch to the extent that it cannot be tightened by further adjustment, it should be shortened by cutting out a short piece and re-splicing.

The belt should first be separated at the original splice and removed from the lathe. Place belt tension lever "A" in position "T", Figs. 5, 8, and 9, and turn the belt tension adjustment knob until lower cone pulley is in the extreme upper position. Leaving the belt tension lever in position "T", measure over two corresponding steps of the upper and lower cone pulleys with a steel tape to determine the exact length of belt required. Before cutting the belt to length, decide on the method of splicing. See Figs. 13, 14, and 15.



Fig. 10. Adjusting cone pulley belt tension.

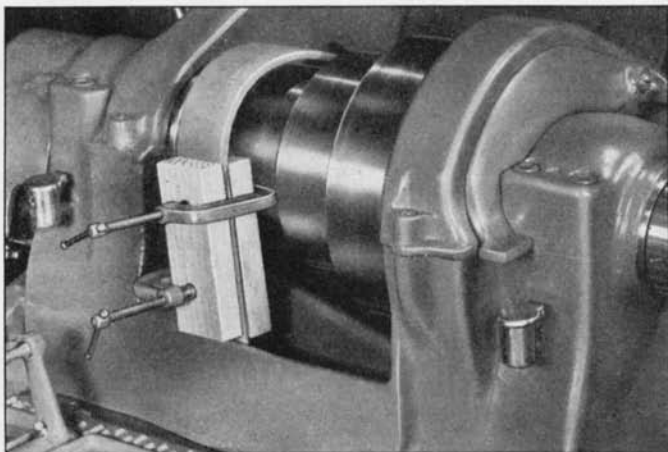

Fig. 11. When properly made, a glued belt splice is very durable and runs over pulleys smoothly.

Splicing Leather Belts

Leather belts may be spliced by gluing, lacing, or with belt hooks. If a glued splice is to be used, be sure to allow sufficient length of belt for lapping the ends together when cutting the belt to length.

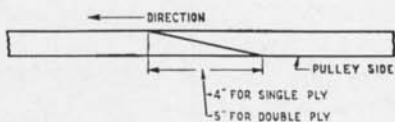

Fig. 13. Glued Splice for Leather Belt.

Glued Belt Splice

A glued splice is preferred by some because, when properly made, it is very durable and will run over the cone pulleys more smoothly than a laced or hooked splice.

To make a good glued splice, the ends of the belt must be tapered uniformly, as shown in Fig. 13. Trim the ends square (using a small try-square) and to the length required, plus a sufficient length for the ends to lap at the splice. Taper the ends smoothly with a belt shave, small plane, or sharp knife.

When the belt is cut to the required length, replace on lathe cone pulleys and cement the ends together. Any good belt

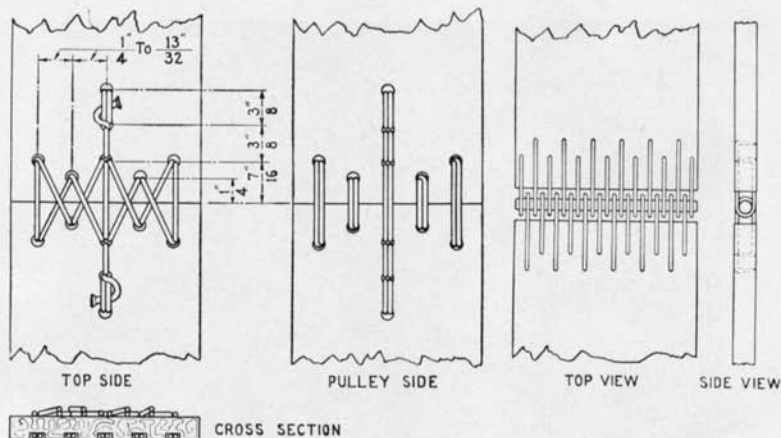

Fig. 14. Laced belt splice.

Fig. 15. Hooked belt splice.

cement can be used, providing the instructions supplied with the cement are followed carefully. Waterproof belt cement is recommended. Clamp the joint securely together with C clamps, using small board on each side of the belt as shown in Fig. 11. A couple of small nails driven through the boards and belt ends will keep the splice from slipping. Allow the cement to dry thoroughly before removing the clamps.

Laced Belt Splice

Leather belts may be joined by lacing with gut or rawhide thongs as shown in Fig. 14. Trim the ends of the belt square (using a steel try-square) and to the length required. Punch or drill holes just large enough for the lace. Punch the holes at the exact center of the belt first, then punch additional holes equally spaced, $\frac{1}{4}$ " to $\frac{13}{32}$ " apart, on either side of the center holes. The number of holes required will depend on the width of the belt, wider belts of course requiring more holes.

The holes must be evenly spaced and each hole must be directly opposite the corresponding hole in the other end of the belt. If a round gut lace is used, cut straight grooves on the pulley side $\frac{1}{8}$ in. wide, $\frac{1}{16}$ in. deep from each hole to the end of the belt. This will prevent the lace from cutting and allow the belt to run smoothly over the pulleys.



Fig. 16. Adjusting back-gear eccentric shaft tension bushing.

Place the belt over the lathe cone pulleys and bring the ends of the belt together. Push the two ends of the lace down through the two opposing center holes, starting from the outer or top side of the belt. Pull the ends of the lace through evenly, then bring them up through the opposite center holes. Be careful not to kink the lacing. Work each end out toward the opposite edges of the belt, then back to the center. Do not cross the lacing on the grooved or pulley side of the belt. Fasten the ends as shown in Fig. 14 and burn the ends close with a lighted match to prevent them from pulling out.

Hooked Belt Splice

There are a number of good belt hooks on the market that can be used for fastening belt ends together. Belt hooks may be used for belts that are not shifted while they are in operation, but should never be used on belts that are shifted while the belt is running. See Fig. 15.

Back-Gear Tension

The back-gears on the lathe headstock are held in position by a friction bushing mounted in the back-gear lug next to the large spindle bearing. The tension on the friction bushing is adjusted by turning the set screw as shown in Fig. 16. This

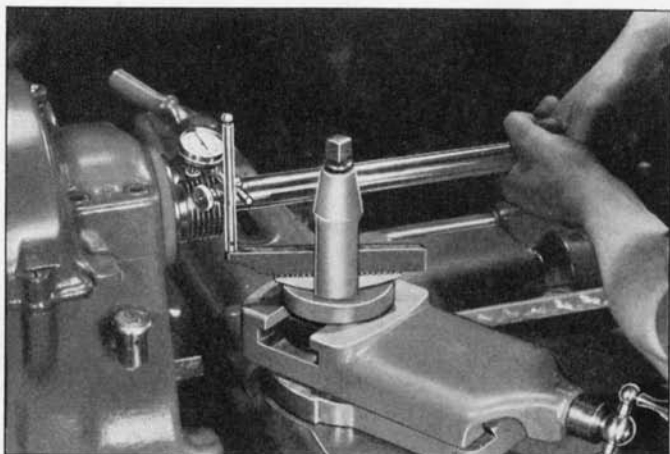

Fig. 17. Testing large spindle bearing for clearance.

set screw should be tight enough to hold the gears in mesh on heavy cuts, but should not be so tight that the back-gear lever is hard to operate.

Spindle Bearings

The headstock spindle bearings on South Bend Lathes are carefully fitted at the factory and if properly lubricated should not require adjustment. The bearings are so constructed that there is practically no wear so long as they are supplied with oil.

The spindle bearings should not be adjusted unless the need for adjustment is definitely established. Do not assume that the the bearings are too tight because they become hot. The heating may be caused by lack of oil or the wrong grade of oil. Chatter is no indication that the spindle bearings are loose. In fact, chatter is sometimes caused by bearings being too tight.

If the headstock spindle bearings should appear to require adjustment, tests should be made to establish the amount of adjustment required before the bearing caps are loosened. Do not remove the bearing caps or loosen the cap screws unless adjustment is definitely required. The adjustment of the spindle bearings is critical, and much harm can be done by incorrect adjustment.

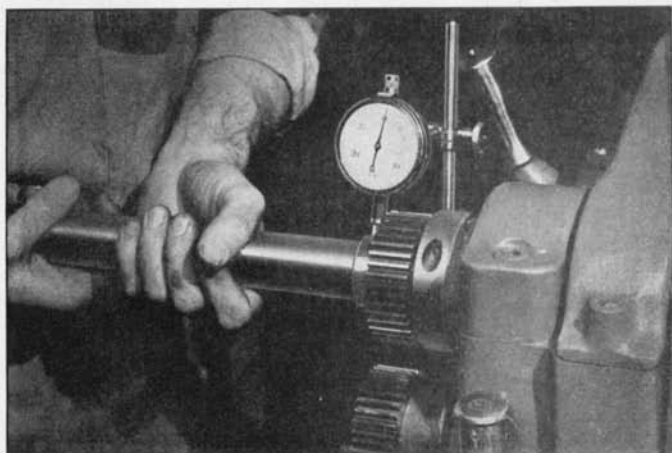

Fig. 18. Testing small spindle bearing for clearance.

Before testing the spindle bearings, release the tension on the cone pulley belt. Make sure that the lathe is properly leveled and bolted to the floor, see Bulletin H-3. Check the bolts which hold the headstock to the lathe bed and tighten them if they are loose. Also examine the headstock bearing cap bolts and tighten if necessary.

Testing Bearing Adjustment

To test the large spindle bearing, place a test bar about 12" long in the taper of the spindle and mount a dial indicator in the tool post in such a way that a reading can be taken on the outside diameter of the spindle nose—*not on the test bar*. See Fig. 17.

Grasp the test bar in the hand and lift on the outer end. The dial indicator should show a movement of .001" to .002" if the bearings are in good condition and properly adjusted. Less than .001" movement will indicate very little clearance for oil film, which may cause the lathe to chatter, or may cause the bearings to heat and become scored. If more than .002" spindle movement is indicated, it may be necessary to take up the bearing.

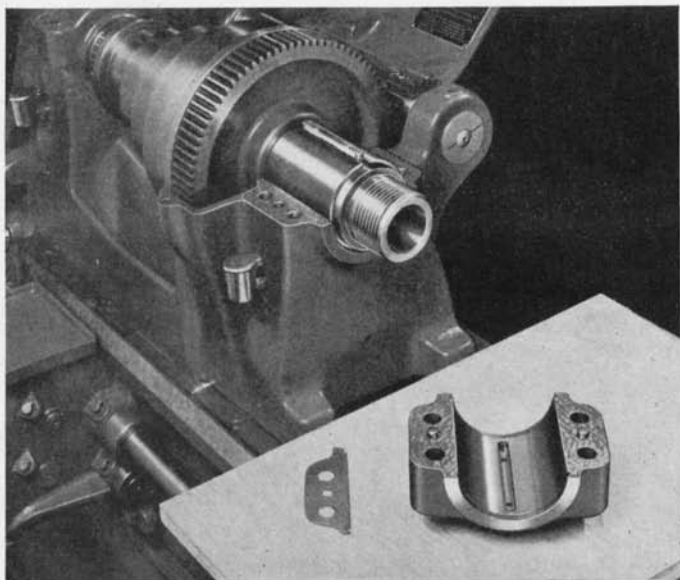

Fig. 19. Sleeve type headstock spindle bearing with dovetail key lock.

A similar test can be made on the small spindle bearing, clamping the dial indicator to the back gear lug and taking the reading on the outside diameter of the spindle at the small end. See Fig. 18.

Adjusting Headstock Spindle Bearings

Do not adjust headstock spindle bearings unless they have been tested as outlined on pages 15 and 16, and prove to need adjustment. Before starting to take up the bearings read these instructions through to page 20.

Laminated shims are provided for adjusting the spindle bearings on all sizes of South Bend Lathes. Each lamination removed will take up the bearing about .002". In addition to the laminated shims, thin shims .001" thick are included on 10" and larger lathes having sleeve type bearings.

The correct procedure for taking up the sleeve type bearings now used on 10" and larger lathes is shown in a metal plate attached to the lathe headstock. (See Fig. 20.) Each operation must be performed in sequence as outlined, otherwise the bearing may be damaged.

The integral type bearings used on some South Bend Lathes are adjusted in the same way, but there is less difficulty in re-

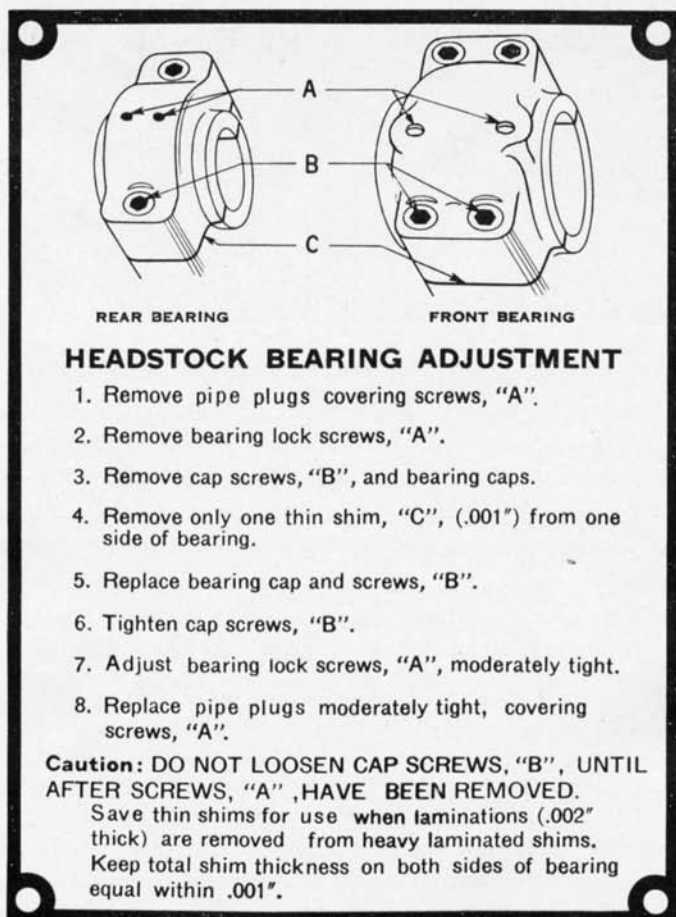

HEADSTOCK BEARING ADJUSTMENT

1. Remove pipe plugs covering screws, "A".
2. Remove bearing lock screws, "A".
3. Remove cap screws, "B", and bearing caps.
4. Remove only one thin shim, "C", (.001") from one side of bearing.
5. Replace bearing cap and screws, "B".
6. Tighten cap screws, "B".
7. Adjust bearing lock screws, "A", moderately tight.
8. Replace pipe plugs moderately tight, covering screws, "A".

Caution: DO NOT LOOSEN CAP SCREWS, "B", UNTIL AFTER SCREWS, "A", HAVE BEEN REMOVED.

Save thin shims for use when laminations (.002" thick) are removed from heavy laminated shims. Keep total shim thickness on both sides of bearing equal within .001".

Fig. 20. Reproduction of metal plate showing procedure for adjusting sleeve type spindle bearings.

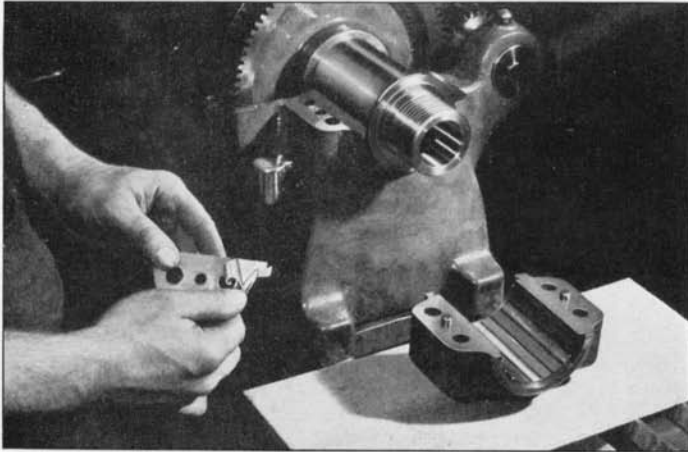

Fig. 21. Removing one lamination from shim to take up headstock spindle bearing.

moving the headstock cap. It is only necessary to remove the bearing cap hold down bolts before lifting the cap, as these bearings do not have the bearing lock. See Fig. 21.

Bearings for 9-inch lathes that do not have removable bearing caps are taken up by removing the bearing cap screw, taking out the shim, and peeling off one lamination.

Extreme care is required when the headstock bearing caps are removed. Before removing the caps, clean the headstock thoroughly, first with a brush, then with a clean cloth. Remove all dirt and chips that may have accumulated around the bearing. Laboratory cleanliness is essential. Do not allow the smallest particle of dirt, dust, chips or other foreign matter to get into the bearing or between the bearing cap and the headstock.

When taking up bearings on lathes having removable bearing caps, it is very important that the total thickness of shims be kept equal within .001" on both sides of the bearing. Otherwise the bearing cap will not be pulled down evenly and may be sprung out of shape. This, of course, does not apply to lathes that do not have removable bearing caps. Care should be taken to keep the shims in order so they can be replaced on the same side of the bearing, and the same side up as originally installed.

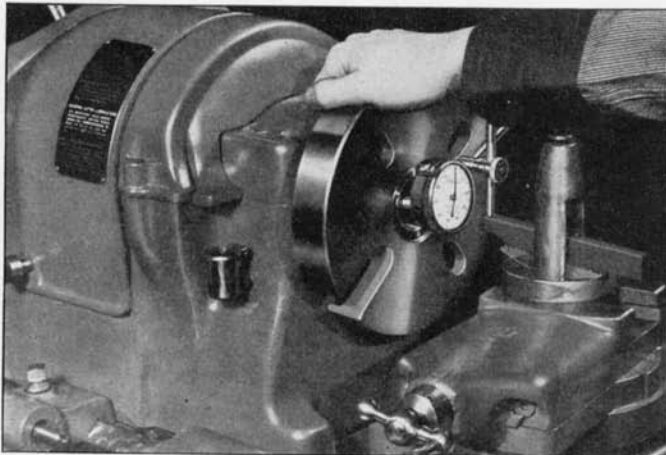

Fig. 22. Testing headstock spindle for end play.

Remove only *one* lamination of shim stock from each shim. See Fig. 21. Remove burrs on shims that may have been caused by peeling of the lamination, wipe shims clean, and replace the shims and bearing cap immediately. Tighten the cap bolts carefully, drawing them down with a uniform tension.

After tightening the bearing cap bolts, test the clearance for oil film as described on page 16. If there is less than .001" clearance, remove the bearing cap and insert a .001" shim on each side. Tighten the bolts and test again.

When the clearance is correct (.001" to .002"), oil the spindle bearings and start the lathe at a moderate speed. Feel the spindle bearings every few minutes. If they become uncomfortably hot to the hand, stop the lathe at once and readjust the shims.

Spindle Take-up Nut

The spindle take-up nut is threaded onto the small end of the spindle for adjusting the end play. A dial indicator mounted in the tool post, as shown in Fig. 22, can be used for testing the end play of the spindle. Notice that the indicator button rests on the end of the spindle, not on the face plate. If a movement of about .001" is indicated when the spindle is moved endwise

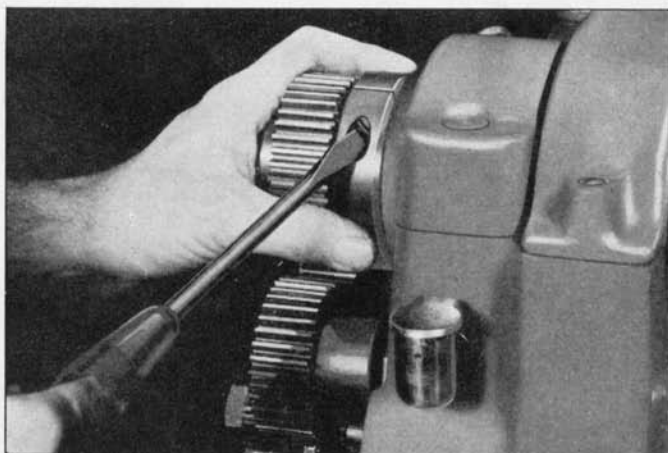

Fig. 23. Adjusting headstock spindle take-up nut.

in the bearings, the spindle take-up nut is properly adjusted. Less than .001" clearance is insufficient. Adjustment may be required if there is more than .002" movement.

To adjust the spindle take-up nut, it is first necessary to remove the gear guard on the left end of the lathe. The take-up nut binding screw may then be loosened as shown in Fig. 23, and the take-up nut adjusted. When the correct adjustment has been made, the binding screw must be tightened and the end gear guard replaced.

Dovetail Gibs

All dovetails on South Bend Lathes are equipped with straight gibs or tapered gibs which provide adjustment for wear. These gibs should be tight enough to eliminate play but should not be so tight that they bind and make the dovetails hard to operate. The best way to make the adjustment is to tighten the gib until the slide is too tight, then loosen the gib until the slide works freely.

Straight gibs are adjusted by turning the set screws which bear against them, as shown in Fig. 24. These screws should have a uniform tension.



Fig. 24. Adjusting straight dovetail gib.

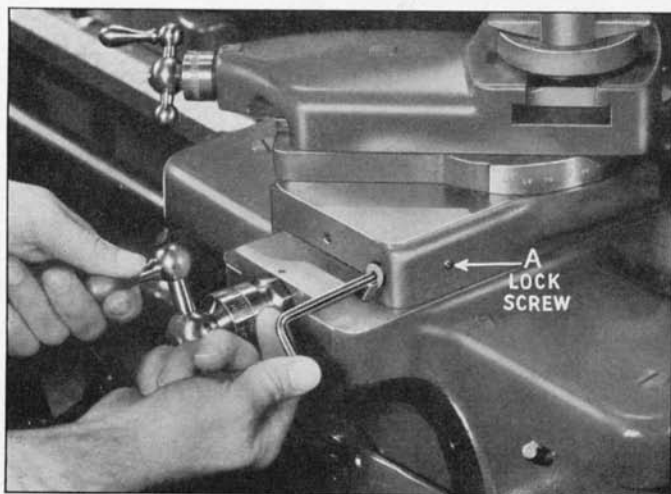

Fig. 25. Adjusting tapered dovetail gib.

Tapered gibs are adjusted by turning the gib adjusting screw as shown in Fig. 25. Before making this adjustment, the lock screw "A", Fig. 25, must be unscrewed about one revolution. The lock screw should of course be tightened after the gib has been properly adjusted.

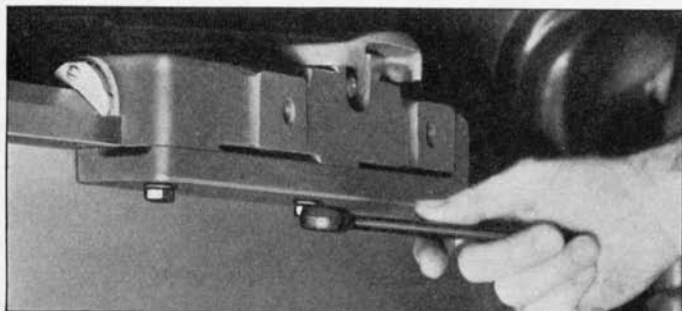

Fig. 26. Adjusting saddle hold-down gib.

Saddle Gib

The purpose of the saddle hold-down gib is to hold the back of the saddle down against the lathe bed. This gib should be tight enough to prevent the back of the saddle from lifting, but should not be tight enough to bind and make the carriage hard to move along the lathe bed by turning the apron handwheel.

The saddle gib is adjusted by turning the cap screws which hold it to the saddle. See Fig. 26. The adjustment can be tested by turning the carriage handwheel as the adjusting screws are tightened. Spring washers between the screw heads and the gib prevent the screws from working loose.

Keep Bolts and Screws Tight

All bolts and screws should be examined occasionally and any that work loose should be tightened. Use a good screwdriver or wrench and avoid damaging bolt heads and screws by letting the wrench or screwdriver slip. The screwdriver point should be ground square across the end and to fit the screw slot. Never grind a screwdriver to a chisel shaped point which will cause it to slip and damage the screw head. See Fig. 27.

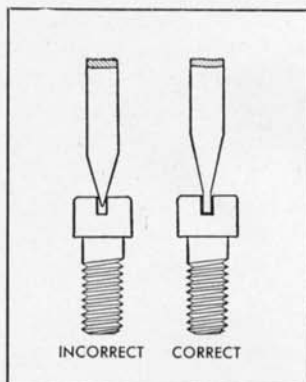

Fig. 27. Correct and incorrect methods of grinding screwdriver point.

Graduated Collars

The graduated collars on the cross-feed screw and the compound rest screw may be set at zero or any other graduation whenever desired. This is accomplished by loosening the lock screw as shown in Fig. 28, turning the graduated collar to the desired position, then tightening the lock screw. Some lathes have an improved graduated collar with a friction device which eliminates the necessity of using a set screw to lock the collar.

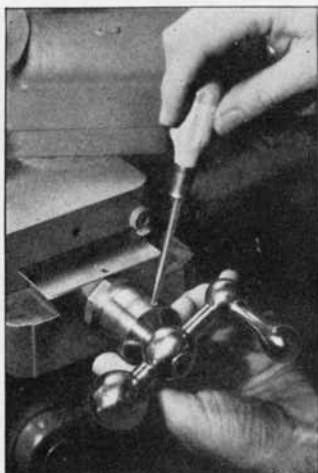

Fig. 28. Setting graduated collar on cross-feed screw.

Tailstock Top Set-Over

The tailstock top set-over screws "G" and "F", Figs. 29 and 30, are provided for aligning the tailstock center with the headstock center and for offsetting the tailstock center when it is desired to machine tapers between centers. It is sometimes necessary to adjust the tailstock top set-over when the position of the tailstock is changed for a different length of work. This is especially true of old lathes which may have worn spots or burrs on the bed ways.

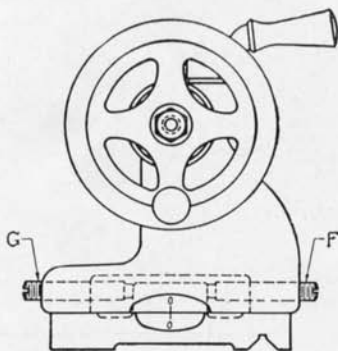

Fig. 29. Tailstock top set on center.

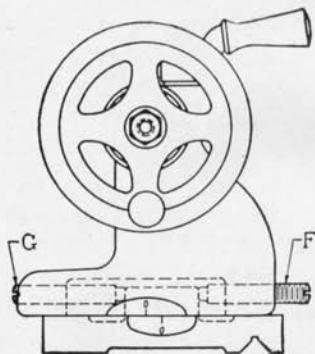

Fig. 30. Tailstock top set off center.



Fig. 31. Testing alignment of centers.

A good method of testing for the alignment of the lathe centers is shown in Fig. 31. A shaft about $1\frac{1}{2}$ " in diameter and 14" long is mounted between centers and two collars are turned about 10" apart. The collars are finished with a fine cut without changing the adjustment of the cutting tool. The collars are then carefully measured with micrometers, and if they are exactly the same diameter the centers are in perfect alignment. If the collars are not the same diameter, the alignment of centers is not correct and the tailstock top should be adjusted.

The tailstock clamp bolt nut must be loosened before the tailstock top alignment can be adjusted. The tailstock top alignment is adjusted by releasing one of the set-over adjusting screws and tightening the opposite screw, as shown in Fig. 32. After adjusting the tailstock set-over another test cut should be taken, and the collars measured. This operation should be continued until the desired degree of accuracy is obtained.

There are witness marks on the end of the tailstock to show the relative position of the tailstock top and bottom. See Figs. 29, 30, and 32. For fine, accurate work, these marks should not be depended upon, but the alignment test should be made as described above to be sure that the centers are in line.

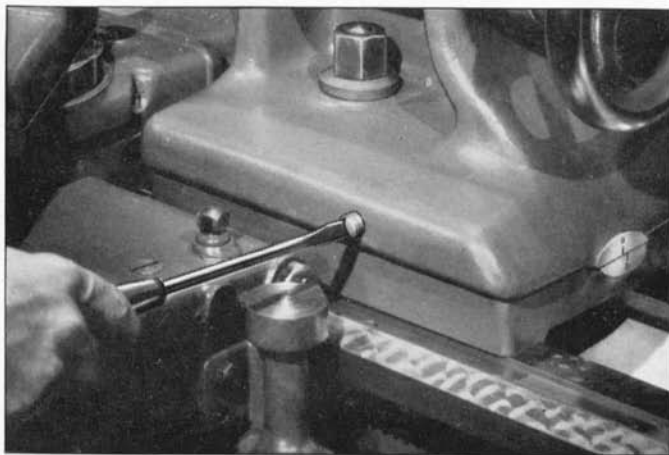

Fig. 32. Adjusting tailstock set-over screws to align centers.

Measuring Tailstock Set-Over

To measure the approximate set-over of the tailstock center, place a scale having graduations on both edges between the two centers, as shown in Fig. 33, or measure the distance between the witness marks on the end of the tailstock as shown in Fig. 30. These measurements are convenient for making preliminary adjustments but should not be depended upon for accurate work.

A more accurate method for setting over the tailstock top is shown in Fig. 34. Before moving the tailstock top, tighten the tailstock spindle binding lever and place a tool holder in the tool post with the blunt end toward the tailstock spindle. Hold a feeler gauge or slip of paper between the tool holder and tailstock spindle. Carefully bring the end of the tool holder against the feeler gauge until it touches the tailstock spindle and note the reading on the cross-feed screw graduated collar.

Watching the graduations on the cross-feed screw collar,

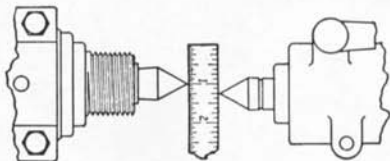

Fig. 33. Measuring tailstock top set-over with scale.

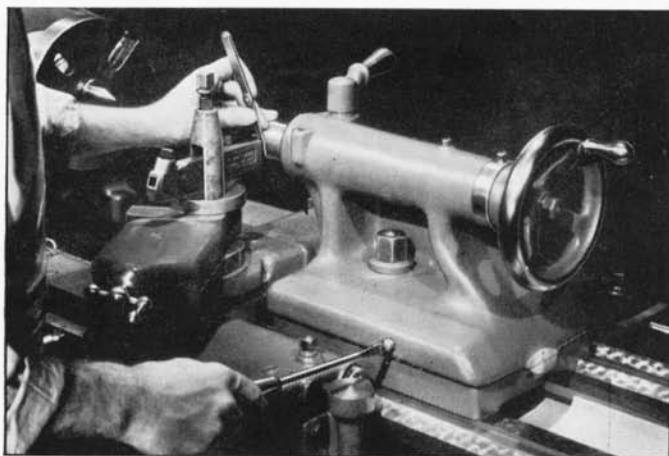

Fig. 34. Using a feeler gauge and the cross-feed screw graduations to measure the tailstock top set-over for taper turning.

turn the cross-feed screw out slightly more than the desired set-over, then turn back to the exact thousandth desired. This will take up the lost motion in the cross-feed screw and place the end of the tool holder at the exact point required to measure the tailstock set-over.

Now turn the tailstock top set-over screws until the feeler gauge indicates that the relative position of the tailstock spindle and tool holder are the same as before. The tailstock top set-over should be correct within $.001''$ if the adjustments have been made with reasonable care.

Don't Abuse the Lathe

The metal working lathe is a highly accurate precision tool. It is ruggedly constructed, and with the proper care will retain its accuracy through years of service. But just because the lathe is made of iron and steel is no reason to expect it to stand abuse.

Do not let chucks, tools, or work fall on the lathe bed. The smallest burr on the bed ways may prevent the tailstock or carriage from seating properly, throwing them out of alignment and causing the lathe to chatter.



Fig. 35. Use a board to support heavy chucks when mounting or removing from lathe spindle—do not let chucks fall on lathe bed.



Fig. 36. A tool tray is convenient and eliminates the temptation to lay tools on the lathe bed.

When mounting or removing heavy lathe chucks, use a board to support the chuck, as shown in Fig. 35. A tool tray similar to the one shown in Fig. 36 is very convenient and eliminates the temptation to lay tools on the lathe bed.



Fig. 37. Use a file card to clean chips out of files—never rap a file on the tailstock or other parts of lathe.

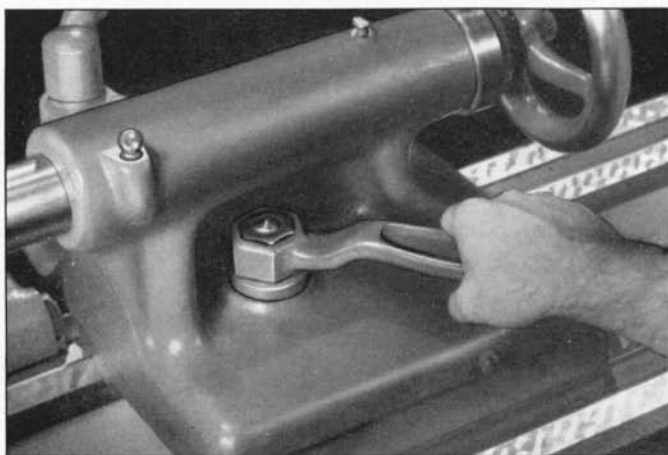

Fig. 38. Don't use a hammer or otherwise exert excessive force when tightening clamp bolts or binding screws.

Never rap a file on the tailstock or other parts of the lathe to knock out chips. This practice not only damages the lathe, but it is hard on the file. Use a file card to clean files. The use of the file card produces better results, takes less time, and harms neither the file nor the lathe. See Fig. 37.

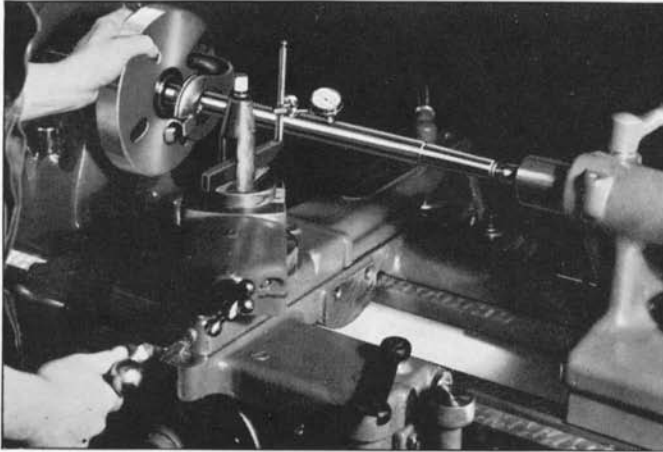

Fig. 39. Use the lathe only for testing bent shafts; use an anvil, a straightening press, or a vise for straightening.

Binding screws and clamp bolts should be tightened securely, but within reason. Do not use a hammer or otherwise exert excessive force on the wrench when tightening the tailstock clamp bolt, the tailstock spindle binding lever, the carriage lock screw, or the tool post screw. See Fig. 38.

The lathe bed should never be used as an anvil to straighten bent shafts or nails, or to drive a mandrel into a piece of work. Hammering on the lathe bed may cause it to change shape, thus destroying its accuracy. Use an anvil or a straightening press or a vise for straightening. Use an arbor press or a lead hammer for driving mandrels into the work.

It is all right to place a bent shaft between the lathe centers for testing to find out where it is bent, as shown in Fig. 39. But no attempt should be made to straighten shafts between centers. Straightening a shaft by prying or hammering on it when it is mounted between the lathe centers may impair the accuracy of the lathe.

Given the proper care, a good lathe should last a lifetime. Protect the lathe from abuse and it will retain its accuracy indefinitely. See Fig. 1.