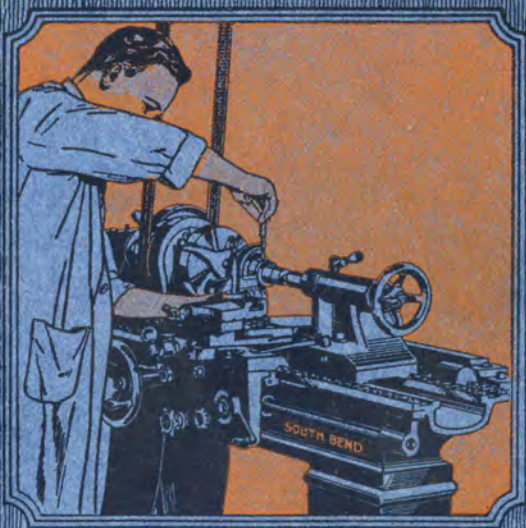


How to Run a Lathe

The Care and Operation of a Back
Geared Screw Cutting Lathe



WHEN interested in the purchase of a lathe write for a Catalog illustrating and describing the New and Improved line of Back Geared Screw Cutting Precision Lathes which are built in 96 sizes, types and patterns. This Catalog contains valuable data on lathes, tools and attachments and will be sent postpaid, no charge, to your address upon request.

How to Run a Lathe

Instructions on the Care and Operation of A Back Geared Screw Cutting Engine Lathe

For the Machinist Apprentice

29TH EDITION

Copyright, August, 1930
29th Printing
SOUTH BEND LATHE WORKS
J. J. O'BRIEN—M. W. O'BRIEN

Price 25 Cents Postpaid

Coin or Stamps of Any Country Accepted



Cable Address

"TWIN'S" SOUTH BEND, U. S. A.

CODES:

Western Union Five Letter Edition.
Western Union Universal Edition.

A. B. C. Fifth Edition Improved.
Bentley's, Lieber's Standard.

SOUTH BEND LATHE WORKS

435 E. Madison Street
SOUTH BEND, INDIANA, U. S. A.

Printed in U. S. A.

PREFACE

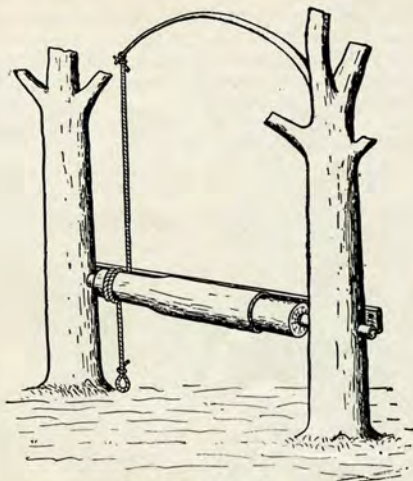
ONE of the great needs of industry today is well trained workmen: men who are trained to work with their hands and also to think about their work, diagnose troubles and suggest improvements. No man can hope to succeed in any line of work unless he is willing to study it and increase his own ability in it.

It is the purpose of this book to aid the beginner or apprentice in the machine shop and the student in the school shop, to secure a better understanding of the fundamentals of the operation of a modern Screw Cutting Engine Lathe. In illustrating and describing the fundamental operations of modern lathe practice we have made an effort to show only the best and most practical methods and have tried to avoid tricks and freak methods so that the beginner may learn how to do his work properly.

We are indebted to so many manufacturers, engineers, authors, educators, mechanics and friends for assistance in the preparation of this book, that it would be impossible to give them individual mention here. However, we wish to express our appreciation for the co-operation that has made this work possible.

SOUTH BEND LATHE WORKS.

August 1, 1930.



The Tree Lathe

HISTORY OF THE LATHE

The earliest lathe that we have record of was a tree lathe for turning wood, such as shown in the illustration above. A mechanic selected two trees with sufficient distance between them to take care of the job he had to do. He then fastened center pins in each tree and centered the wooden log on each end, placing it between centers. He attached a rope to a convenient limb overhead which would give sufficient spring. Then he coiled the other end of the rope around the work to be turned, and made a loop in the rope near the ground for the operator's foot. It required two men to operate the lathe; one to supply the required foot power to revolve the work and the other to operate the turning tools.

DEVELOPMENT OF THE SCREW CUTTING LATHE

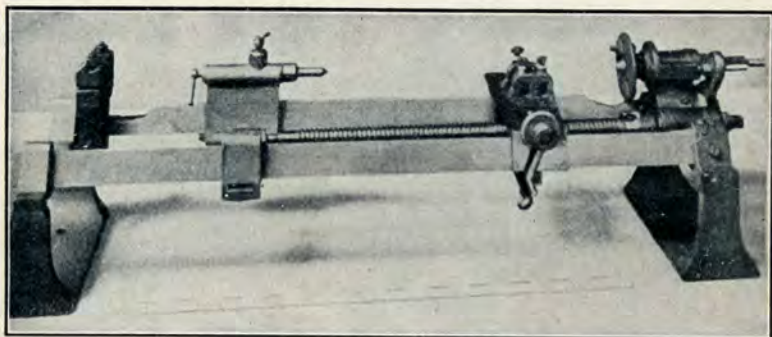
The early screw cutting lathes were operated by foot power. The invention of the steam engine made it possible to operate the primitive machines of that time by power, and the lathe was equipped with a countershaft and driven by engine power instead of foot power, hence the name Engine Lathe.

The screw cutting engine lathe is the oldest, the first developed and most important of all the machine tools and from which were developed all other machine tools. This lathe is sometimes called the Universal Tool. It was the lathe that made possible the building of the steamboat, the locomotive, the electric motor, the automobile and all kinds of machinery used in industry. Without the lathe our great industrial progress of the past century would be impossible.

The earliest screw cutting lathe that we have record of was built in France in about 1740. The name of the maker is not known. It was a small lathe, four or five inch swing, and was used principally for the making of small instruments, etc. It was fitted with a lead screw.

There was not much further development in lathes until 1797, when Henry Maudslay, an Englishman, designed and built a small screw cutting engine lathe. Through the courtesy of Mr. Joseph Wickham Roe,

author of "English and American Tool Builders," we herewith show an illustration of the Maudslay lathe referred to. This lathe, about a 10-inch swing, you will note is fitted with a Lead Screw, which is geared to the spindle. The slide rest or carriage is driven by the screw. When this lathe was first built it required a different lead screw for each variation of pitch; later, variation in pitch was obtained by change gears. In this lathe Maudslay gave us the fundamental principles of the screw cutting engine lathe which are still in use today.



Maudslay Lathe

FIRST LATHES BUILT IN UNITED STATES

There were a few lathes built in the United States between 1800 and 1830, the beds being made of wood, with iron ways. In 1836 Putman of Fitchburg, Massachusetts, built a small lathe which was fitted with Lead Screw. The spindle was driven by back gearing. In 1850 iron bed lathes were made in New Haven, Connecticut, and in 1853 Freeland, in New York City, built a lathe, estimated 20 in. x 12 ft., with iron bed, back geared head. The spindle was connected with the Lead Screw by change gears. There was no rack, the carriage was driven by the Lead Screw.

History does not give the pioneer machine tool manufacturers of New England and New York the credit that is due them. It was through their efforts, mechanical ability, and perseverance that the United States is today the greatest manufacturing country in the world. The early machine tools that these men designed and built made it possible for some of the earlier blacksmith shops of New England to start manufacturing in a small way. Between 1800 and 1850 many small factories appeared throughout New England, making such articles as plows, hoes, firearms, clocks, axes, hardware, and household utensils. As these industries prospered, mechanics designed and built special machines and mechanical devices in order to make the product more accurate and in a greater quantity. The development of the lathe and other machine tools from 1840 on was rapid.

AMERICAN MACHINE TOOLS MOST POPULAR

The Civil War in 1861-64 accelerated the development of machine tools in the United States to such an extent that in about 1880 American machine tools, as lathes, milling machines, planers, etc., led the world in design, accuracy, efficiency, production and reputation.

DISTINGUISHED INVENTORS AND MECHANICS

Eli Whitney



Born in Westboro, Mass. (1765-1825); in 1793 invented cotton gin which performs the work of 5,000 persons. Produced firearms by the interchangeable system of parts.

George Westinghouse



Born in New York (1846-1914); when but 15 invented a rotary engine; served in Union Army '63-'64; inventions include air brake and number of signalling devices. Founder of Westinghouse Electric Company.

(Photo Underwood)

Robert Fulton



Born in Little Britain, Pa. (1765-1825); invented steamboat, 1793; submarine torpedoes, 1797-1801; launched "Clermont" steamboat, 1807; built steam ferry boat, 1812; built first steam war vessel, 1814.

Orville Wright



Born in Dayton, Ohio (1871-....), and with brother Wilbur (1867-1912) won distinction by inventions and exploits in aviation. Began study of aeronautics in small bicycle repair shop in Dayton. In 1900 began experiments in aviation and developed the celebrated "Wright Biplane." (Photo Underwood)

Cyrus H. McCormick



Born in Walnut Grove, Va. (1809-1884); exhibited harvesting machine in 1851 at World's Fair in London, with practical results. Mr. McCormick's patents made him a millionaire.

Thomas Alva Edison



Born in Ohio (1847-...); printer's boy, telegraph operator. Invented quadruplex telegraph in 1864. Many inventions followed, including incandescent lighting system, dynamo and phonograph. Patented over 600 inventions.

(Photo Underwood)

Elias Howe



Born in Spencer, Mass. (1819-1867); machinist; patented sewing machine, 1846. Priority of patent contested until 1854, when favorable decision of courts brought him large royalties.

Guglielmo Marconi



Born near Bologna, Italy (1874-....). Italian electrician. First wireless station established near Cornwall, England. Successfully sent signals across Atlantic for first time in 1902.

(Photo Underwood)

Alexander Graham Bell



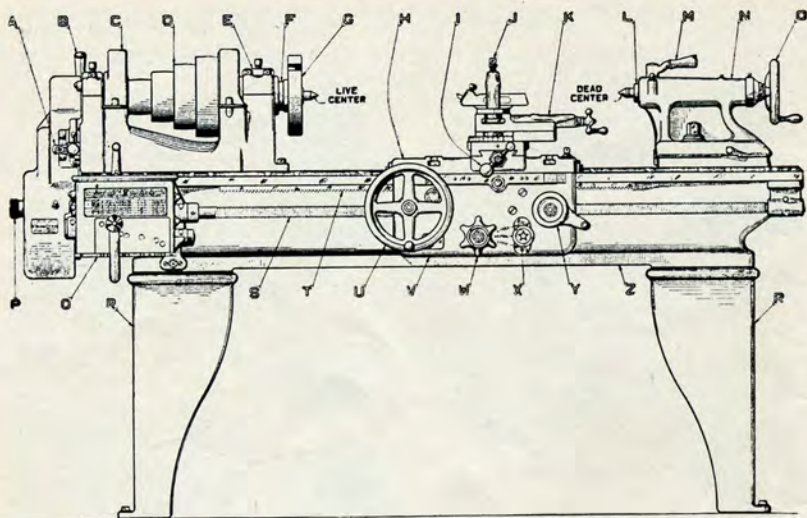
Born in Scotland (1847-1922); produced electric telephone, 1876. Author of many valuable scientific contributions. Telephone brought immense wealth to himself and associates.

Henry Ford



Born in Greenfield, Mich. (1863-....). In 1887 he became chief engineer for the Edison Illuminating Co. In 1903 organized the Ford Motor Co., which he developed into the largest automobile manufacturing plant in the world. A leader in development of commercial aviation.

(Photo Underwood)



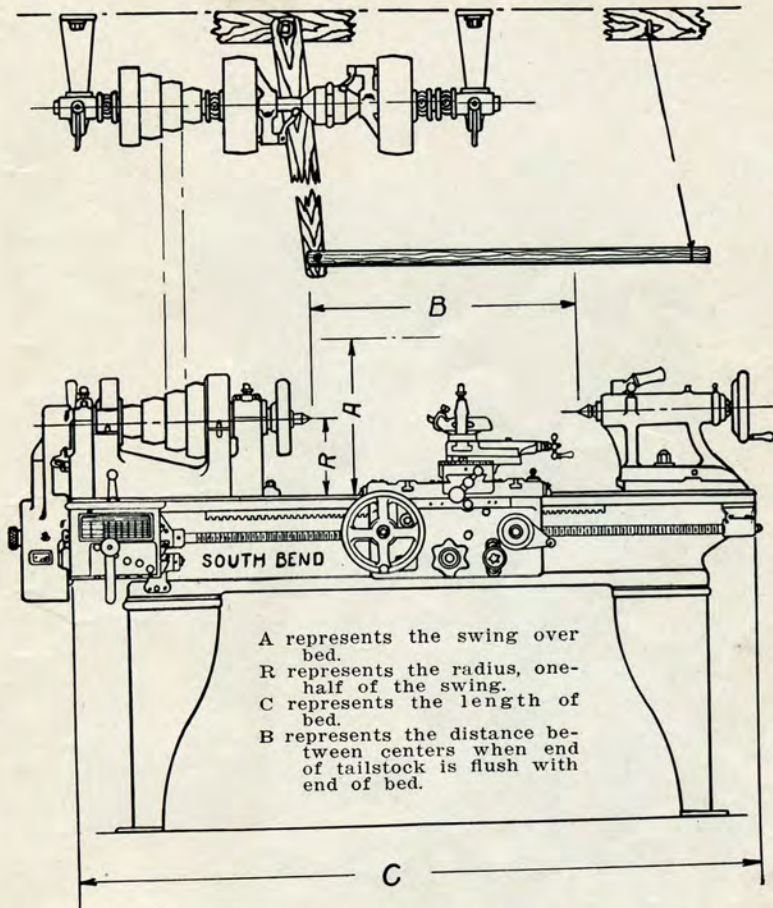
PRINCIPAL PARTS OF A MODERN BACK GEARED SCREW CUTTING PRECISION LATHE

- | | |
|-------------------------|-------------------------|
| A—Reverse | N—Tailstock |
| B—Back Gear Lever | O—Tailstock Hand Wheel |
| C—Back Gears | P—Sliding Gear |
| D—Spindle Cone | Q—Gear Box |
| E—Headstock | R—Leg |
| F—Headstock Spindle | S—Lead Screw |
| G—Face Plate | T—Rack |
| H—Saddle | U—Apron Hand Wheel |
| I—Cross Feed Ball Crank | V—Apron |
| J—Tool Post | W—Apron Clutch |
| K—Compound Rest | X—Cross Feed Lever Knob |
| L—Tailstock Spindle | Y—Apron Nut Cam |
| M—Tailstock Lever | Z—Lathe Bed |

A Blue Print of the above drawing, 28"x40", suitable for attaching to wall for instruction purposes, will be sent postpaid to any foreman or shop instructor, upon receipt of 25c in stamps of any country.

The photograph on page 8 shows a modern Quick Change, Back Geared Screw Cutting Precision Lathe and illustrates the basic design and principal features which apply to all sizes of lathes.

The principal features of the lathe, such as the headstock, tailstock, carriage, apron, compound rest, gear box, etc., are briefly described on page 9.



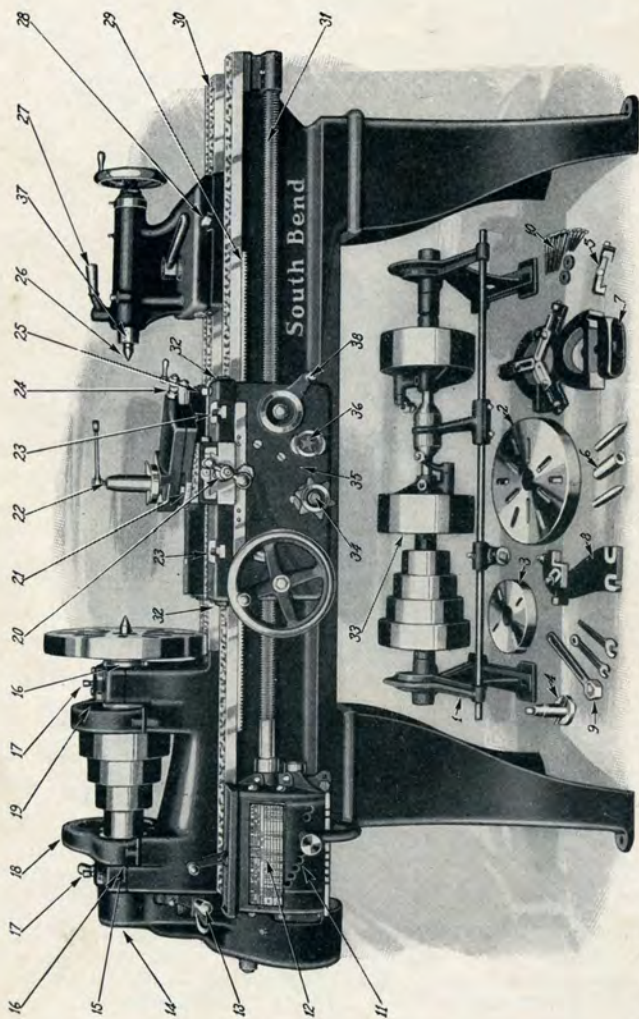
A represents the swing over bed.
 R represents the radius, one-half of the swing.
 C represents the length of bed.
 B represents the distance between centers when end of tailstock is flush with end of bed.

THE SIZE OF A LATHE

The size of a Screw Cutting Lathe is determined by the swing over bed and the length of bed. See drawing above.

European tool manufacturers determine the size of a lathe by its radius or center distance; for example, an 8-inch center lathe is a lathe having a radius of 8 inches. What the Europeans terms an 8-inch center lathe, the Americans call a 16-inch swing lathe.

When selecting the size of lathe for your work, take into consideration the largest diameter and the greatest length of the work. Then select the lathe that has a swing over bed and distance between centers at least 10% greater than the dimensions of the largest work to be handled.



THE DESIGN AND FEATURES OF A MODERN BACK GEARED SCREW CUTTING LATHE

- 2-10—Regular Lathe Equipment Parts.
 11—Quick Change Gear Box.
 12—Index Plate for Threads and Feeds.
 13—Quick-acting Latch Reverser.
 14—Special Carbon Steel Hollow Spindle.
 15—Hardened and Ground Steel Thrust Collar.
 16—Large Phosphor Bronze Bearings.
 17—Patent Oil Cups.
 18—Back Gears well guarded.
 19—Wrenchless Bull Gear Clamp.
 20—Micrometer Collar on Cross Feed Screw.
 21—Compound Rest graduated 180 degrees.
 22—Forged Steel Adjustable Tool Post.
 23—Slot for clamping work on Carriage.
 24—Micrometer Collar on Compound Rest Screw.
 25—Tool Steel Lock for feeding.
 26—Tailstock Spindle Lock.
 27—Tailstock Spindle Lock.
 28—Set-over Tailstock for taper turning.
 29—Steel Rack, cut from the solid.
 30—Semi-steel seasoned Lathe Bed.
 31—Precision Lead Screw, Acme Thread.
 32—Felt Shear Wipers and Oilers.
 33—Double Friction Countershaft.
 34—Automatic Friction Feed Clutch.
 35—Safety Device for Threads and Feeds.
 36—Knob for Automatic Feed.
 37—Graduated Tailstock Spindle.
 38—Half-nut Lever for thread cutting.

FEATURES OF A MODERN BACK GEARED SCREW CUTTING LATHE

The Illustration on page 8 shows the 16-inch Quick Change Back Gearing Screw Cutting Precision Lathe. The features described below are enumerated and shown on the opposite page, and apply to all sizes and types of New Model Lathes.

The Lathe Bed is a close grained casting of gray iron and steel mixture, containing 18 per cent steel, which gives it strength and wearing qualities. The bed is reinforced by box braces cast in at short intervals its entire length and has three prismatic "V" ways and one flat way for aligning the headstock, tailstock and saddle. The beds are rough planed and thoroughly seasoned, then finish planed and hand scraped. See page 141.

The Back Gearing Headstock is ruggedly constructed and scientifically braced to insure permanent alignment of the spindle bearings. It is equipped with a quick acting reverse lever for changing the direction of the automatic feeds. All gears are completely covered to comply with all State laws. A quick acting bull gear clamp permits engaging or disengaging the back gears without the use of a wrench. See page 131.

The Four-Step Spindle Cone is used on all lathes, 13-inch size and larger. The three-step cone provides ample speed range on the 9-inch and 11-inch lathes. The fourth or smallest step of the cone is the most valuable because it provides a wide range of speeds, for doing a great variety of work.

The Headstock Spindle is made of a special quality high carbon spindle steel. It has a hole its entire length for machining rods and bars through the lathe chuck and draw-in collet chuck. The steel thrust collar is hardened and ground.

The Phosphor Bronze Bearings for the headstock spindle are designed for heavy duty work and are adjustable for wear. The bearings are hand scraped to a perfect fit with the spindle. Patent oil cups insure an ample supply of oil to the bronze bearings.

The Tailstock is heavy and rigid with a long bearing on the bed. It has a set-over for taper turning and permits the compound rest to swivel parallel to bed. The tailstock spindle is graduated in 16ths

of an inch. The binding lever locks the spindle without disturbing the alignment of centers. See page 140.

The Carriage is strong and has a wide bridge. "T" slots are provided on the 13-inch size and larger for clamping work for boring and reaming. Felt shear wipers keep the "V" ways clean and oiled. The carriage is hand scraped to the lathe bed. The cross feed screw has Acme Thread and micrometer graduated collar reading in 1/1000 of an inch. Back of carriage is machined to receive Taper Attachment. A locking device fastens carriage to the bed when using the cross feed.

The Apron is provided with automatic cross feed and automatic friction longitudinal feeds. The apron is also provided with half-nuts which are used only when cutting screw threads. The lead screw is splined to serve as a feed rod for operating the automatic friction feeds. The threads of the lead screw are used only for cutting screw threads. An automatic safety interlock prevents the half-nuts and the automatic feeds from being engaged at the same time. See page 24.

The Compound Rest is graduated in degrees from 0 to 90° from center to each extremity of the arc. It can be clamped and operated at any angle and has an angular travel. The compound rest screw has Acme thread, and a micrometer collar graduated in 1/1000 of an inch. See page 80.

The Precision Lead Screw is made of special steel and has Acme standard threads cut on a special machine equipped with a Pratt and Whitney master lead screw. The lead screw is tested for form of thread and accuracy of lead and insures the utmost precision in cutting the finest thread gauges, master taps, etc. See page 140.

The Quick Change Gear Box provides forty-eight changes for cutting right and left hand standard screw threads from 2 to 112 per inch. It also provides for various adjustments of the automatic cross feeds and automatic longitudinal feeds. The index plate shows the arrangement of levers for cutting threads and operating the automatic feeds. See page 94.

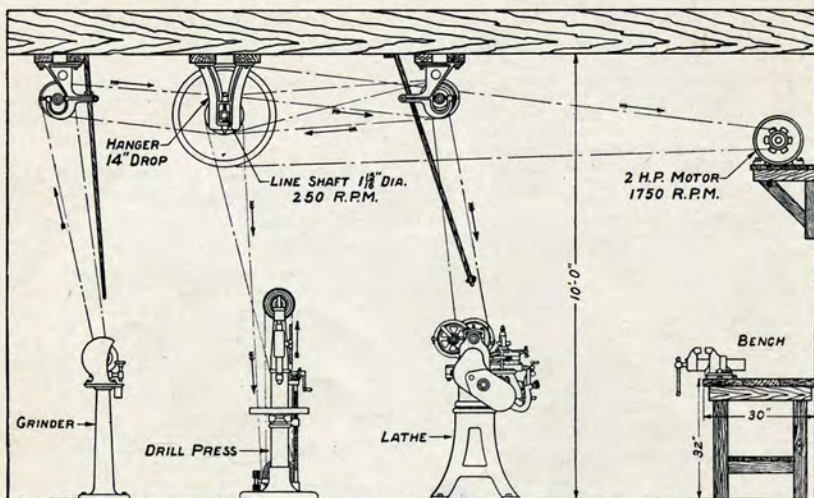


Fig. 401.—Layout of Small Machine Shop (end view)

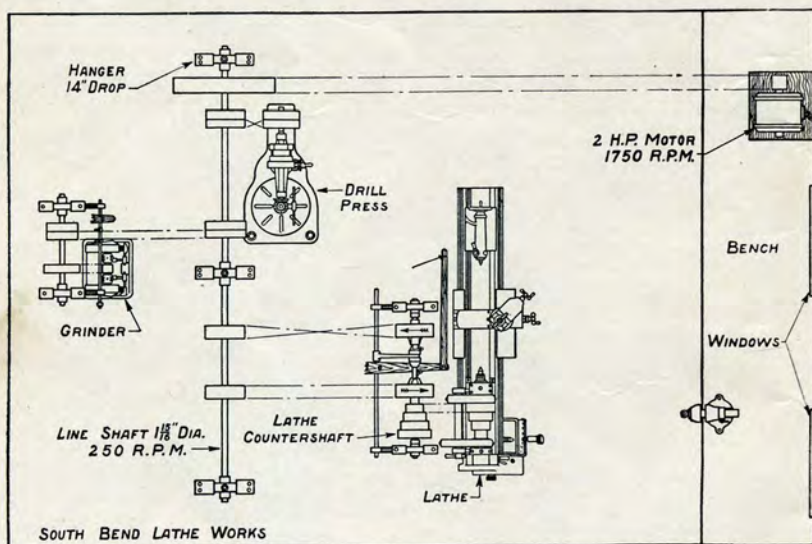


Fig. 402.—Layout of Small Machine Shop (plan view)

EQUIPMENT FOR SMALL MACHINE SHOP

The equipment consists of a 16" lathe, 20" Drill Press and 12" Emery Grinder.

The dimensions of this room as shown in the drawing are 20 feet wide, 15 feet long and 10 feet high.

LAYOUT OF THE EQUIPMENT FOR A SMALL MACHINE SHOP

The Lineshaft.—The Lineshaft is $1\frac{1}{8}$ " in diameter, has a speed of 250 R. P. M., and is supported by three hangers, each 14" drop. The length of the lineshaft depends upon the length of the shop room. The distance between lineshaft hangers should not be more than 8'.

Style of Drive.—The lineshaft drive is recommended for small machine shops rather than individual electric motor drive for each machine. The reason is that with a lineshaft, one motor will serve and a number of machines may be driven from this lineshaft.

Pulleys.—Wood pulleys, crown face, are recommended on the lineshaft, except for the grinder and the drill press, and as both of these machines have shifting belts the pulleys on the lineshaft should be straight face.

The Motor.—The Motor is a 2 H. P., constant speed, 1750 R. P. M., set on a bracket on the side wall, high enough so that the belt will not interfere with the workmen passing underneath.

This motor has ample power to run the three machines in the equipment, all under load at the same time.

The Lathe.—The Lathe is set in a position where the light shines over the right shoulder of the operator. There is plenty of space between the operator and the bench. The lathe countershaft has the left belt straight and the right belt crossed to lineshaft. For instructions for erecting the Lathe, see Page 12.

The Drill Press.—The Drill Press is set almost under the lineshaft, and is driven by a cross belt direct from the lineshaft.

The Grinder.—The Grinder is set on the opposite side of the lineshaft, and is driven by its countershaft from the lineshaft.

The Bench.—The Bench is made of wood and is 30" wide and 32" high.

INDIVIDUAL MOTOR DRIVE FOR THE LATHE

The Lathe, Drill Press and Grinder shown in the layout on page 10 may all be operated by individual motor drives if desired.

The Motor Drive Lathe is illustrated and described in detail on pages 122 and 123 of this book.

For the small shop where only 1, 2 or 3 machines are to be used the individual motor drive is preferred to the countershaft drive, the advantage being that installation is less expensive because it does not require lineshaft, hangers, belting, pulleys, etc.

LOCATING THE LATHE

The lathe, if possible, should be set on a solid concrete foundation. However, it may be set on a wood floor that is strong and substantial. If necessary, the floor should be securely braced below to prevent sagging.

Set the lathe so that the light will shine over the operator's right shoulder, and not closer than 18 inches to any other machine or to the wall. Allow at least 42 inches clearance on operator's side of lathe.

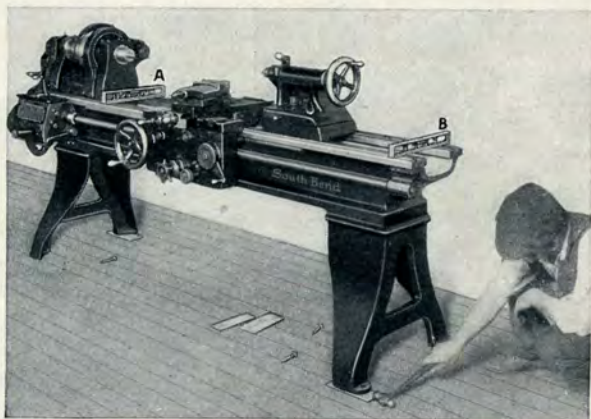


Fig. 403.—Leveling the Lathe

LEVELING THE LATHE

Fig. 403 shows the proper method of leveling a lathe. No lathe can do accurate work unless it is level and if at any time the machine is not doing accurate work first test to see if it is setting level.

To level a lathe use a graduated machinist's level at least 18" long. Place the level on the bed lengthwise on top of the "V" ways or the Flat way, both at the headstock end and at the tailstock end of the bed. Then place it across the bed in front of the headstock and shim under the leg in the direction indicated by the level. Next place the level across the bed at the tailstock end of the lathe and shim under the leg accordingly.

When the lathe bed is level in every direction, fasten to the floor or foundation and test again with the level as before. If not level, release the legs and adjust shim until lathe is level.

SHIMS FOR LEVELING

Pieces of sheet metal or slightly tapered steel serve to make the best shims, cut shingles or wooden shims may also be used, and sometimes cardboard or paper.

TO HANG THE COUNTERSHAFT

First: Place a plumb bob over the lineshaft in two different positions on the same side of the shaft about ten feet apart, to get a chalk line on the floor parallel to the lineshaft.

Second: Locate the lathe in the desired position parallel with the chalk line on the floor. Draw another line parallel with this lineshaft line about on center with the lathe bed under the head and tail spindles. Draw a third line 9" back of lathe center line, for the countershaft. These three lines should be parallel. Transfer the countershaft line to the ceiling by use of the plumb bob.

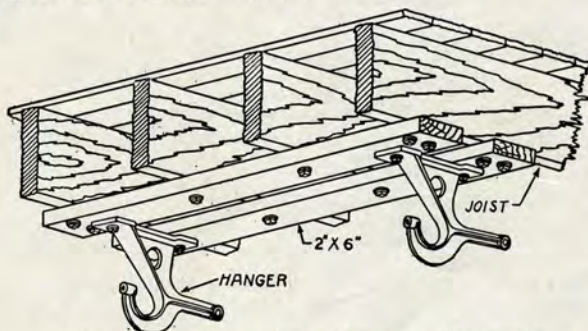


Fig. 404.—Attaching a Lathe Countershaft to Joists

Third: Bolt the countershaft hangers on the two 2x6s. Remove the shafting and pulleys. Fasten the 2x6s and hangers to the ceiling by lag bolts, as per illustration, to the joists so that the center line of the countershaft will be directly over and parallel to the countershaft center line as marked on the floor. It would be well to drill a small hole in the wood and put soap on the lag bolts, so they can be screwed in easily.

After the 2x6s are fastened to the ceiling, replace the countershaft in its hanger. The hangers are provided with longitudinal holes for adjustment. Adjust the hangers so that the countershaft will be parallel with the lineshaft. At the same time level the lineshaft. Fasten hangers securely to the 2x6s. See that shaft revolves freely, and that the set screws that hold the boxes are tight, and also fasten the jam nuts on the set screws. Note carefully the two collars inside the boxes. These collars should be fastened securely as they prevent end play of the countershaft. After these collars are fastened, try again and see that the countershaft revolves freely.

Specifications of Countershafts for South Bend Lathes

Size of Lathe	Size of C.S. Friction Pulley	Speed of Counter-shaft	Size of Lathe	Size of C.S. Friction Pulley	Speed of Counter-shaft
9 in.	6 $\frac{7}{8}$ x 2 $\frac{3}{16}$ in.	255 R.P.M.	16 in.	10 x 3 $\frac{5}{8}$ in.	225 R.P.M.
11 in.	6 $\frac{7}{8}$ x 2 $\frac{3}{16}$ in.	255 R.P.M.	18 in.	12 x 4 $\frac{1}{2}$ in.	167 R.P.M.
13 in.	8 x 2 $\frac{3}{8}$ in.	250 R.P.M.	24 in.	14 x 5 in.	161 R.P.M.
15 in.	10 x 3 $\frac{5}{8}$ in.	225 R.P.M.

RULES FOR CALCULATING THE SPEED AND SIZE OF PULLEYS

The driving pulley is called the driver and the driven pulley is the driven or follower.

R. P. M. indicates the number of revolutions per minute.

Problem 1.—The revolutions of driver and driven, and the diameter of the driven being given, required the diameter of the driver.

RULE.—Multiply the diameter of the driven by its number of revolutions, and divide by the number of revolutions of the driver.

Problem 2.—The diameter and revolutions of the driver being given, required the diameter of the driven to make a given number of revolutions in the same time.

RULE.—Multiply the diameter of the driver by its number of revolutions, and divide the product by the given number of revolutions of the driven.

Problem 3.—The diameter and number of revolutions of the driver, with the diameter of the driven, being given, required the revolutions of the driven.

RULE.—Multiply the diameter of the driver by its number of revolutions, and divide by the diameter of the driven.

Problem 4.—The diameter of the driver and driven, and the number of revolutions of the driven, being given, required the number of revolutions of the driver.

RULE.—Multiply the diameter of the driven by its number of revolutions, and divide by the diameter of the driver.

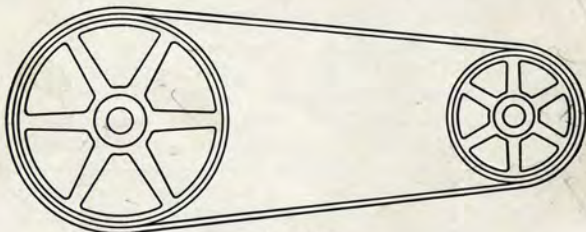


Fig. 405

One of the pulleys is the driver, the other is the driven.

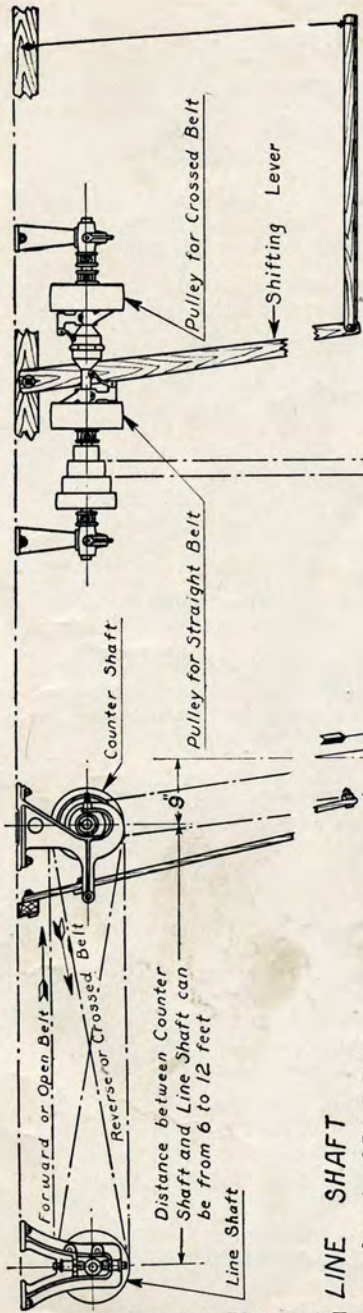
Example: Problem 1.

Given: Speed of the driving pulley 260 R.P.M. Speed of the driven pulley 390 R.P.M. Diameter of the driven pulley 8".

To Find the diameter of the driving pulley.

$$\begin{aligned} 390 \times 8 &= 3120 \\ 3120 \div 260 &= 12'' \end{aligned}$$

The diameter of the driving pulley is 12".



LINE SHAFT

Speed - 250 R.P.M.
 Pulleys - Wood Split, Crown Face
 Diameter of Line Shaft - $1\frac{5}{16}$ "

BELTING

Line Shaft to Counter Shaft -
 Single Ply Leather belt
 Counter Shaft to Lathe -
 Double Ply Leather belt
 Arrows indicate direction
 belts should run

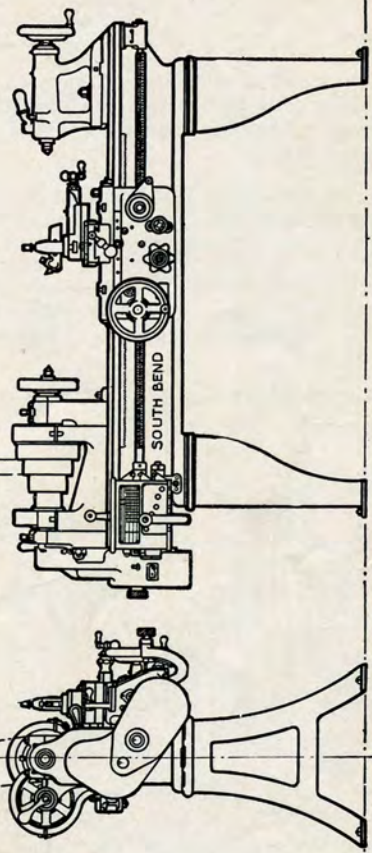


Fig. 406.—Setting Up of the Lathe

Foundation Plan and Erection Plan for Lathe, See Page 144.

LACING A LEATHER BELT

A leather belt should have the smooth or grain side running next to the pulley, because the smooth surface of the belt eliminates air pockets between the belt and the pulleys, and belt slipping is reduced to a minimum.

In measuring for the length of belt needed, place a steel tape or a strong cord over the pulleys that the belt is to run on. Draw taut and read the measurement on the tape, or cut the cord at the proper place.

Straighten the belt out on the floor and measure it with the cord or tape, drawing the cord as taut as you did when measuring over the pulleys. Mark the length of the belt with a square and cut off evenly.

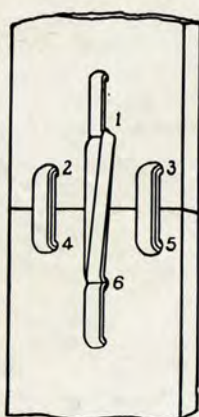


Fig. 407

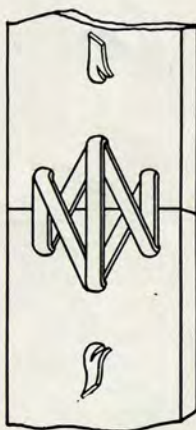


Fig. 408

Fig. 407.—Smooth Side of Belting

Fig. 407 shows the smooth or grain side of a 3-inch leather belt that has been laced. The lacing is not crossed on this side.

Fig. 408.—Rough Side of Belting

Fig. 408 shows the outer or rough side of the same belt. The lacing has been crossed on this side of the belt.

The holes for the rawhide or leather lacing should be punched a sufficient distance

from the edge in order not to weaken the belt. These holes should be just large enough to permit the lacing to be pulled through.

Fig. 407. Start lacing the belt on the smooth side by placing one end of the lace through hole No. 1, the other end through hole No. 6. Pull tight and even up at ends of the lacing. Lace alternately in the following order:

- From No. 6 to No. 2, and from No. 1 to No. 5.
- From No. 5 to No. 3, and from No. 2 to No. 4.
- From No. 4 to No. 2, and from No. 3 to No. 5.
- From No. 5 to No. 3, and from No. 2 to No. 4.
- From No. 4 to No. 1, and out and from No. 3 to No. 6.
- From No. 6 to No. 1, and from No. 1 to No. 6 and out.

In lacing wider belts, the same plan can be used as shown in above drawing. For example, a 5-inch belt requires 5 holes on the edge where the belt meets.

For information on leather belts see page 146.

SHIFTING A BELT

The belt running between the countershaft and the lathe spindle should be leather, double ply, and laced with rawhide lacing.

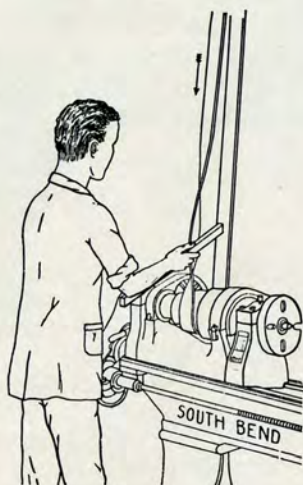


Fig. 409.—Shifting Belt on Lathe

Fig. 409 shows the method of shifting the belt on the spindle cone while the lathe is running. With a stick in his right hand, the operator pushes the belt from one cone step to another, keeping a firm hold on the stick.

To shift the belt on the countershaft cone to a larger step, the operator uses a long belt stick with an iron pin in the end, as shown in Fig. 410. While the countershaft is revolving, give the belt a sharp push and twist with the pin on the end of the stick.

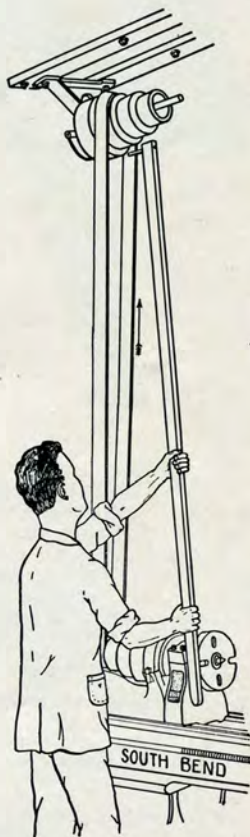


Fig. 410.—Shifting Belt on Countershaft

For the beginner, we recommend when shifting belts, he stop the lathe and shift by hand by pulling the belt, and slipping one side off of the larger step cone, then complete the shift to the desired position, and again turn by hand to run the belt in the proper position.

After a little experience of shifting by hand, he will learn how to shift the belt while the lathe is running.

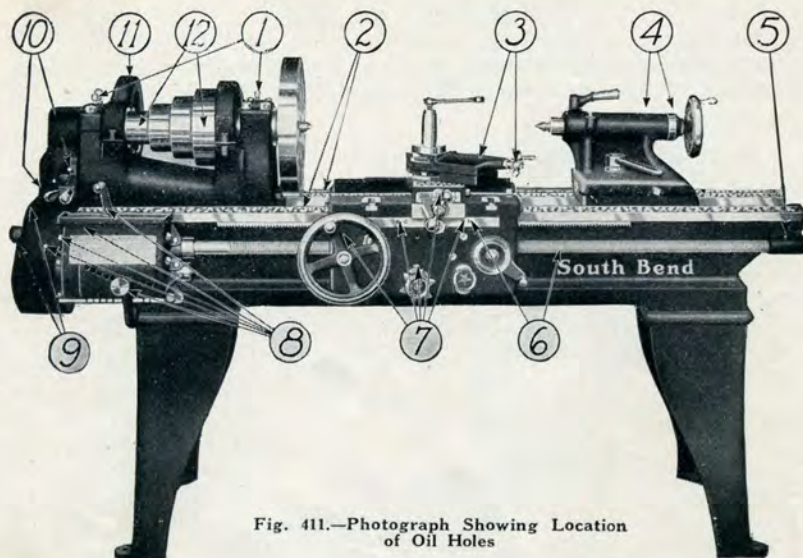


Fig. 411.—Photograph Showing Location of Oil Holes

OILING THE LATHE

The illustration above shows a lathe with the principal oil holes indicated by arrows. Oil the lathe at regular intervals, locating the various oil holes and bearings as indicated in the instructions below. Start with oil hole marked "1" and follow through in regular order, 2, 3, 4, etc. One of the greatest causes of wear and destruction of the parts of the lathe is that the operator fails to give them the correct amount of oil at the proper time.

INSTRUCTIONS FOR OILING LATHE UNITS

- | | |
|-------------------------------------|--|
| 1—Headstock Spindle Bearings..... | Fill the oil cups every hour the first 100 hours, twice a day thereafter. |
| 2—Carriage "V" Ways and Dovetails.. | Keep clean and well oiled. |
| 3—Compound Rest Screw..... | Remove the two small screws in the Compound Rest Top to oil, once a day. |
| 4—Tailstock Screw | Fill both oil holes once a day. |
| 5—Lead Screw Bearings..... | Fill the oil cup once a day. |
| 6—Lead Screw and Half-Nuts..... | Oil every hour when in use. |
| 7—Apron Bearings | Fill all oil holes once a day. |
| 8—Gear Box Bearings..... | Fill all oil holes once a day. Place tumbler in extreme left hole when oiling. |
| 9—Primary Gears | Fill oil holes once a day. |
| 10—Reverse Lever | Oil studs and fill oiler once a day. |
| 11—Back Gears | Remove oil plug and fill reservoir daily. |
| 12—Spindle Cone Pulley..... | Fill oil reservoir twice a day first week. Once a day thereafter. |

Keep the Lead Screw Clean and Well Oiled and Its Accuracy Will Be Preserved

OILING THE LATHE

Keeping the lathe well oiled has much to do with the life of the lathe and the quality of the work it will turn out. Follow these directions carefully if you wish to keep your lathe in first class condition.

First.—Use only a good grade of machine oil, equal in quality to Atlantic Red, in oiling the lathe. Oil all bearings regularly as directed in Fig. 411.

Second.—Always oil in the order indicated so that no holes will be missed. If you do this you will soon form the habit and the oiling will require only a very short time.

Third.—Do not use an excess of oil. A few drops is sufficient and if more is applied, it will only run out of the bearings and get on the machine, making it necessary for you to clean the machine more frequently.

Fourth.—After you have completed the process of oiling the lathe and countershaft wipe off the excess oil around the bearings with a clean cloth or waste.

Fifth.—Take pride in keeping the lathe clean and neat. You will do better work on a clean machine than a dirty one. If compressed air is available, use this occasionally to blow off all dirt and refuse.

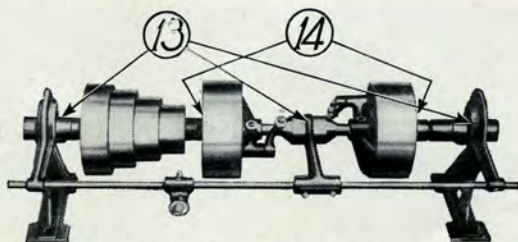


Fig. 412.—Countershaft for Lathe

OILING THE COUNTERSHAFT

The illustration above shows a double friction countershaft used for driving the lathe. The principal oil holes are indicated by arrows. Oil the countershaft as regularly as the lathe itself. The fact that the countershaft is not as easy to get to as the lathe, is no excuse for slighting it. Oil it every day as follows:

- 13—Countershaft BearingsOil every day.
 14—Friction Clutch Pulleys.....Fill oil cups twice daily first week,
 once a day thereafter.

Neither the lathe nor the countershaft should be oiled while the machine is in motion.



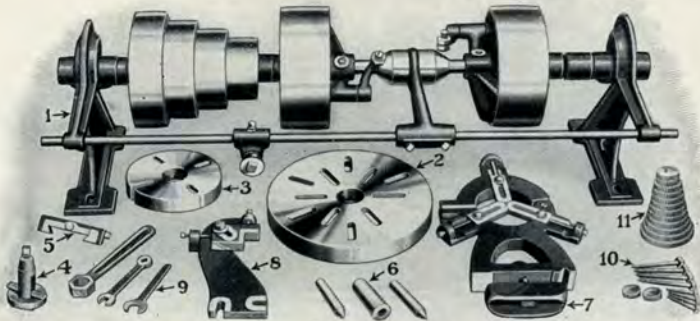
ASSEMBLING LATHES IN GROUPS OF TWENTY-FIVE

The illustration shows an assembly room in the factory of the South Bend Lathe Works where lathes are assembled and tested in groups of twenty-five. Then each lathe is set under belt, operated and tested before leaving the factory.



A GROUP OF SIXTEEN LATHES IN OPERATION IN A FACTORY

The illustration above shows a group of sixteen Lathes that are being used in a manufacturing plant, producing metal parts. These Lathes are all driven by overhead countershafts, which are driven from an overhead line shaft. One 15 H.P. Motor supplies sufficient power to drive all of these Lathes. The Motor can be seen on the side wall.



COUNTERSHAFT AND REGULAR EQUIPMENT OF A MODERN BACK GEARED SCREW CUTTING PRECISION LATHE

The regular equipment of a Screw Cutting Lathe is shown above and is included in the price of the lathe. On the arrival of the new lathe, check off each part of the equipment as described in the list below to see that none of the parts are lost or broken. The items illustrated above are furnished with all Regular Quick and Standard Change Gear Lathes.

1. The Improved Double Friction Countershaft is efficient and durable. It is accurately balanced and can be operated at high speed without vibration. Two Drive Pulleys equipped with Quick Acting Rim-Grip Friction Clutches expand against the rim. One Pulley used for cross belt furnishes reverse drive. Oil wells and felt pads lubricate the hub of the clutch pulleys. The countershaft bearings are adjustable in the hangers and are provided with felt wick oilers.

2. The large Face Plate threaded and fitted to the spindle nose of lathe.

3. The small Face Plate threaded and fitted to the spindle nose of lathe.

4. Tool Post, Ring, Wedge and Wrench are drop forged steel, case hardened. The Tool Post set screw is tool steel hardened and tempered.

5. Adjustable thread cutting stop for regulating the depth of chip in thread cutting.

6. Two tool steel Lathe Centers, one soft for head and the other hard for tail spindle and a taper sleeve for the head spindle.

7. Center Rest to support long, slender work while being turned and for supporting work while drilling, boring, reaming, etc.

8. Follower Rest which travels with the cutting tool for supporting long, slender work while being machined between centers.

9. Wrenches for Tailstock, Compound Rest and Tool Post.

10. Lag Screws for fastening lathe and countershaft.

11. Change Gears for thread cutting, automatic cross and longitudinal feeds, on Standard Change Gear Lathes.

Note: Change Gears are not required on Quick Change Gear Lathes as the gear box takes care of the changes. Change Gears are furnished only with Standard Change Gear Lathes.

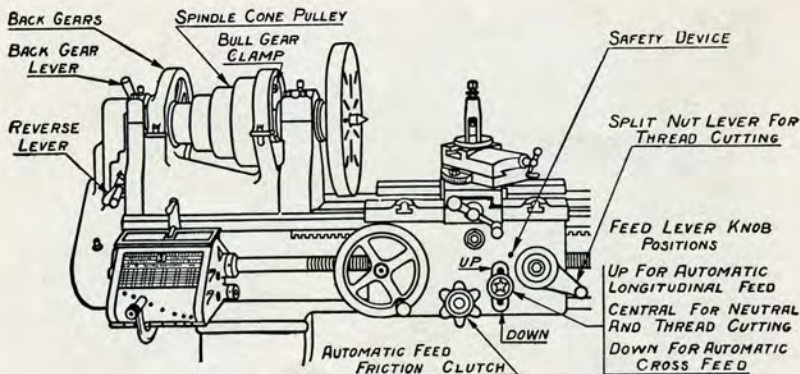


Fig. 413.—Operating Parts of a Lathe

STARTING THE NEW LATHE

Before starting the new lathe, study the action of the principal operating parts. These are marked in the illustration above and described herewith.

DIRECT CONE DRIVE OF THE SPINDLE

To prepare the spindle to operate on direct cone drive, throw the back gear lever outward from you. This causes the back gears to move out of mesh. Then pull the quick acting bull gear clamp plunger out and slide it upward until it enters the recess in the spindle cone. If the bull gear clamp does not enter the recess readily, rotate the cone until you feel the clamp entering the slot. Then release the bull gear clamp plunger and the spindle is connected for direct cone drive.

BACK GEAR DRIVE OF THE SPINDLE

To connect the back gears with the spindle, adjust the quick acting bull gear clamp to a down position. This disconnects the cone and allows it to revolve freely on the spindle. Then pull the back gear lever forward. This will bring the back gears into mesh. The lathe is now connected for back gear drive.

Never throw the back gears IN or OUT of mesh while the lathe spindle is revolving.

THE REVERSE LEVER

The quick acting spring latch reverse lever is located on the left hand end of the head stock. It is used to connect the lathe spindle through a train of gearing, with the lead screw to drive the carriage in either direction. This reverse lever has three positions: position **up**, position **central** and position **down**. When the reverse lever is in central position, the lead screw is disconnected from the spindle.

Never change the position of the reverse lever in either direction while the lathe spindle is revolving.

THE AUTOMATIC FRICTION CLUTCH

The automatic friction clutch controls the operation of both the automatic longitudinal feed and the automatic cross feed. If, therefore, the automatic feeds are not in use, the friction clutch knob should be loosened or unscrewed a couple of turns to the left.

THE AUTOMATIC FEED LEVER KNOB

The automatic feed lever knob is used for operating the automatic longitudinal feed and the automatic cross feed. The automatic feed lever knob in the apron has three positions: position **up**, position **central** and position **down**.

AUTOMATIC LONGITUDINAL FEED OF THE CARRIAGE

To connect the automatic longitudinal feed of the carriage of a Quick Change Gear Lathe to feed from right to left in the direction of the head stock, move the reverse lever to a **down** position. Move automatic feed lever knob into **up** position and fasten, then tighten automatic friction clutch.

For the Standard Change Gear Lathe, the position of the reverse lever for automatic longitudinal feed may be up or down according to whether simple or compound gearing connects the spindle with the lead screw.

AUTOMATIC CROSS FEED

To connect the automatic cross feed on a Quick Change Gear Lathe, loosen the automatic feed lever knob and move it to **down** position and fasten, then tighten the automatic friction clutch. The automatic cross feed is in action for feeding the tool in the direction of the operator from the axis of the spindle, providing the reverse lever is in **down** position.

For the Standard Change Gear Lathe the position of the reverse lever for automatic cross feed, may be up or down according to whether simple or compound gearing connects the spindle with the lead screw.

The automatic feed lever knob is controlled by a safety device. For example: when cutting a thread the automatic feed lever knob is locked in central position and while in this position, it is impossible for either of the automatic feeds to get into action. For description of safety device see page 24.

SPLIT NUT LEVER FOR THREAD CUTTING

The split nut lever controls the split nuts or half nuts in the apron that clamp on the lead screw for thread cutting.

When the split nut lever is in down position the split nuts are open, and out of contact. When the split nut lever is in up position, the split nuts are clamped on the thread of the lead screw ready for thread cutting.

The thread of the lead screw is used for thread cutting only, as both the automatic feeds in the apron are driven by the spline in the lead screw and not by the thread of the lead screw.

SAFETY DEVICE FOR SOUTH BEND LATHES

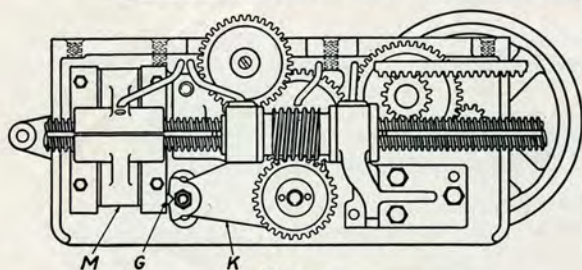


Fig. 414

the lead screw while either the automatic cross feed or automatic longitudinal feed is in action.

Figure 414 shows the interior view of the improved apron on South Bend Lathes. "G" Safety device. "K" Automatic feed lever. "M" Split half nuts.

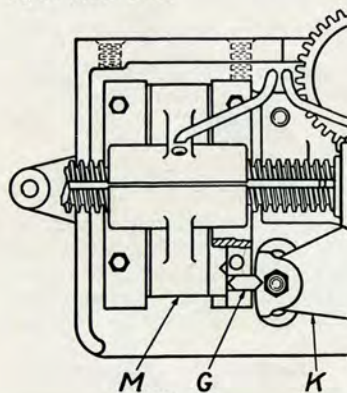


Fig. 415

Set for Thread Cutting

Figure 415 shows the mechanism of the casting cut away to show the action of the safety device when cutting threads. Split nuts "M" are closed on the lead screw. Feed lever "K" is locked in neutral position.

Set for Automatic Feed

Figure 416 shows the safety device "G" locking split half nuts in an open position. It also shows the feed lever "K" in position for operation of automatic longitudinal feed. For automatic cross feed operation, slide feed lever "K" to the bottom of the slot.

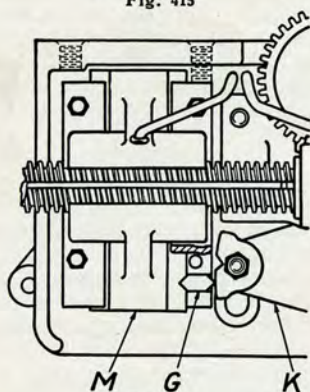


Fig. 416

Safety Device is Fool Proof

This safety device is fool proof. It works automatically without any attention from the operator. The feed mechanism is also fool proof, as the automatic cross feed and the automatic longitudinal feed cannot be engaged at the same time.

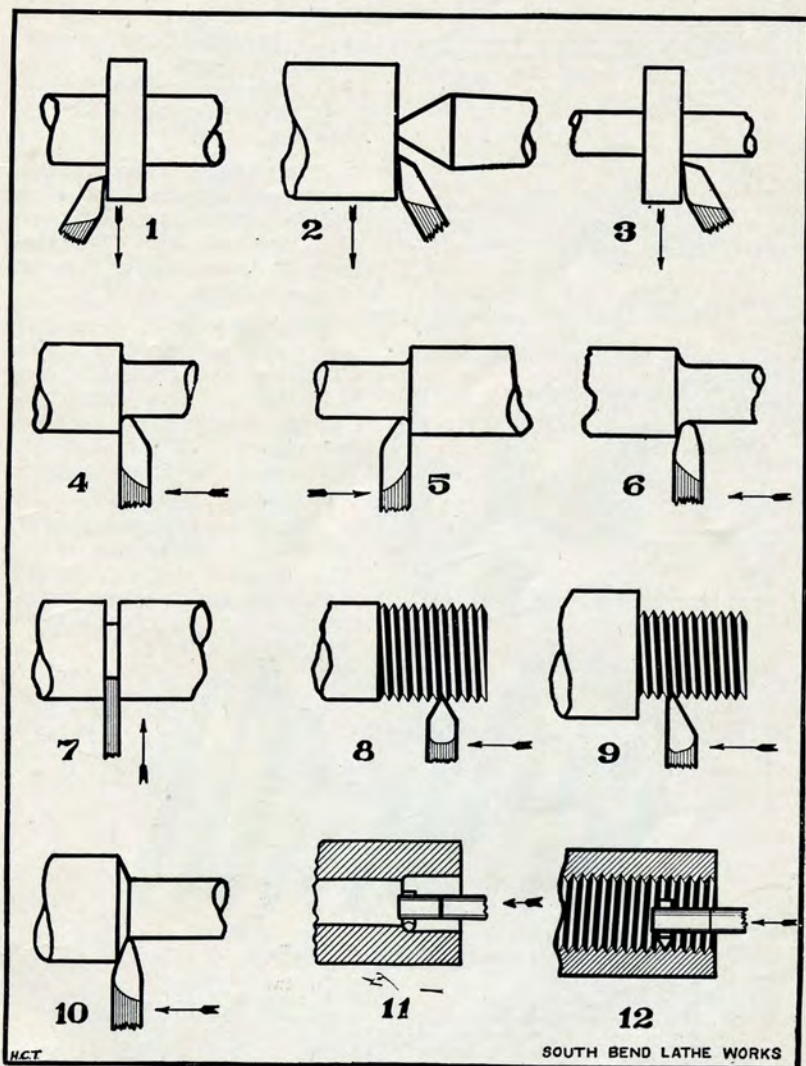


Fig. 417.—Application of Lathe Tools

CUTTING TOOLS FOR LATHE

- | | |
|---------------------------------|------------------------------------|
| No. 1. Left Hand Side Tool. | No. 7. Cutting-off Tool. |
| No. 2. Right Hand Side Tool. | No. 8. Threading Tool. |
| No. 3. Right Hand Corner Tool. | No. 9. Right Hand Threading Tool. |
| No. 4. Right Hand Turning Tool. | No. 10. Round Nose Finishing Tool. |
| No. 5. Left Hand Turning Tool. | No. 11. Boring Tool. |
| No. 6. Round Nose Turning Tool. | No. 12. Internal Threading Tool. |

Note: A large 12"x18" blue print of this page can be furnished for wall mounting in the school shop if desired. Price 10c.

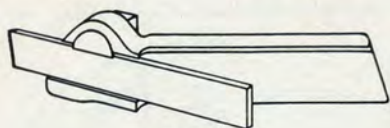


Fig. 418

Fig. 418 is a cutting off tool, hardened and ground, ready for use. The blade has clearance on both sides, and requires grinding only on the end.

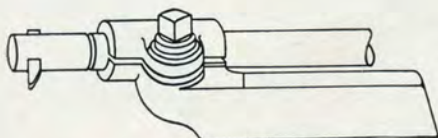


Fig. 419

Fig. 419 is a boring tool with an adjustable bar in which small hardened steel bits are inserted. This tool may be used also for internal thread cutting.

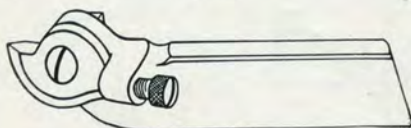


Fig. 420

Fig. 420 is a threading tool, the cutter of which is hardened and ground, and is adjustable. This cutter requires grinding on the top edge only. It therefore always remains true to form and angle.

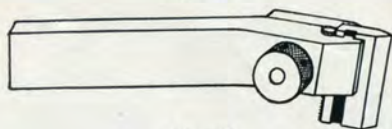


Fig. 421

Fig. 421 is a threading tool, holding an adjustable cutter that is hardened and ground to shape, and requires grinding on the top edge only to sharpen.

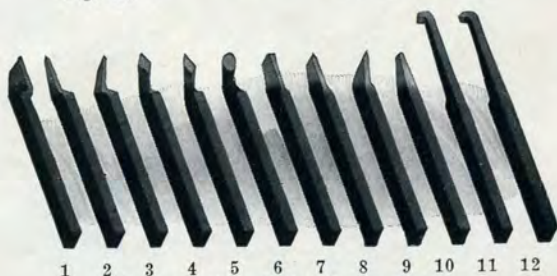


Fig. 422. Forged Steel Lathe Tools

- | | |
|------------------------------|----------------------------|
| 1. Left-hand Side Tool. | 7. Cutting-Off Tool. |
| 2. Right-hand Side Tool. | 8. Threading Tool. |
| 3. Right-hand Bent Tool. | 9. Bent Threading Tool. |
| 4. Right-hand Diamond Point. | 10. Roughing Tool. |
| 5. Left-hand Diamond Point. | 11. Boring Tool. |
| 6. Round Nose Tool. | 12. Inside Threading Tool. |

FORGED STEEL LATHE TOOLS

Fig. 422 shows twelve forged carbon steel lathe tools used in the various machining operations on the lathe. The forged lathe tool is used more on large lathes for heavy work.

High Speed Forged Steel Lathe Tools

The twelve forged steel lathe tools illustrated above may also be made of high speed steel.

LATHE TOOLS

The lathe tool is used for the cutting and machining of metals in the lathe. It is held in the tool post of the compound rest, and is fed to the revolving work by hand feed or by automatic feed.

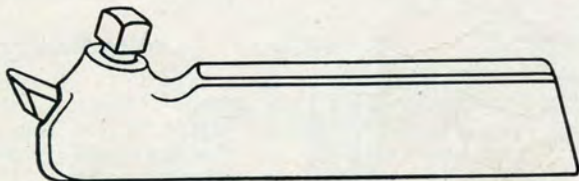


Fig. 423.—Tool Holder with Inserted Cutting Bits of High Speed Steel

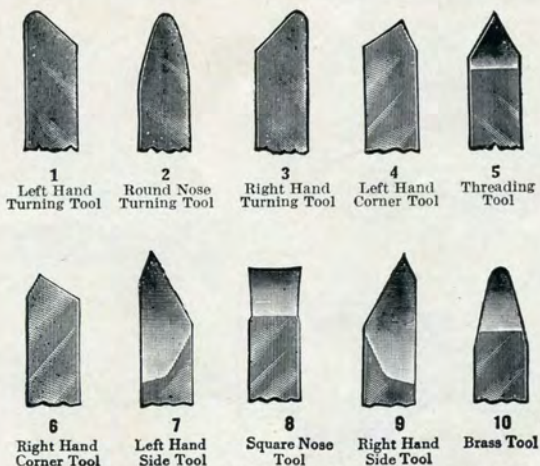


Fig. 424.—High Speed Cutting Bits Ground to Form

Right hand.—A right hand tool is one that takes a cutting chip while the feed is operating from right to left, or feeding towards the head stock.

Left hand.—A left hand cutting tool is one that takes a cutting chip from left to right, or feeding towards the tail stock.

HIGH SPEED STEEL BITS

Require grinding only to make them ready for use in Lathe Tool Holders



High Speed Steel Bits for Tool Holders

Size of Squares.	$\frac{3}{16}$ "	$\frac{1}{4}$ "	$\frac{5}{16}$ "	$\frac{3}{8}$ "	$\frac{7}{16}$ "
Length.	$1\frac{3}{4}$ "	$2\frac{1}{8}$ "	$2\frac{3}{4}$ "	$3\frac{1}{4}$ "	$3\frac{3}{4}$ "

GRINDING OR SHARPENING THE CUTTING EDGE OF THE LATHE TOOL

The efficiency of the lathe tool depends a great deal upon the way it is ground or sharpened. The cutting edge of the tool must have the proper side clearance, front clearance, side rake and back rake.

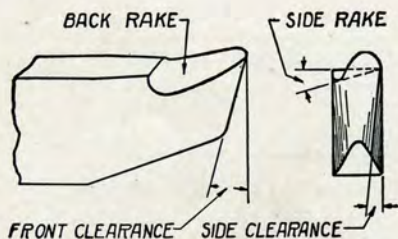


Fig. 425

Cutting Edge of Tool

Fig. 425 illustrates the front clearance, the side clearance, the side rake and the back rake of the cutting edge of the tool. All of these angles are important, and should be remembered when grinding a cutting tool.

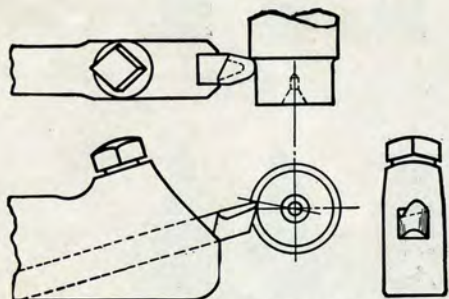


Fig. 426.—For Cutting Mild Steel

Angle of Tool for Cutting Mild Steel

Fig. 426 illustrates a ground cutting tool for the machining of mild steel.

The angles of back rake and side rake are quite pronounced, as are also the angles of front clearance and side clearance.

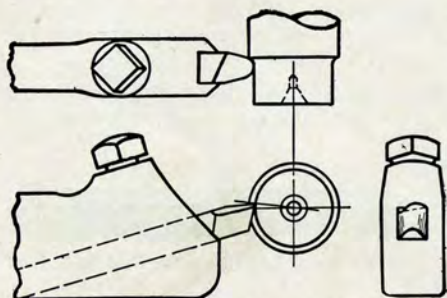


Fig. 427.—For Cutting Carbon Tool Steel and Cast Iron

Angle of Tool for Cutting High Carbon Steel and Cast Iron

Fig. 427 illustrates the tool for cutting annealed tool steel and high carbon steel and cast iron. The angle of clearance and rake are not so sharp as in the tool for cutting steel, but then there is sufficient slope and clearance.

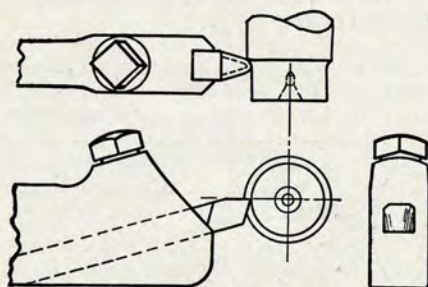


Fig. 428.—Turning Tool for Bronze Work

Angle of Tool for Cutting Bronze and Brass

Fig. 428 shows the turning tool ground for machining bronze and brass. You will note that the tool has no back or side rake, and that the cutting edge of the tool is on the center line.

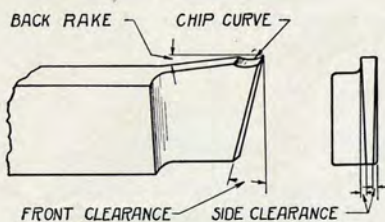


Fig. 429.—Cutting Off Tool

Fig. 429 shows a cutting off or parting tool ground for machining both steel and cast iron. There is back rake, a chip curve, front clearance and side clearance but no side rake. The side clearance is very important on a cutting off tool.

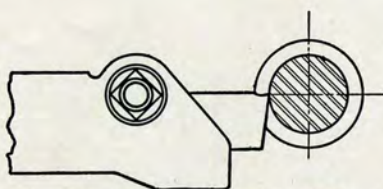


Fig. 430.—Cutting Off Tool in Holder

Fig. 430 shows a cutting off tool in a tool holder. Note that the cutting edge of the tool is on a center line with the work.

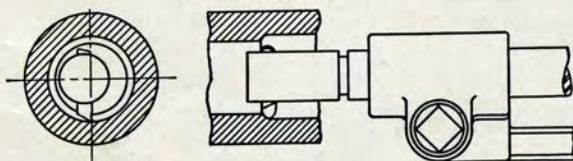


Fig. 431.—Boring Tool Cutting Edge

Fig. 431 shows the cutting edge of a boring tool. There is both a side rake and a back rake to this cutting edge and the front and side clearance is

about the same as for the turning tool. The height of the cutting edge is exactly on the center line.

HEIGHT OF THE CUTTING TOOL FOR TURNING STEEL AND CAST IRON

The position of the cutting edge of a turning tool for machining metal is important. In the cutting of mild steel and cast iron, the best results are obtained when the cutting point of the tool is about $\frac{3}{4}$ " above the center for each inch in diameter of the work.

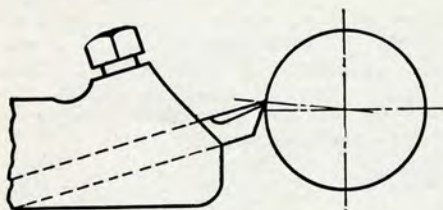


Fig. 432.—Position of Turning Tool

Insert the tool holder in the tool post and raise or lower the point of the tool to the height indicated in the preceding paragraph by moving the wedge in or out of the tool post ring. To test this height run the cross slide in until the point of the tool is opposite the tail center point.

HOLDING THE TOOL IN THE TOOL POST

The tool holder should be held firmly in the tool post. The end of the holder should not extend too far from the edge of the compound rest. See "B," Fig. 433, which is about the correct distance.

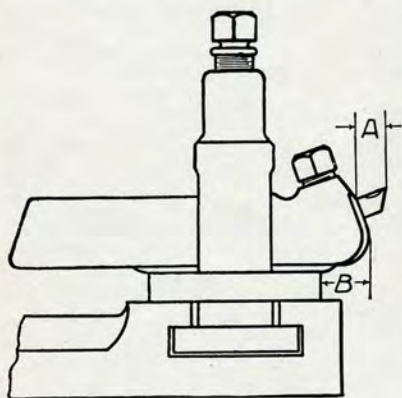


Fig. 433.—The Tool Holder

The cutting edge of the tool bit should not extend far beyond the holder. See "A," Fig. 433 which is about the correct distance. When the tool bit extends too far from the holder or the tool holder extends too far from the tool post, the tool will spring and the tool point catch in the work, destroying both tool and work.

KEEP THE CUTTING TOOLS SHARP

The cutting tools must have a sharp, keen edge, in order to do fine accurate work. First-class workmen take pride in keeping their tools in condition. After grinding a tool on the emery wheel, its wearing qualities will be improved if it is honed by hand with a small oil stone, using a couple of drops of oil.

MEASURING WITH CALIPERS

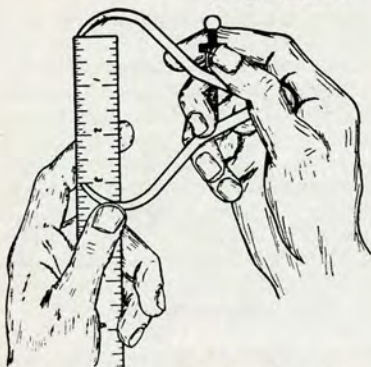


Fig. 434.—Setting the Outside Caliper

Setting an Outside Caliper to a Steel Scale

Fig. 434 shows a method of setting an outside caliper to a steel scale. The scale is held in the left hand and the caliper in the right hand. The caliper is supported by the thumb of the left hand and the adjustment is made with the thumb and first finger of the right hand.

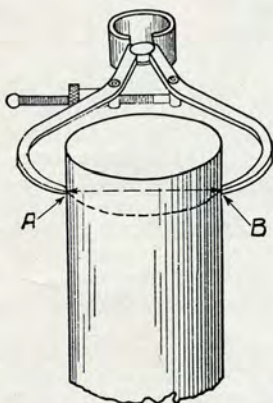


Fig. 435.—Position of Caliper in Measuring Diameters

Correct Position of the Caliper in Measuring the Diameter of a Cylinder

Fig. 435 shows the proper application of the outside caliper when measuring the diameter of a cylinder or a shaft. Note the dotted line connecting points "A" and "B" where the caliper comes in contact with the work, is at right angles to the center line of the work, and at a point where the true diameter of the cylinder can be measured. When the caliper measures properly, it should just slip over the shaft of its own weight. Never force a caliper. It will spring and the measurement will not be accurate.

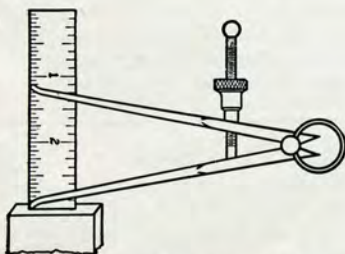


Fig. 436.—Setting the Inside Caliper

Setting an Inside Caliper to a Scale

To set an inside caliper for a definite dimension, place the end of the scale against a flat surface and the end of the caliper at the edge and end of the scale. Adjust the other end of the caliper to the required dimension.

APPLICATION OF INSIDE CALIPER

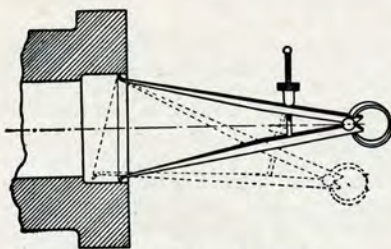


Fig. 437.—Using the Inside Caliper

In measuring the diameter of a hole place the caliper in the hole as shown on the dotted line and raise the hand slowly. Adjust the caliper in the meantime, then take another cut with the boring tool, and test with the caliper again. Continue until the proper dimension is obtained. **Do not force the caliper.** Develop a fine "caliper touch." Be sure the points of the caliper are across the diameter of the hole being measured.

Transferring Measurement from an Outside to an Inside Caliper

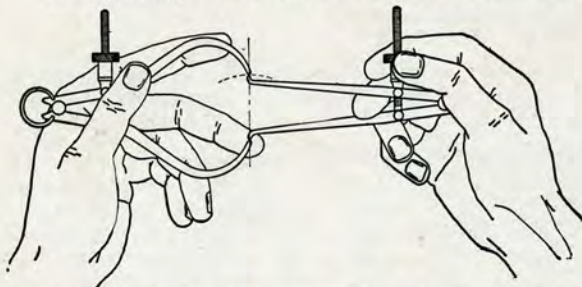


Fig. 438.—Transferring Measurement from an Outside to an Inside Caliper

Fig. 438 shows the method of transferring measurement from an outside to an inside caliper. The point of one leg of the inside caliper rests on a similar point of the outside caliper. Using this contact point as

a pivot, move the inside caliper along the dotted line shown in illustration, and adjust with the thumb screw until you feel your measurement is just right.

If you wish to transfer measurement from an inside caliper to an outside caliper, reverse the process described above, holding the inside caliper in the left hand and the outside caliper in the right hand.

Caliper FEEL

The accuracy of all contact measurements is dependent upon the touch or feel. Therefore the contact measuring tool should be held by the fingers only, and in such a way as to bring it in contact with the finger tips. The caliper should be delicately and lightly held, instead of gripped tightly, because if the caliper is gripped harshly between the fingers, the sense of touch is very much impaired.

LATHE CATALOG

If interested in securing further information on any of the lathes, tools or accessories described in this hand book, write for a free copy of our illustrated catalog, which describes the entire line, also giving the prices.



Fig. 439.—Using a Micrometer Caliper Measuring Work in the Lathe



Fig. 440.—Using an Internal Micrometer Caliper Measuring the Diameter of a Machined Hole

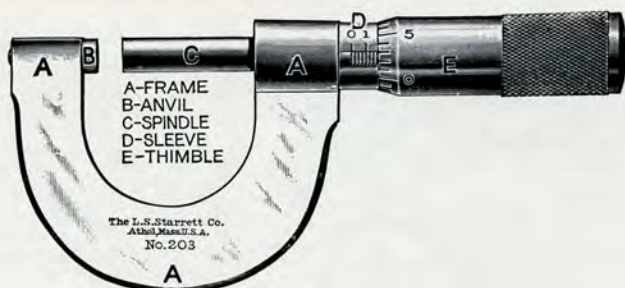


Fig. 441

HOW TO READ A MICROMETER

The pitch of the screw threads on the concealed part of the spindle is forty to an inch. One complete revolution of the spindle, therefore, moves it lengthwise one fortieth (or twenty-five thousandths) of an inch. The sleeve D is marked with forty lines to the inch, corresponding to the number of threads on the spindle.

Each vertical line indicates a distance of one-fortieth of an inch. Every fourth line is made longer than the others, and is numbered 0, 1, 2, 3, etc. Each numbered line indicates a distance of four times one-fortieth of an inch, or one tenth.

The beveled edge of the thimble is marked in twenty-five divisions, and every fifth line is numbered, from 0 to 25. Rotating the thimble from one of these marks to the next moves the spindle longitudinally one twenty-fifth of twenty-five thousandths, or one thousandth of an inch. Rotating it two divisions indicates two thousandths, etc. Twenty-five divisions will indicate a complete revolution, .025 or one-fortieth of an inch.

To read the micrometer, therefore, multiply the number of vertical divisions visible on the sleeve by twenty-five and add the number of divisions on the bevel of the thimble, from 0 to the line which coincides with the horizontal line on the sleeve. For example, in the engraving, there are seven divisions visible on the sleeve. Multiply this number by twenty-five, and add the number of divisions shown on the bevel of the thimble, E. The micrometer is open one hundred and seventy-eight thousandths. ($7 \times 25 = 175 + 3 = 178.$)

Note: For tables of decimal equivalents in the English and Metric Systems see page 147.

Young man, learn the machinist's trade, learn mechanical drawing. If you master both subjects you will be a trained man and your future will be limited only by your ability.

CENTERING

To machine a job on centers in the lathe it is necessary that a hole be drilled in each end of the work so it can revolve on the lathe centers. These holes are called countersunk center holes.



Fig. 442.—The Hermaphrodite Caliper

Locating Centers with a Hermaphrodite Caliper

Place the work to be centered in a vise. Face the end of the work with chalk and then rub in with your finger so that the marks of the caliper can be seen. Set the caliper to a little over half of the diameter of the stock and mark as shown in Fig. 442. Drive the center punch point in the center of these marks. Repeat this operation on the other end of the work.

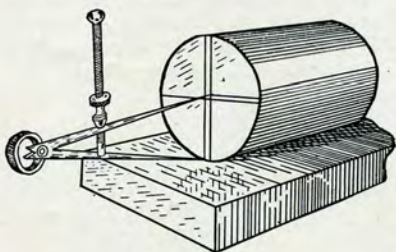


Fig. 443.—Dividers

Locating Centers with Surface Plate and Dividers

If hermaphrodite calipers are not available, the center can be located with a surface plate and dividers. See Fig. 443.

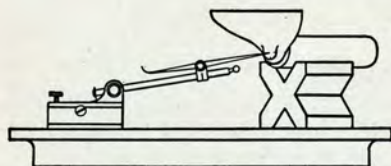


Fig. 444.—Surface Gauge and V-Block

Locating Centers with Surface Gauge and V-Block

When work is of irregular shape, a surface gauge can be used to locate the centers. See Fig. 444. This shows the tool rest of an emery grinder on a V-Block on a surface plate. The centers at both ends of this tool rest are located by the aid of the surface gauge.

George Westinghouse, Henry Ford and Orville Wright got their early mechanical training on a small screw cutting lathe.

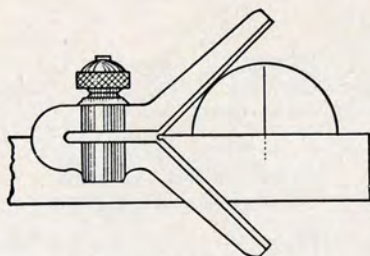


Fig. 445.—Center Head

Locating Centers with a Center Head

Another method of locating the centers is with a center head as shown in Fig. 445. Make a mark along the side of the blade on the end of the work, then turn the square one-quarter way around and make a similar mark on the end. This is a quick method of locating the center on round stock.



Fig. 446.—Center Punch

Punching the Center Point

Location of the center being found, place the center punch at the intersection of the lines and tap with a hammer, making a mark sufficiently deep so that the work will revolve on the center points when placed on centers in the lathe. See Fig. 446.

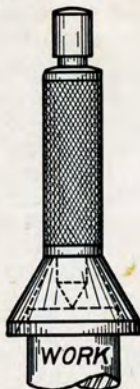


Fig. 447.—Bell Cup Center Punch

Bell Cup Center Punch

Fig. 447 shows the application of a bell cup center punch centering a small cylindrical piece of work. The bell cup is placed over the end of the work and the center punch or plunger slides through this cup. Hit the plunger a sharp blow with the hammer and it will immediately locate the center. This method is used mostly in production where a great many small pieces are to be centered.

TESTING THE WORK ON CENTERS

After a piece has been centered on both ends by the center punch, place the work on centers in the lathe. Clamp the tail stock and bring the tail stock center up tight enough so that the work will be supported between centers. With a piece of chalk in the right hand, revolve the work with the left hand and mark the high spots on each end of the cylinder.

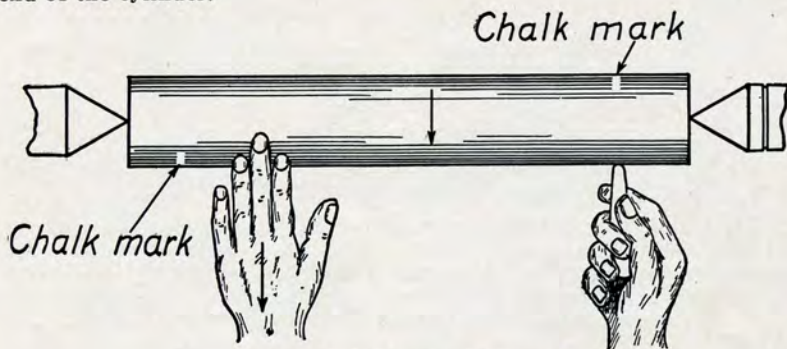


Fig. 448.—Testing the Work on Center Points

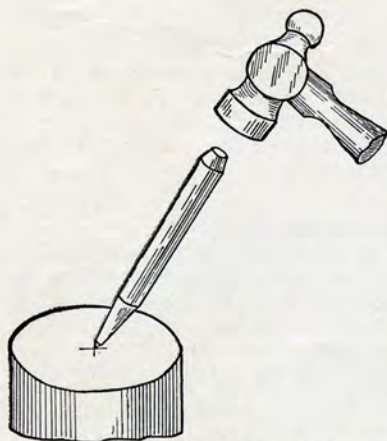


Fig. 449.—Changing Position of the Center Point

Changing the Position of Center Point

Place the work again in the vise and drive the center punch mark in the proper direction necessary to have the work run true. Complete this operation on both ends of the work and place it back on the centers and test again with chalk. When the work is running true on the centers, it is then ready for drilling and countersinking.

Straightening the Work

If the piece to be machined is close to size in the rough so that very little stock is left for machining, care should be taken to see that the bar is straight as possible and that the center holes are located accurately so that the shaft may be true all over when finished.

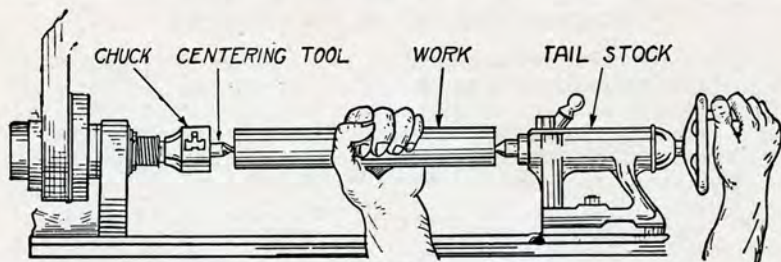


Fig. 450

COUNTERSINKING WORK ON A LATHE

Fig. 450 shows the method of countersinking a short cylindrical shaft on a lathe. We call the shaft the work.

The location of the centers on the work have already been found as indicated in a previous article. A drill chuck is placed in the head stock spindle of the lathe. A combined drill and countersink or centering tool is held in the chuck. The work is placed with the center point on the tail stock center of the lathe and held with the left hand. See Fig. 450 above. The right hand is used to feed the tail stock center and the work to the combined drill and countersink. Start the lathe and feed the work until the countersunk hole enters to the proper depth. Remove the work, place the countersunk hole on the tail spindle center and countersink the other end of the work.

In feeding work to a combined drill and countersink, a drop or two of oil should be used on the drill. The work should be fed slowly and carefully so as not to break the point of the drill. Extreme care is needed when the work is heavy because it is then more difficult to feel the proper feed of the work on the center drill.

The Broken Drill

If while countersinking a hole in the work, the center drill breaks, and part of the broken drill remains in the work, this part must be removed. Sometimes it can be driven out by a chisel or jarred loose, but it may stick so hard that it cannot be removed. In that case the broken part of the drill should be annealed, and the only way to anneal it is to anneal the end of the shaft. After steel is annealed, the broken drill may be drilled out.

TRAINING AND VOCATION

"There is a tremendous waste in the world due to the fact that many of the workers have not found the vocation for which they are adapted and are not trained in the work they are doing."—HARRIS.

Young man, give some thought to the above statement, try to find the vocation for which you are adapted and become trained in that line of work.

COUNTERSINKING CENTER HOLES

For countersinking a piece of work the combined drill and countersink is the most practical tool. See Fig. 451.



Fig. 451.—Combined Drill and Countersink

These combined drills and countersinks vary in size and the drill points also vary. Sometimes a drill point on one end will be $\frac{1}{8}$ " in diameter, and the drill point on the opposite end $\frac{3}{16}$ " in diameter. The countersink is always 60 degrees, so that the countersunk hole will fit the angle of the lathe center point which is 60 degrees.

Countersinking Center Holes with a Small Twist Drill and Special Countersink

If a combined drill and countersink is not available, the work may be centered with a small twist drill. Let the drill enter the work a sufficient length on each end, then follow with a special countersink, the point of which is 60 degrees.

Below we show two countersinks that can be made in a very short time, either one of which will do satisfactory work.



Fig. 452.—Special Countersink



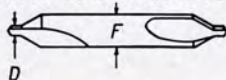
Fig. 453.—Special Countersink

Size of the Countersunk Center Hole

The drawing and tabulation below show the correct size of the countersunk center hole for the diameter of the work. This tabulation also contains the price of the carbon steel combined drill and countersinks.



Combined Drill & Countersink



No. of Comb. Drill & Countersink	Dia. of Work W	Large Diameter of Countersunk Hole C	Dia. of Drill D	Dia. of Body F		
1	$\frac{3}{16}$ " to $\frac{5}{16}$ "	$\frac{1}{8}$ "	$\frac{1}{16}$ "	$\frac{13}{64}$ "		
2	$\frac{3}{8}$ " to 1"	$\frac{3}{16}$ "	$\frac{3}{32}$ "	$\frac{3}{10}$ "		
3	$1\frac{1}{4}$ " to 2"	$\frac{1}{4}$ "	$\frac{1}{8}$ "	$\frac{3}{10}$ "		
4	$2\frac{1}{4}$ " to 4"	$\frac{5}{16}$ "	$\frac{5}{32}$ "	$\frac{7}{16}$ "		

EXAMPLES OF COUNTERSINKING

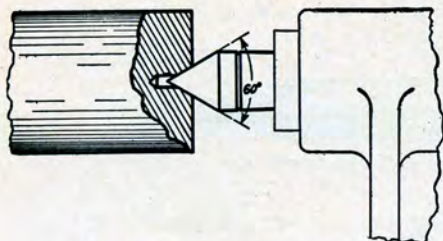


Fig. 454.—Correct Countersinking

Correct Countersinking

Fig. 454 shows the correct form and depth for countersinking work to be machined on centers. Note that the small hole is deep enough so that the point of the Lathe center does not come in contact with the bottom of the hole.

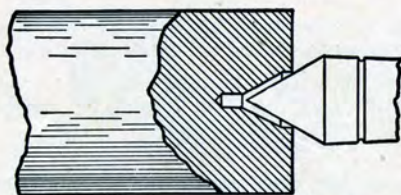


Fig. 455.—Incorrect Countersinking

Incorrect Countersinking

Fig. 455 shows a piece of work in which the countersunk hole is too deep, and that only the outer edge of the work rests on the Lathe center. Accurate work cannot be machined on centers when countersunk in this manner.

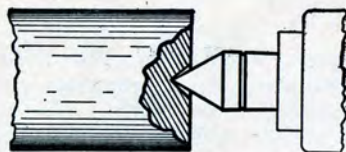


Fig. 456.—Incorrect Taper in the Work

Countersink Not Deep Enough with Incorrect Taper

Fig. 456 shows a piece of work that has been countersunk with a tool of an improper angle. This work rests on the point of the Lathe center only. It is evident that this work will soon destroy the end of the Lathe center and it will be impossible to do an accurate job.

THE COUNTERSUNK HOLE AND THE LATHE CENTER POINT

The importance of proper center holes in the work and a correct angle on the point of the lathe centers cannot be over estimated. In order to do an accurate job between centers on the lathe, the countersunk holes in the work must be the proper size and depth, and the points of the lathe centers must be true and accurate.

LATHE DOGS FOR DRIVING WORK ON CENTERS

To machine a job on centers, it is necessary to mount the work and drive this work by a Lathe Dog. The dogs vary in size for work of different diameters.



Fig. 457.—Common Lathe Dog

Common Lathe Dog

There are three kinds of dogs that are used for this purpose. The most popular is the common lathe dog. See Fig. 457. This dog is used for driving cylindrical pieces, or work having a regular section such as square, hexagon, or octagonal bars.



Fig. 458.—Safety Lathe Dog

Safety Lathe Dog

Fig. 458 is a common lathe dog, similar to the above, but instead of having the head of the set screw exposed, it has a cap over the set screw, and it is called a safety dog.



Fig. 459.—Clamp Lathe Dog

Clamp Lathe Dog

Fig. 459 is called a clamp lathe dog. It is used principally for rectangular work in the lathe.

A Face Plate Driving Stud

Work is sometimes driven between centers by a stud bolt fastened to the face plate. As for example, in driving a pulley on a mandrel, the stud extends far enough from the face plate to reach the spokes of the pulley, and drives in this manner.

MOUNTING LATHE CENTERS IN SPINDLES

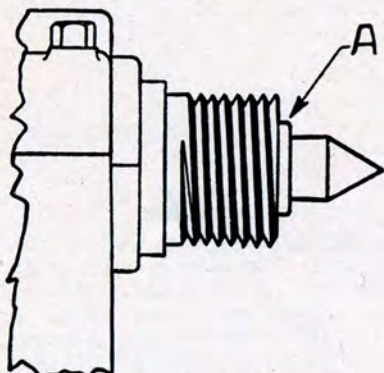


Fig. 460.—Mounting Lathe Centers

To mount lathe centers in the head stock or tail stock spindle of a lathe, thoroughly clean the tapered holes in the spindles. A little dirt left in the spindle or on the long taper of the lathe center will not permit accurate work. Never put your finger in the lathe spindle hole to remove dirt while the head spindle is revolving. Use a stick with a small piece of rag wound around it to clean the spindle hole.

Removing the Head Stock Center

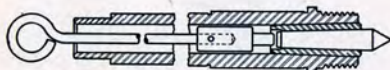


Fig. 461.—Removing the Head Stock Center

To remove the head stock lathe center, insert a $\frac{1}{2}$ " steel rod 30" long through the spindle hole. With a piece of rag in your right hand hold the sharp point of the center, while with the left hand give the rod a

sharp tap and the center will jar loose.

Fig. 461 shows a steel rod with a small bushing attached for removing the head spindle lathe center, also the taper sleeve. The small pin on the point of the bushing will drive the center out. If the sleeve is to be removed, tap with the rod again and the bushing itself will drive it out.

To Remove the Tail Stock Center

To remove the tail stock center turn the hand wheel to the left until the end of the spindle screw bumps the end of the tail center. This will loosen the center and it may be picked out of the spindle.

REMOVING THE LIVE CENTER

Before mounting a chuck on the spindle of the lathe, always remove the live center from the spindle, because if the center is not removed, the operator may forget about it and during a drilling operation he is liable to drill right through the work in the chuck and into the lathe center. When you remove the live center from the spindle, stuff a piece of rag or waste in the spindle hole so it will fit tight, in order to prevent chips and dirt getting into the taper bore of the spindle.

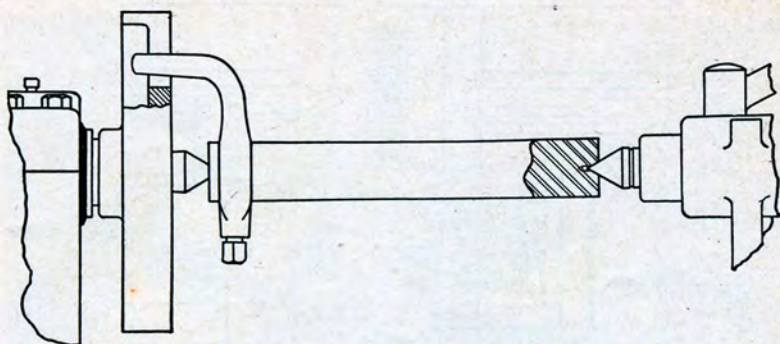


Fig. 462.—An Example of Correct Mounting of Work on Centers

Fig. 462 shows the correct method of mounting the work on centers. The driving dog is attached to the work. The tail of the dog rests in the slot of the face plate and extends beyond the base of the slot, so that the work rests firmly on both the head stock center and the tail stock center.

When mounting work on centers for machining, the tail center should not be tight against the work, but there should be a slight play between the work and the tail center. There should be a supply of oil used on the countersunk hole on which the tail center enters, because the tail center is hardened and tempered, and if the work when revolving is held too tightly by the tail center it will heat the center point and destroy both the center and the work.

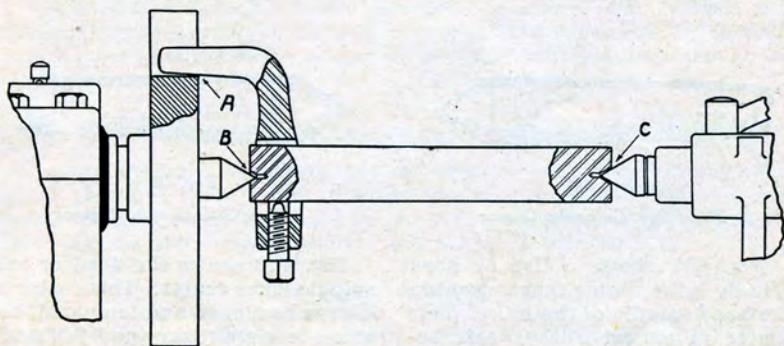


Fig. 463.—Incorrect Mounting

Fig. 463 illustrates an example of incorrect mounting on centers. The dog is fastened on the work, but the tail of the dog rests on the bottom of the slot on the face plate.

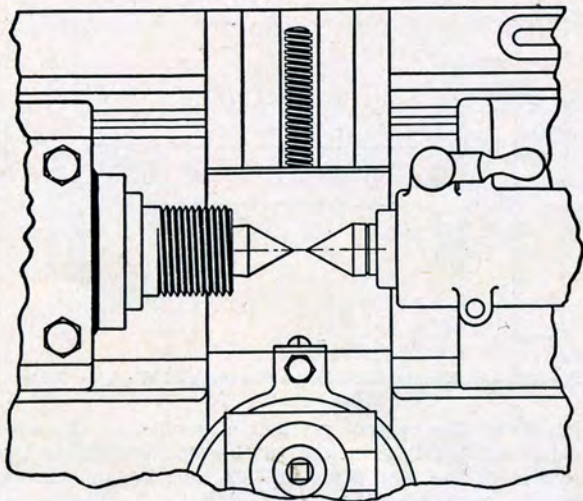


Fig. 464.—Aligning Lathe Centers

HOW TO ALIGN LATHE CENTERS

To align centers, slide the tail stock center up close to the head stock center; clamp the tail stock to the bed and then by moving the hand wheel of the tail stock spindle bring the center point close up to the point of the head stock center. If the tail stock center does not line up adjust the tail stock top in the proper direction and repeat this test and operation until the desired degree of accuracy is obtained. To test the alignment of tail stock centers, see Fig. 472, Page 50.



Fig. 465

Head Spindle Lathe Center



Fig. 466

Tail Spindle Lathe Center

Fig. 465 shows a live or head spindle lathe center that is used in the head spindle of the lathe. This center is almost always soft because it revolves with the work. It should always be kept in good condition; that is, with a sharp point and running true. It is very important that the center runs true.

Fig. 466 shows the dead or tail spindle lathe center. This center is always hardened and tempered, because it is stationary and the work revolves on it. Therefore, there is constant wear on this center.

There is a groove around the hardened or tail stock center to distinguish it from the live or head spindle center.

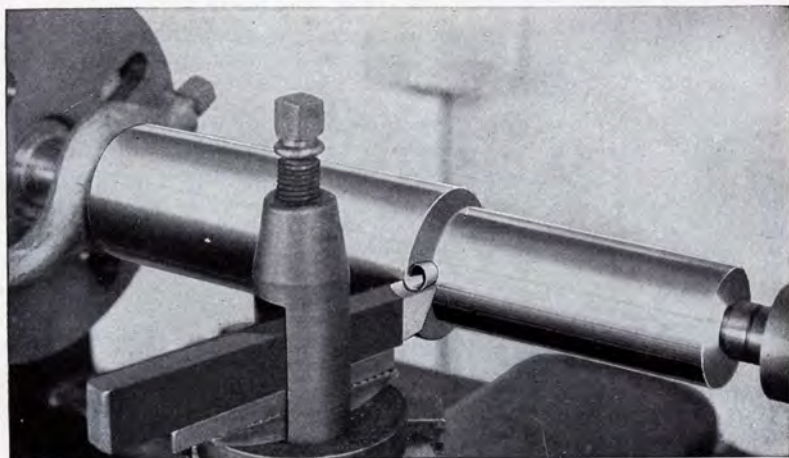


Fig. 467

ROUGH TURNING STEEL AND CAST IRON

Fig. 467 illustrates a lathe in operation taking a heavy cut, which is called rough turning. When a great deal of stock is to be removed from the work, heavy cuts should be taken in order to finish the job in the least possible time.

The proper tool should be selected for taking a heavy chip. The speed of the work, and the amount of feed of the tool should be as great as the tool will stand.

The work should be rough machined to almost the finished size, then care in measuring is required. It is at this point that the operator can demonstrate whether or not he has the ability to become an accurate workman.

CUTTING UNDERNEATH THE SCALE

When taking a roughing cut on steel or cast iron or any other metal that has a scale upon its surface, be sure to set the tool deep enough to get under the scale in the first cut, because unless you do, the scale on the metal will dull the point of the tool.

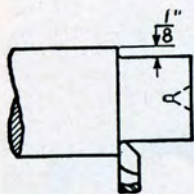
FINISH TURNING

When the work has been rough turned to within about $\frac{1}{32}$ " of the finished size, with a sharp keen tool take a finished cut. Caliper carefully to be sure that you are machining the work to the proper dimension.

On work where it is to be finished by a cylindrical grinder, a limited amount of stock is usually left for grinding to the finished dimensions.

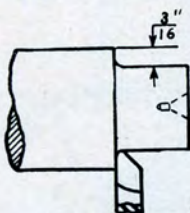
THE DEPTH OF THE ROUGHING CHIP

The drawings below show the depth of a roughing cut on mild steel machined between centers on each size South Bend Lathe.



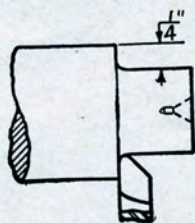
9" Lathe

Reducing the diameter $\frac{1}{4}$ " in one cut.



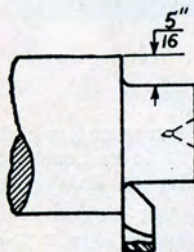
11" Lathe

Reducing the diameter $\frac{3}{8}$ " in one cut.



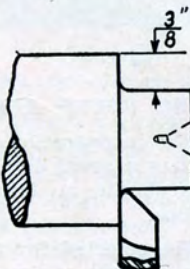
13" Lathe

Reducing the diameter $\frac{1}{2}$ " in one cut.



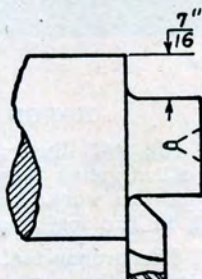
15" Lathe

Reducing the diameter $\frac{5}{8}$ " in one cut.



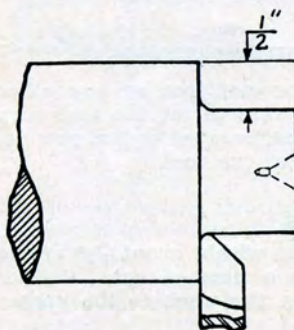
16" Lathe

Reducing the diameter $\frac{3}{4}$ " in one cut.



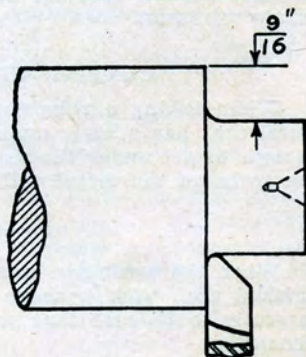
18" Lathe

Reducing the diameter $\frac{7}{8}$ " in one cut.



21" Lathe

Reducing the diameter 1" in one cut.



24" Lathe

Reducing the diameter $1\frac{1}{8}$ " in one cut.

THE CUTTING SPEED FOR DIFFERENT METALS

The following peripheral speed is recommended for cutting metals in the lathe when high speed cutting steel is used. All speeds are based on an average turning feed. F.P.M. indicates the Feet Per Minute periphery speed of the revolving work.

Material	F.P.M.	TURNING AND BORING		Cutting Screw Threads
		Heavy Cut	Finishing Cut	
Cast Iron	60	80	25	
Machine Steel	90	125	35	
Tool Steel, Annealed	50	75	20	
Brass	150	200	50	
Aluminum	200	300	50	
Bronze	90	100	25	

TO FIND THE CUTTING SPEED OF A REVOLVING PIECE OF WORK

To find the cutting speed of the revolving work, multiply the diameter of the work in inches by 3.1416 and multiply the product by the number of revolutions per minute the work rotates, and divide by 12, which will give the periphery speed in feet per minute.

Example: A piece of work 1" in diameter revolving 343.77 revolutions per minute, has a periphery or cutting speed of 90 feet per minute.

$$\frac{1 \times 3.1416 \times 343.77}{12} = 90 \text{ ft. per minute.}$$

NUMBER OF REVOLUTIONS REQUIRED FOR A GIVEN CUTTING SPEED

To find the number of revolutions required for a given cutting speed, in feet per minute, multiply the given cutting speed by 12 and divide the product by the circumference (in inches) of turned part.

Example: Find the number of revolutions per minute for 1" shaft for a cutting speed of 90 feet per minute.

$$\frac{90 \times 12}{3.1416 \times 1} = 343.77 \text{ R. P. M.}$$

SPEED INDICATOR WITH A SURFACE SPEED ATTACHMENT

Fig. 468 shows a speed indicator for determining the speed of revolving shafts in figuring the size of pulleys, etc.

The attachment shown on the speed indicator is pressed against the revolving work and it will indicate on the dial the number of linear feet per minute that the periphery of the work is traveling. This enables the workman to quickly find the proper cutting speed for the work.

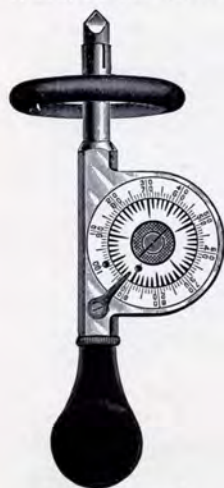
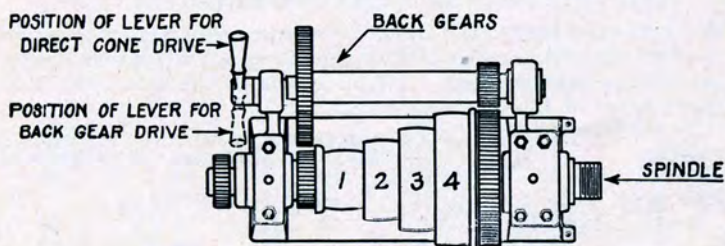


Fig. 468.—Speed Indicator



HEAD STOCK OF A SOUTH BEND LATHE

The drawing above shows the head stock of a lathe, the cone steps are numbered 1, 2, 3, and 4 according to size.

The table below shows the spindle speeds of each size South Bend Lathe when the countershaft is operated at the regular speed as indicated.

SPINDLE SPEEDS OF SOUTH BEND LATHES IN REVOLUTIONS PER MINUTE									
Size of Lathe	Counter-Shaft Speed	Direct Cone Drive				Back Gear Drive			
		1	2	3	4	1	2	3	4
9"	255	595	348	209	—	110	65	39	—
11"	255	510	321	203	—	85	53	34	—
13"	250	607	385	252	162	87	55	36	23
15"	225	579	355	232	142	83	51	33	20
16"	225	598	360	227	141	75	45	28	18
18"	167	375	245	163	145	53	35	23	16
24"	161	400	258	174	114	43	28	19	12
16-24"	150	398	240	152	94	50	30	19	12
36" Brake Drum	150	398	240	152	94	50	30	19	12
42" Brake Drum	125	289	188	126	82	32	20	13	9

If it is required to speed the spindle up for constant machining on copper or wood, where high speed is necessary, a two-speed countershaft can be used or one of the friction pulleys on the countershaft can be driven by a large size pulley on the lineshaft, and any speed desired can be obtained in this way.

FACING A JOB ON CENTERS

When accurate work is to be machined on centers, the first thing to do is to face the ends of the work. Not only to get the ends square and clean, but also to machine the work to the proper length.

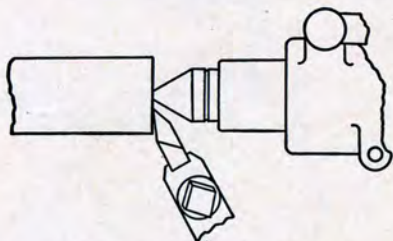


Fig. 469.—Facing a Steel Shaft

dog on the other end of the work and face it to the proper length.

Fig. 469 shows the method of facing a cylindrical piece. The work is placed on centers and driven by a dog. A facing tool bit is then placed in the tool holder and a light cut is taken on the end of the work, feeding the tool from the center towards the outside. One or two chips are then taken, removing sufficient stock to true up the work. Place the

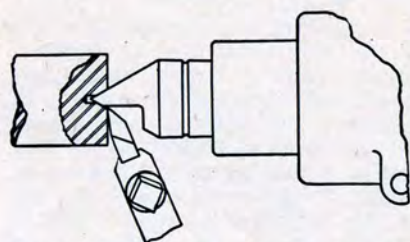


Fig 470.—Facing When Relieved Center Is Used

Facing the Work on a Relieved Center

Fig. 470 shows the method of facing the work when a relieved center is used in the tail spindle. Part of this center has been cut away so that it allows the edge of the tool to face the job from the diameter to the center hole. A relieved center is used when a quantity of small accurate pieces are to be faced.

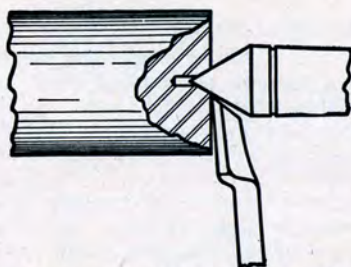


Fig. 471.—Facing with Forged Steel Side Tool

Facing with Forged Steel Side Tool

Fig. 471 shows the method of facing the end of the work by a forged steel side tool. The method of facing is about the same as in the above two examples. That is, the tool may be fed to the outside and also from the outside to the center.

Direction of Feed with a Job on Centers

In machining a job on centers in the lathe, the feed of the tool should always be, when possible, in the direction of the head spindle. The reason is obvious: When the carriage is feeding toward the head spindle and the tool making a heavy chip, the pressure is on the head center which revolves with the work.

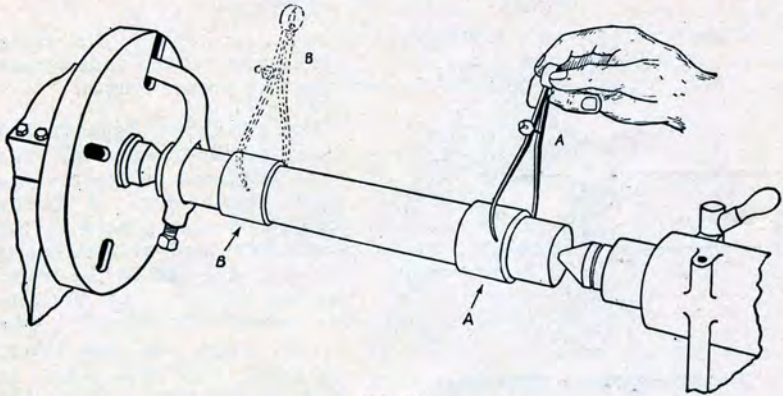


Fig. 472

TESTING THE ALIGNMENT OF CENTERS

Fig. 472 shows the method of testing for the alignment of the Lathe Centers. A steel or cast iron cylinder about $1\frac{1}{2}$ " in diameter has been centered and rough machined. Two collars, A and B, are machined with a fine finished chip without changing the position of the cutting tool. Collar A is calipered, and without making any adjustment on the caliper, collar B is calipered and tested to see how it compares with collar A. If collar A is not the same diameter as collar B, then the alignment of centers is not correct, and the tail stock center should be adjusted in the direction required. This is done by releasing one of the adjusting screws of the tail stock top and setting the opposite screw a similar distance. Then take another test chip on the collars. Continue this operation until the desired degree of accuracy is obtained.

Tail Stock Top and Bottom Mark

There is a mark on the head end of the tail stock where the bottom and top join, which marks the relative position of the tail stock top and bottom when the tail center is in line with the head center. For fine accurate work, this mark should not be depended upon, but the test should be made as above described to be sure that the centers are in line.

If, while making the above test for alignment of centers, it is found that the head center or tail center is blunt or worn, or out of true, then this test is useless, because to do accurate work, lathe centers must not only be aligned properly, but must also be in perfect condition.

Suggestions

In making test for alignment of centers, it is not necessary that the test piece have two collars, as the same test could be made on a straight cylinder, but a test bar like that shown in the above drawing is a very good thing to have around the shop for testing alignment of centers.

See Alignment Tests on Pages 136-138

MACHINING TO A SHOULDER

Machining to a shoulder in production work, where a quantity of pieces are required, is usually started by using the parting tool. The object is to locate the position of the shoulder, and to consider the smaller diameter of the work. The parting tool is inserted about $\frac{3}{8}$ of an inch back of the shoulder line, and enters the work within $\frac{1}{8}$ of an inch of the smaller diameter of the work. Then the stock may be machined by heavy chips. Shouldering eliminates detailed measuring, speeds up production, reduces the cost of machining, and avoids mistakes and spoiled work.

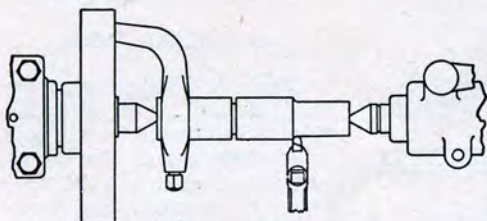


Fig. 473

The Use of the Parting Tool

Fig. 473 illustrates the method of shouldering. A Parting tool has been used, and the turning tool is taking a chip. It will be unnecessary for the operator to waste any time in taking measurements. He can devote his time to rough machining until the necessary stock is removed. Then he can take a finishing cut to accurate measurement.

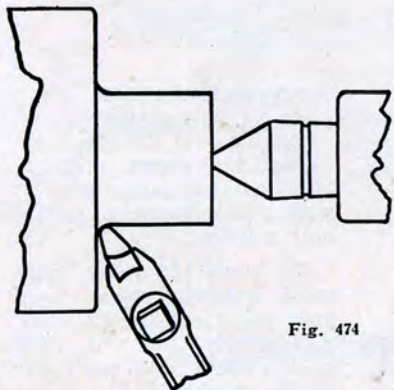


Fig. 474

Facing a Shoulder

Figure 474 shows the application of a finishing of a shouldered job having a fillet corner. A finish cut is taken on the small diameter. The fillet is machined with a light cut, then the tool is used to face from the fillet to the outside diameter of the work.

The Position of the Turning Tool on Heavy Work

Fig. 475 shows the position of the turning tool taking a heavy chip on large work.

The tool should be set so that if anything occurs while machining to change the position of the tool, it will not dig into the work, but rather it will move in the direction of the arrow—away from the work.

Setting the tool in the above position sometimes prevents chatter.

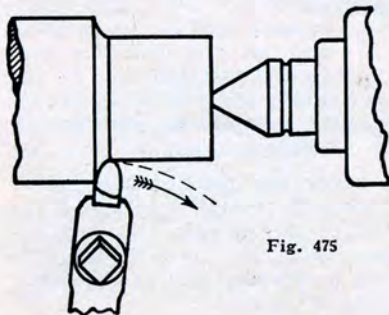


Fig. 475



Fig. 476.—Sample of Knurling

KNURLING IN THE LATHE

Fig. 476 shows three examples of knurling on a piece of steel. The pattern of the knurl is alike in all three cases but of different grades, one is called coarse, another medium, and another fine grade of knurling.

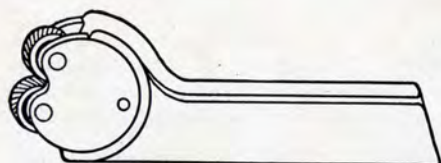


Fig. 477.—Knurling Tool

KNURLING TOOL

Fig. 477 illustrates a form and design of a knurling tool that is used in the tool post of the lathe. The knurling rollers shown in this tool are removable and any grade, fine or coarse, can be substituted to get any grade knurl desired.

KNURLING TOOL IN OPERATION

Fig. 478 shows a knurling tool in operation on work driven between centers on the lathe.

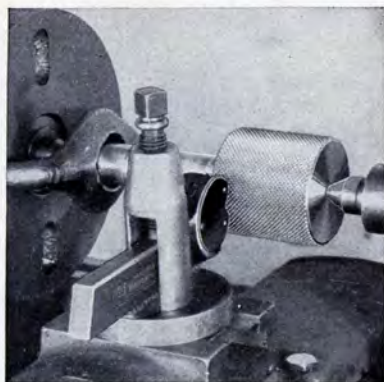


Fig. 478.—Knurling a Steel Piece

To knurl the work, start lathe slowest speed back gear and force the knurling tool slowly into the work at the right end until the knurl reaches a depth of about $\frac{1}{16}$ ". Set the longitudinal feed of the carriage and let the knurling tool feed across the face of the work. Plenty of oil should be used on the work during this operation.

When the left end of the knurl roller has reached the end of the work, reverse the shipper rod. This will reverse the feed of the carriage and the direction of rotation of the spindle. Do not remove the knurling tool from the impression but force it into the work another $\frac{1}{16}$ ", and let it feed back across the face of the work. Repeat this operation until the knurling is finished.

MACHINING WORK ON A MANDREL BETWEEN CENTERS

Cylindrical work that has been bored and reamed in a chuck is usually further machined on a mandrel between centers in the lathe. The mandrel must be driven into the hole of the work tight enough so that the work will not slip on the mandrel while it is being machined on centers in the lathe.

Before driving the mandrel into the hole in the work, with a drop of oil on the finger moisten the fitting part of the mandrel so that after it is driven into the work and the work finished it will be easy to remove the mandrel. If there was no lubricant on the mandrel it might freeze in the work, in which case it cannot be driven out without ruining both the work and the mandrel.

In driving a mandrel out of a piece of work be sure that it is driven in the opposite direction from that which it entered the work.

In the case of special jobs, where no reamers are available, a soft mandrel may be used, turning and filing it to the proper diameter and tapered to make a driving fit for the hole in the work.



Fig. 479.—Steel Lathe Mandrel

The steel lathe mandrels can be purchased in the various standard sizes. These mandrels are hardened and tempered and the surface that receives the work is ground usually to a taper of about .003" from one end of the ground surface to the other. Therefore, these mandrels fitting to the work are driven in, small end of the taper first.

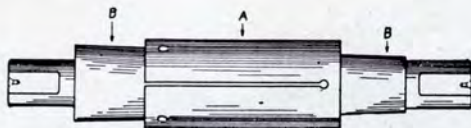


Fig. 480.—An Expanding Mandrel

Fig. 480 shows a practical expanding mandrel. The mandrel itself is machined and has a taper about $\frac{1}{2}$ " to the foot. A taper sleeve having the same internal taper is then fitted to the mandrel. This taper sleeve has a number of slits made by a saw so as to allow an expansion. See illustration.

For using the expanding taper mandrel, imagine you are to machine a pulley. Place the taper sleeve in the hub of the pulley and drive the taper mandrel in the sleeve until it expands the taper sleeve and securely holds the pulley, then place the job between centers on the lathe and start machining.

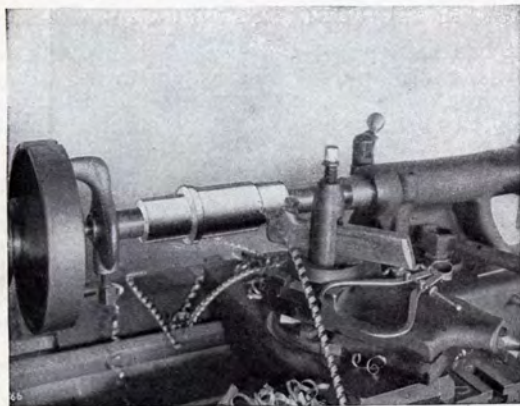


Fig. 481

Fig. 481.—Machining a steel sleeve held on a mandrel and driven between centers.

Fig. 482.—Machining a job on a mandrel between centers, using three cutting tools.

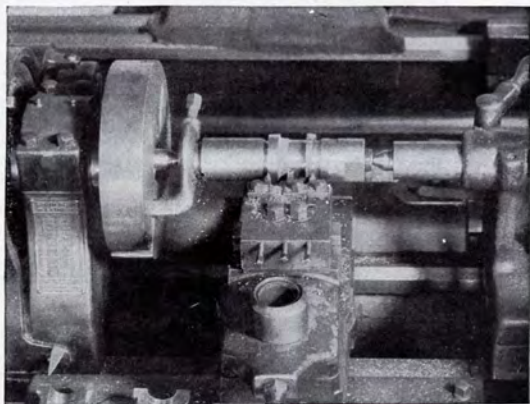


Fig. 482

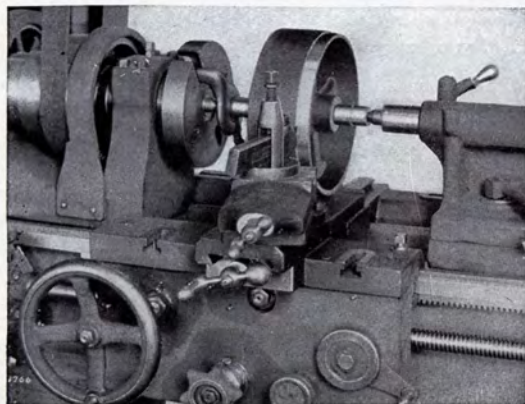


Fig. 483

Fig. 483.—Machining a cast iron pulley held on a mandrel and driven between centers.

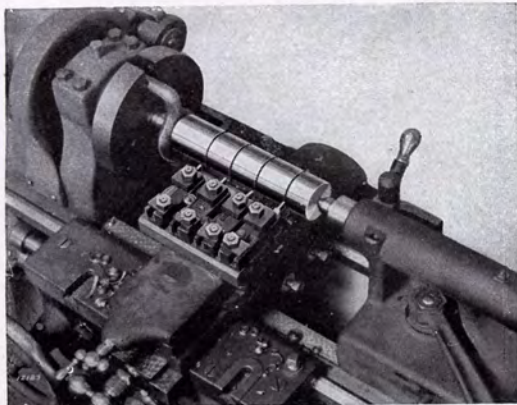


Fig. 484

Fig. 485.—Four turning tools in operation machining four different diameters on a steel spindle.

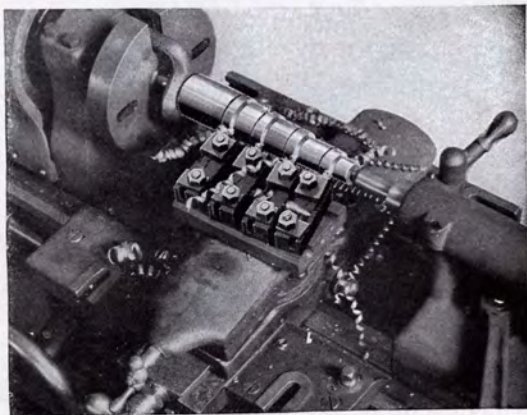


Fig. 485

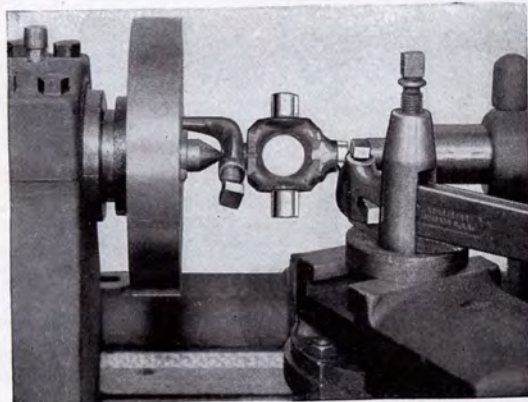


Fig. 486

Fig. 486.—Machining part of a steel knuckle joint, on centers.

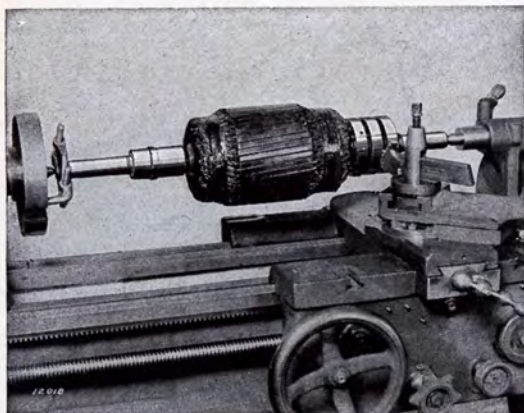


Fig. 487

Fig. 487.—Machining a Slip Ring armature commutator between centers. A direct current armature commutator can be machined in the same way.

Fig. 488.—Two cutting tools in operation on a manufacturing job that is driven on centers in the lathe.

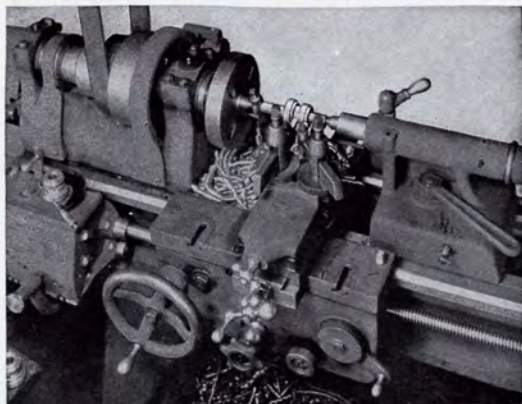


Fig. 488

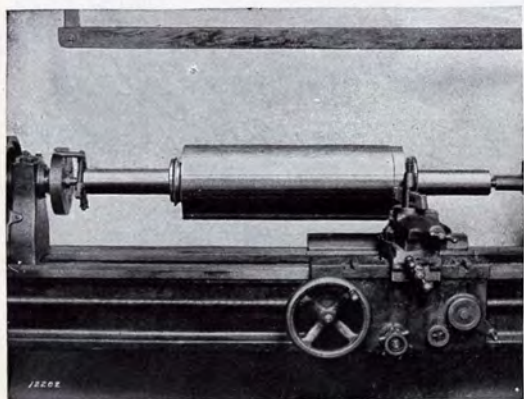


Fig. 489

Fig. 489.—Finishing chip being taken on a printers' roll that is driven between centers on the lathe.

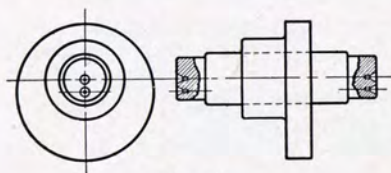


Fig. 490

Fig. 490.—An eccentric cam driven on an arbor with two pair of countersunk center holes, one pair of which is for concentric machining and the other pair for eccentric machining.

Fig. 491.—Machining a crankshaft of a gasoline engine on centers. The cast iron dogs are fastened by set screws to each end of the shaft. These dogs have a pair of countersunk center holes that line up with the throw of the crank.

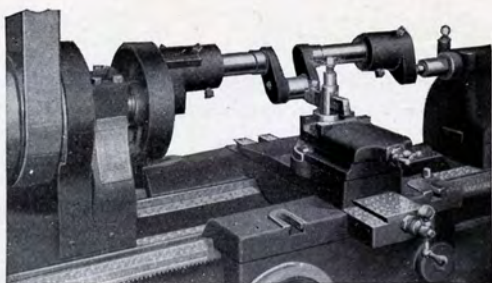


Fig. 491

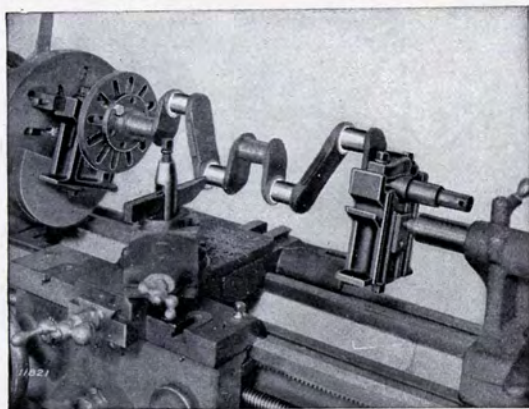


Fig. 492

Fig. 492.—Application of the Norton Adjustable Throw Centers for aligning an automobile crank shaft to machine any of the bearings between centers on the lathe.

THE USE OF A CENTER REST ON THE LATHE

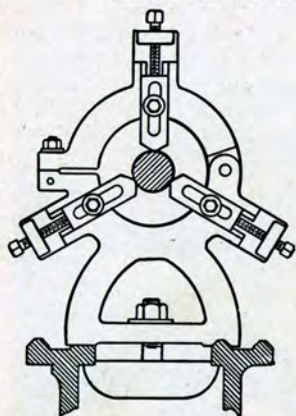


Fig. 493.—The Center Rest on the Lathe

In these jaws. When the work is centered properly, so that it revolves freely, clamp the jaws in position, fasten the work to the head spindle of the lathe, slide the tail stock out of the way and the work is ready for machining.

In turning long shafts of small diameter, and for boring and threading spindles, it is necessary to support the work while it is being machined. This is accomplished by using a center rest.

Fig 493 shows the end view of a center rest that is attached to the lathe bed. The illustration shows a cylinder or shaft being held in the center rest.

MOUNTING WORK IN THE CENTER REST

To mount work in the center rest, place the center rest on the lathe. Place the work between centers, slide the center rest to its proper position, and adjust the jaws upon the work. Careful adjustment is required because the work must revolve

TYING THE WORK TO THE HEAD SPINDLE

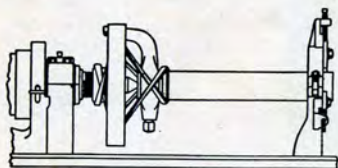


Fig. 494.—Fastening the Work to the Head Spindle

Fig. 494 shows the method of fastening the work to the head spindle. The face plate is unscrewed from the shoulder about three or four turns. Then the work is placed on center and tied securely to the face plate with several heavy belt laces, and finally the face plate is screwed on to the shoulder of the spindle. This tightens the lacing on the work, and holds it firmly.

HOLDING THE WORK IN A CHUCK AND CENTER REST

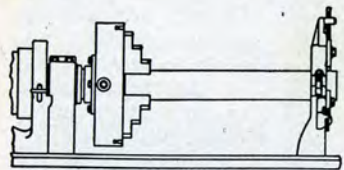


Fig. 495.—The Chuck and the Center Rest

Fig. 495 shows the work, one end being located in the center rest, the other end being held in a 3-jaw Universal Chuck on the spindle of the lathe. For fine accurate work such as turning and boring the taper on spindles for the drill press or the lathe, the chuck should not be used, but the center method used as shown in Fig. 494.

THE FOLLOWER REST ON THE LATHE

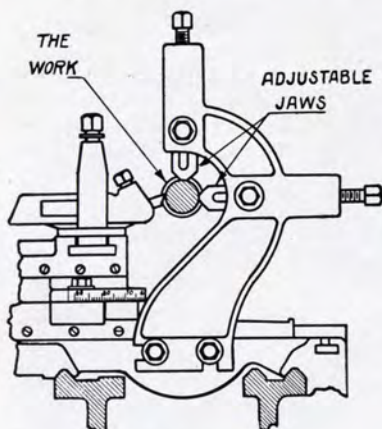


Fig. 496.—The Follower Rest

Fig. 496 shows the application of a follower rest, which is attached to the saddle of the lathe for machining work of small diameter that is liable to spring if it had no support.

The adjustable jaws of the follower rest bear directly on the finished diameter of the work, following the cutting edge of the tool on the opposite side of the work. As the tool feeds along the work, the follower rest being attached to the saddle travels with the tool.

For the machining of small shafts in quantity, small rollers are sometimes substituted for the rigid adjustable jaws and the device is then known as the Roller Bearing Follower Rest.

THE USE OF THE CENTER REST AND THE FOLLOWER REST COMBINED

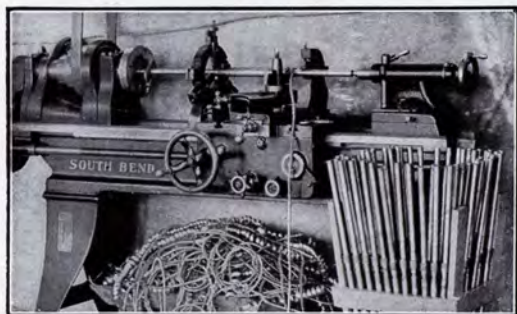


Fig. 497.—Center Rest and Follower Rest on a Job

Fig. 497 shows the application of both the center rest and follower rest on a job at the same time. The spindles or shafts to be machined, while very small in diameter, are of considerable length, and in order to do a good job, it is necessary to support the shaft with both the center rest and follower rest.

This is the method of machining the small, delicate spindles used in textile mills.

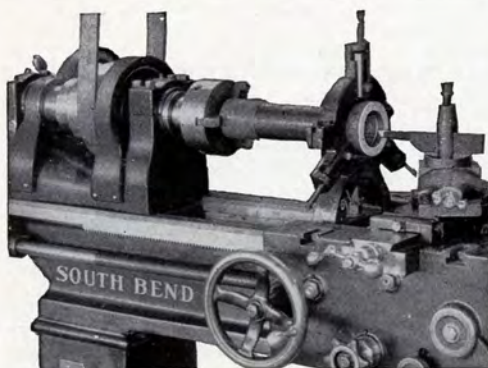


Fig. 498

Fig. 498.—Cutting an internal screw thread in a cylinder, one end of which is held in the center rest, the other end held in a 3-Jaw Universal Chuck on the head spindle.

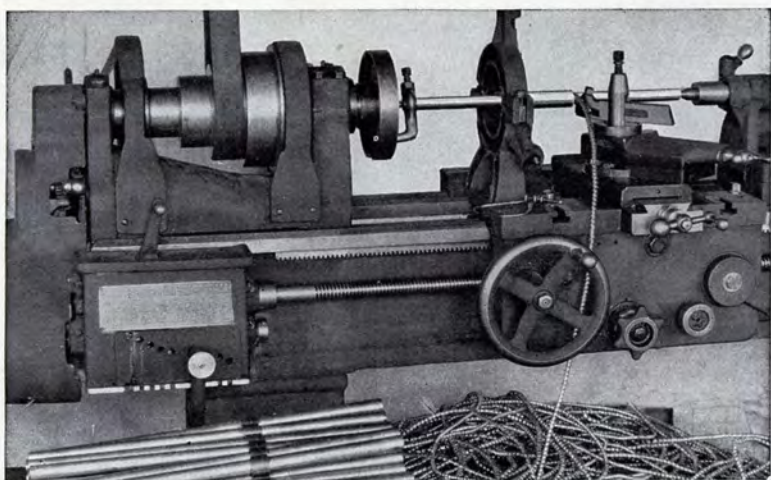


Fig. 499

Fig. 499.—The application of a Center Rest on machining small, slender shafts between centers on the lathe.

Fig. 500.—The application of the follower rest supporting long, slender Acme Thread Screw, while the thread of the screw is being chased by the tool.



Fig. 500

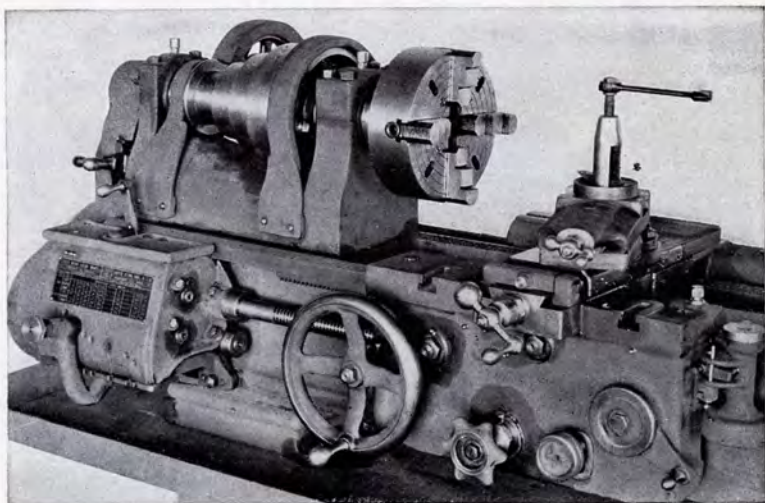


Fig. 501

MACHINING IN THE CHUCK ON THE LATHE

Chucking in the lathe is a very important part of lathe work, especially for general work in the machine shop.

Fig. 501 shows a 4-jaw Independent Lathe Chuck mounted on the spindle nose of the lathe. The most important types of lathe chucks are the Independent Lathe Chuck and the Universal Geared Scroll Chuck.

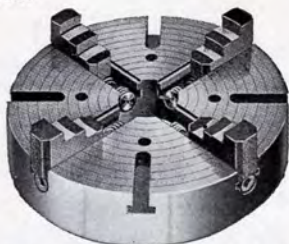


Fig. 502.—4-Jaw Independent Lathe Chuck

Four-Jaw Independent Lathe Chuck

Fig. 502.—The 4-jaw Independent Lathe Chuck is the most practical for general work in the machine shop. The jaws are made of steel, hardened and ground. They are reversible and are readily adjusted to hold work square or round and of various shapes. The jaws are adjusted one at a time.

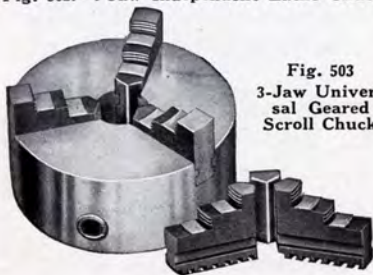


Fig. 503
3-Jaw Universal
Geared
Scroll Chuck

Three-Jaw Universal Geared Scroll Chuck

Fig. 503.—The 3-jaw Universal Geared Scroll Chuck is intended for holding round work. The jaws operate universally and center the work. This chuck is usually fitted with two sets of jaws, both of which are shown in the illustration.

THE PRACTICAL TYPE OF CHUCK FOR THE LATHE

If the lathe is to have but one lathe chuck, it should be a 4-jaw Independent chuck, because it will hold work both rectangular and round, and various other shapes.

If the lathe is to be fitted with two chucks, then the Universal Geared Scroll Chuck should be used in addition to the Independent Chuck, because this enables the operator to handle a great deal of round work without time being spent for continually truing up the work, as the Universal Chuck is self centering.

THE SIZE OF THE LATHE CHUCK

The 4-jaw Independent Chuck should be as large as the lathe will swing with the chuck jaws extended beyond the body. The size of the Universal Chuck should be much smaller, as it is for holding round work, and great capacity is not needed. In the tabulation we show the approximate size chuck, both the Universal and Independent, for each size lathe. The tabulation has been based on chucks to meet the requirements for general work in the machine shop.

THE SIZE OF CHUCKS FOR A LATHE

Size of Lathe	4-Jaw Independent Lathe Chuck		3-Jaw Universal Geared Scroll Chuck	
	Recommended	Maximum	Recommended	Maximum
9 in. lathe.....	6 in.	6 in.	4 in.	6 in.
11 in. lathe.....	6 in.	8 in.	5 in.	7½ in.
13 in. lathe.....	7½ in.	10 in.	6 in.	9 in.
15 in. lathe.....	9 in.	12 in.	7½ in.	10½ in.
16 in. lathe.....	10 in.	12 in.	9 in.	10½ in.
18 in. lathe.....	12 in.	14 in.	10½ in.	12 in.
24 in. lathe.....	16 in.	18 in.	12 in.	18 in.
16-24 in. lathe.....	14 in.	16 in.	9 in.	10½ in.
36 in. lathe.....	14 in.	16 in.	9 in.	10½ in.
42 in. lathe.....	16 in.	18 in.	12 in.	18 in.

The chuck manufacturers make chucks so that they can be fitted to any size or make of lathe. Every chuck has a machined recess on its back to accommodate a chuck plate, the flange of which fits the chuck recess and the hub part is threaded to fit the spindle nose of the lathe.

The 4-jaw Independent Lathe Chuck is made in sizes from 4" to 24", but for practical work in the machine shop the popular sizes are from 6" to 18" inclusive, and for the Universal Chuck from 4½" to 12" inclusive.

MISTAKES!

We all make mistakes. When you make a mistake on a piece of work correct and report it as soon as possible. Do not let it get by. People who shrink from letting mistakes be known for fear it will react on them only make matters worse by so doing.

CHUCK PLATE THREADED TO FIT SPINDLE NOSE OF LATHE

Fig. 504.—Semi-Machined Chuck Plate, threaded to fit the spindle nose of the lathe

Fig. 504 shows a cast iron semi-machined chuck plate that has been threaded to fit the spindle nose of the lathe. The chuck plate is not included in the equipment of the lathe. It is not only threaded to fit the spindle nose, but it is also machined on the front and back faces and there is enough stock on the diameter of the flange so that it may be turned down and fitted to the recess in the back of the lathe chuck.



Fig. 505.—Rear view of the Lathe Chuck

Fig. 505 shows machined recess in the back of a lathe chuck.

The machined recess in the back of the chuck is to receive the chuck plate. This machined recess is accurate so that when the chuck is fitted to the lathe it will run true. The small holes shown in the recess of the chuck are for bolting the chuck plate to the chuck.

For machining chuck plate, see page 64.



Fig. 506.—Chuck with Chuck Plate attached

DRILLING HOLES IN THE CHUCK PLATE TO RECEIVE THE BOLTS

Chalk the face of the flange of the chuck plate. Then place it in the recess of the chuck. When it is bottomed, make a prick punch position mark on the edge of the chuck plate and a corresponding mark on the chuck. Then with a hammer tap slightly the chuck plate so that the edge of the bolt holes on the recess of the chuck will make an impression on the chalk surface of the plate. Lay out and drill the holes in the plate $\frac{1}{16}$ " larger than the diameter of the bolt.

MACHINING A CAST IRON CHUCK PLATE

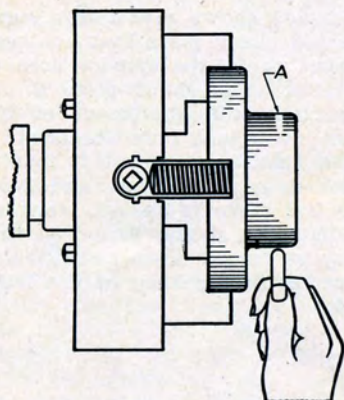


Fig. 507.—Truing a rough casting of a Chuck Plate

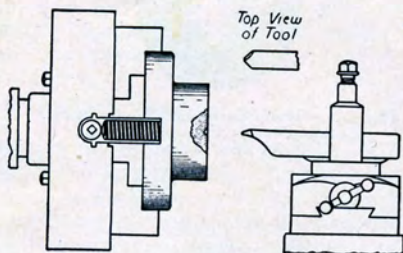


Fig. 508.—Centering a Chuck Plate

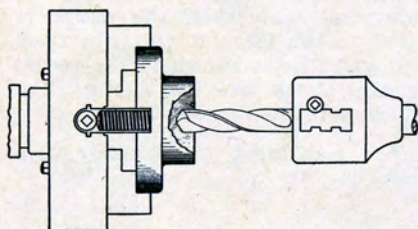


Fig. 509.—Drilling a Chuck Plate

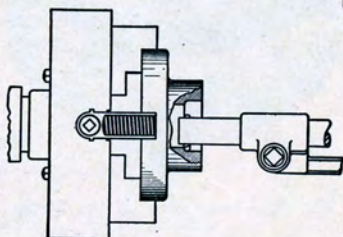


Fig. 510.—Boring a Chuck Plate

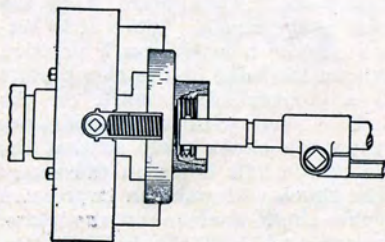


Fig. 511.—Threading a Chuck Plate

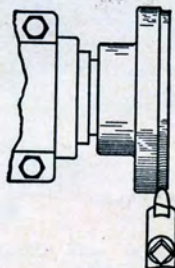


Fig. 512.—Turning the diameter of the flange of the Chuck Plate on the spindle of the lathe

MACHINING THE EDGE OF A CORED HOLE SO THAT DRILL WILL START TRUE

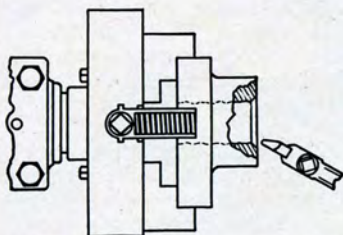


Fig. 513.—Machining the Edge of Cored Hole

Fig. 513 shows an irregular casting being held in a 4-jaw chuck to be machined. The casting has a cored hole which is being beveled with a chamfering tool, which gives it a machined surface that will start a shell drill true.

DRILLING A CASTING HAVING CORED HOLE

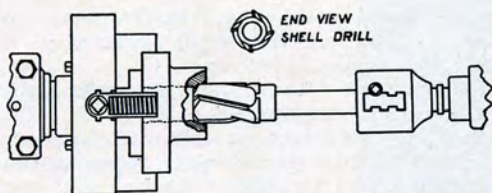


Fig. 514.—Drilling a Cored Hole

Fig. 514.—A shell drill is held in the drill chuck in the tail stock and is fed into the work. The beveled machined surface gives the shell drill an opportunity to center itself and the result is an almost perfect hole.

MACHINING SHORT JOBS IN THE UNIVERSAL CHUCK

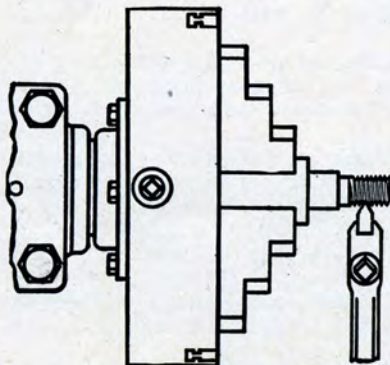


Fig. 515.—Thread Cutting in the Chuck

Fig. 515 illustrates the method of making a small cap screw in the chuck. The drawing shows that the work has been turned, shouldered and threaded. The next operation is the use of a cutting off tool.

A great deal of short work can be done in the chuck in this manner in much quicker time than could possibly be done by centering the work and machining between centers.

MOUNTING WORK IN A FOUR JAW INDEPENDENT LATHE CHUCK

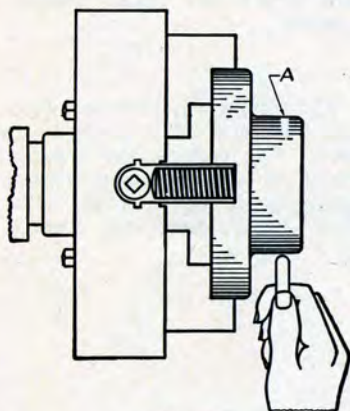


Fig. 516

jaws which are opposite each other. Next tighten jaws No. 2 and No. 4.

3. At this stage the work should not be held in the jaws too tightly, but with just enough grip to hold the work securely so it will not fall out of the chuck while being trued up.

4. Revolve the spindle slowly and with a piece of chalk mark the high spot on the work while it is revolving.

5. Stop the spindle, locate the high spot on the work and adjust the jaws in the proper direction to true the work; releasing the jaw opposite the mark on the work and tightening the one next the mark.

6. Sometimes the high spot on the work shows that an adjustment is needed midway between two jaws. In this case loosen the two jaws, one of each pair, and tighten the opposite jaws.

7. When the work is running true in the chuck, tighten each jaw, one after another in sequence, until all four jaws are clamping the work securely. Be sure that the back of the work rests against the face of the four jaws.

When the work consists of a number of duplicate parts that are to be machined in the chuck, release two adjacent jaws and remove the work. Place another piece in the chuck and tighten the two jaws just released.

Each jaw of a lathe chuck, whether an Independent or a Universal Chuck, has stamped on it a number to correspond with a similar number on the chuck, because each jaw fits only its own screw and slot in the chuck, so that when you remove a chuck jaw for any reason you should always put it back into its proper slot and screw.

When the work to be chucked is frail or light, the jaw should be fastened carefully so that it will not bend, break, or spring the work.

In chucking rings, cylindrical dies, etc., the work can be held from the inside with the jaws pressing outward.

Never leave a chuck wrench in a chuck while the chuck is on the spindle of the lathe.

Fig. 516 shows a rough casting of a chuck plate mounted in a 4-jaw Independent Lathe Chuck on the spindle of the lathe. Before truing the work, determine which part you wish to have run true. To mount this casting in the chuck proceed as follows:

1. Adjust the chuck jaws to receive the casting. Each jaw should be concentric with the ring marks indicated on the face of the chuck. If there are no ring marks, be guided by the circumference of the body of the chuck.

2. Fasten the work in the chuck by turning the adjusting screw on Jaw No. 1 and Jaw No. 3, a pair of

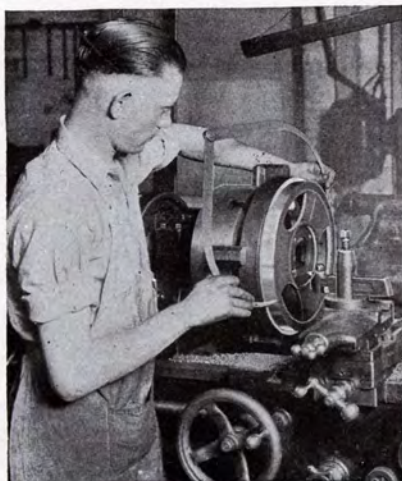


Fig. 526

Fig. 527.—Cutting an internal thread on a cast iron pole base while being held in a 4-Jaw Independent Chuck.

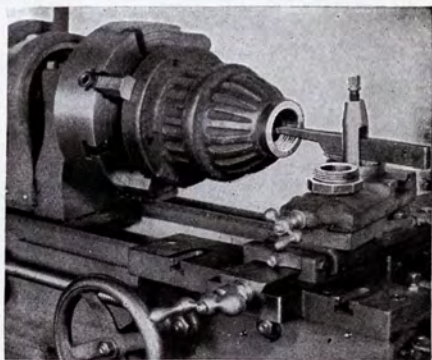


Fig. 527

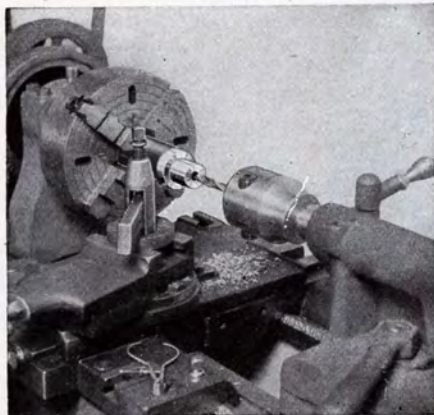


Fig. 528

Fig. 528.—Making a bushing, showing the application of a lathe chuck on the head spindle and the drill chuck on the tail spindle of the lathe.

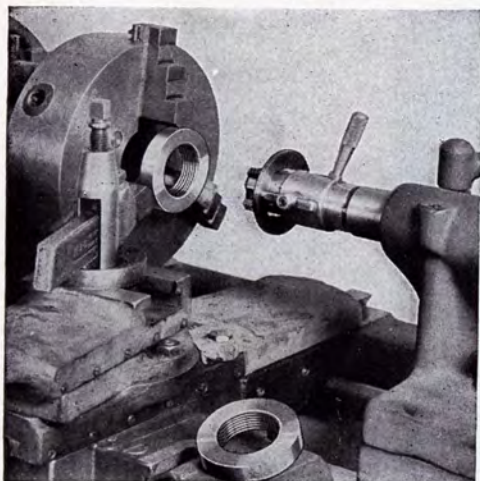


Fig. 529

Fig. 530.—Threading a cap screw. A self opening die head is held in the tail stock spindle which is fed to the work.

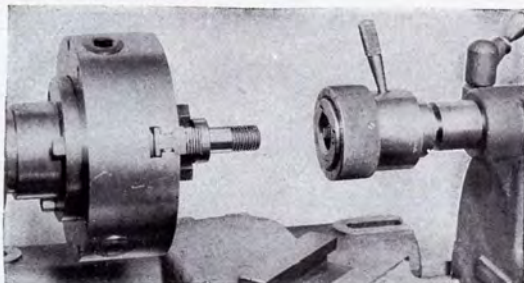


Fig. 530

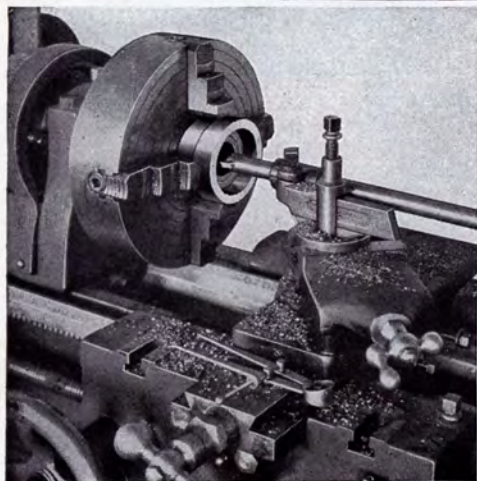
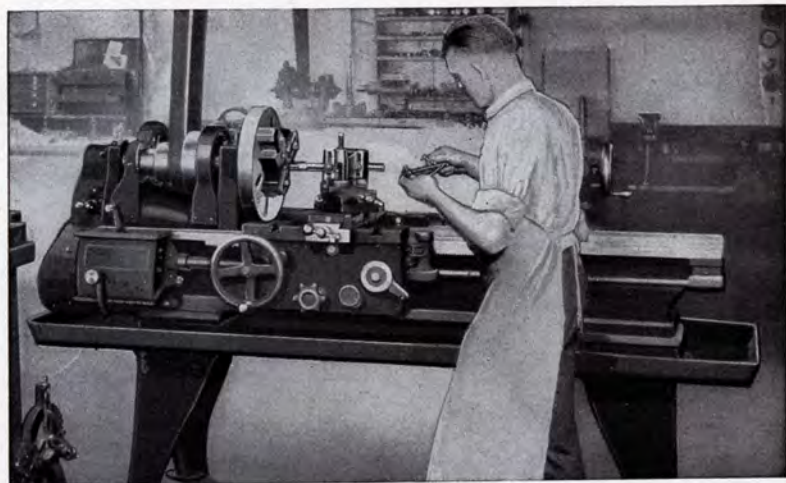


Fig. 531

Fig. 531.—A round piece of work being held in a 4-Jaw Universal Lathe Chuck while being machined.



MACHINING ON THE FACE PLATE

The large face plate of the lathe is designed so that various classes of work may be clamped to it while being machined.

The face plate is especially valuable in tool room work for the laying out and machining of holes in tools and jigs.

These holes must be very accurate, and should not vary more than .001 of an inch in the size of the hole and in the distance between holes.

The face plate is also used for holding jigs for the boring of special work on the lathe and for many other purposes.

MOUNTING A FACE PLATE

Before mounting a face plate on the spindle nose of the lathe, all dirt and chips should be removed from the threaded hole.

Clean the thread on the spindle nose and the shoulder of the spindle, because any dirt on either the tapped hole of the face plate or on the spindle nose will not allow the face plate to run true when it is screwed up to the shoulder.

A few drops of oil on the spindle nose will allow the face plate to screw on easily and be easily removed. If the face plate screws on tightly, unscrew the plate, remove the dirt and try again. The back of the face plate hub should screw tight against the shoulder of the spindle. Do not, however, run the face plate up to the shoulder suddenly as it strains the spindle and the threads and makes removal difficult.

The instructions above, referring to the mounting of the face plate, also apply to the mounting of a lathe chuck on the spindle nose.

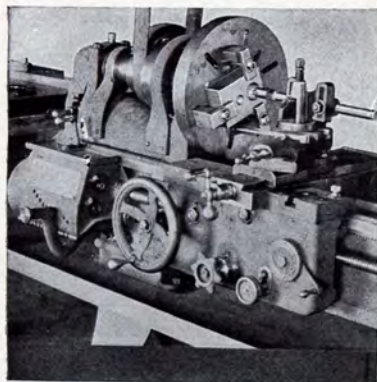


Fig. 532

Fig. 532.—A blanking die clamped to the face plate of the lathe while being machined.

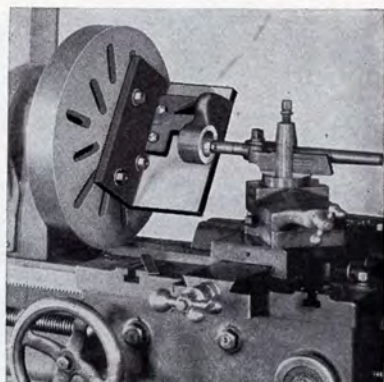


Fig. 533

Fig. 533.—Boring a spindle bracket on an angle iron that is clamped to the face plate of the lathe.

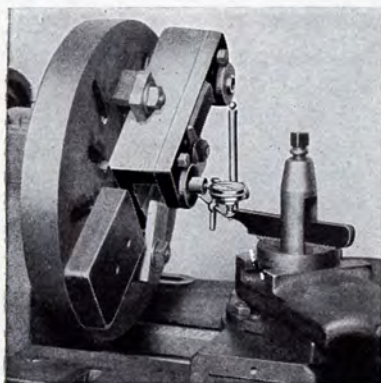


Fig. 534

Fig. 534.—A tool job being trued up by a tool makers' button and a dial test indicator.

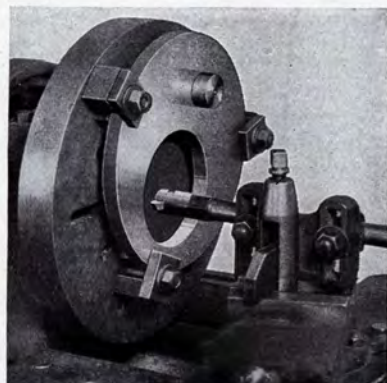


Fig. 535

Fig. 535.—Boring an accurate hole in a steel disc clamped to the face plate of a lathe.

In clamping work to a face plate the surface of the work having been machined, place a piece of paper between the work and the face plate, then clamp, and the danger of work slipping will be very much reduced.

CLEANING THE THREADED HOLE OF A CHUCK OR FACE PLATE

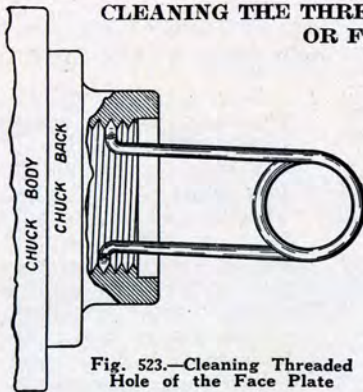


Fig. 523.—Cleaning Threaded Hole of the Face Plate

Fig. 523 shows a simple device made of ordinary brass wire for the cleaning of a threaded hole of a chuck or a face plate before screwing same on the spindle nose of the lathe.

The wire has more or less spring to it so that the device is adjustable and can be used for chucks and face plates of different sizes.

REMOVING A TIGHT FITTING FACE PLATE OR CHUCK FROM THE LATHE SPINDLE

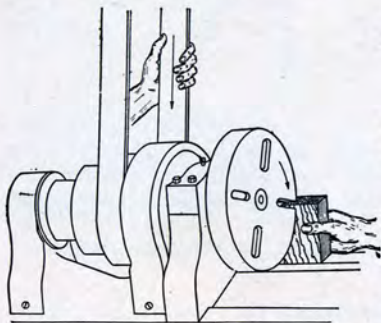


Fig. 524.—Removing Tight Fitting Face Plate from Lathe Spindle

Fig. 524 shows a practical method of removing a tight fitting chuck or face plate from the spindle of the lathe.

Connect the back gear drive; adjust the belt for the slowest speed, set the wood block on the back ways of the lathe; turn the spindle slowly backwards by pulling on the belt. When the slot in the face plate strikes the wood block it will loosen the plate.

THREADING A CHUCK PLATE CLAMPED TO THE FACE PLATE

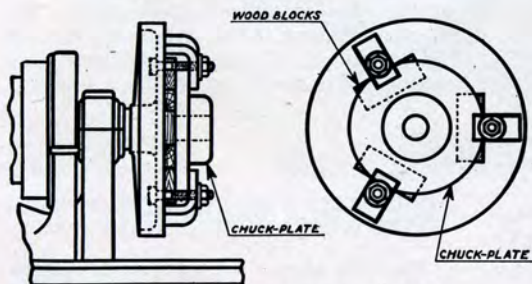


Fig. 525.—Machining a Chuck Plate

Fig. 525 shows a chuck plate casting clamped to the face plate to be bored and threaded to fit spindle nose of the lathe.

This is necessary when the new lathe is the only lathe in the

shop and it is necessary to fit a chuck to this lathe.

In threading a chuck plate in this manner, if you wish to test the thread to see if it is finished, unscrew the face plate without disturbing the chuck plate, and test the work on the spindle nose. If it does not fit and needs another chip, replace the face plate and take the chip.

TESTING INSTRUMENTS FOR CHUCK AND FACE PLATE WORK

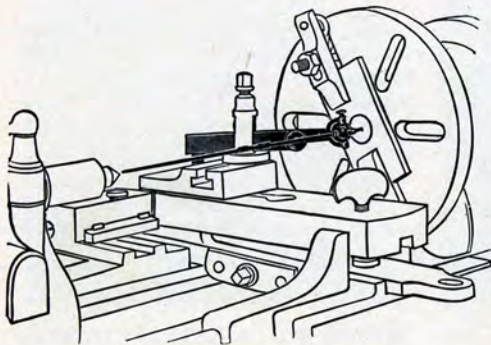


Fig. 517.—Application of Center Tester

Fig. 517 shows the application of a center tester truing a job that has been clamped to the face plate of the lathe. The position of the hole in the work has been laid out and the center has been indicated by a prick punch mark. One end of the center tester bar is placed in the prick punch mark and as the spindle is rotated the outer end of the test rod should run true.

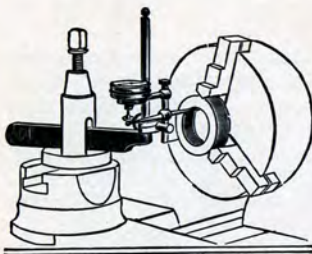


Fig. 518.—Application of a Dial Indicator in Testing Interior Surfaces

Fig. 518 shows the application of a Universal Test Dial Indicator. The indicator is held in the tool post of the lathe. The dial bottom has a small button which rests on the revolving work that is to be tested.

The face of the dial is graduated, reading in thousandths of an inch, and the measuring is done by a small revolving indicator hand. This measuring dial is very sensitive and practical. Its uses are many. For example: testing the alignment of lathe spindles, testing interior of a revolving cylinder, etc. etc.

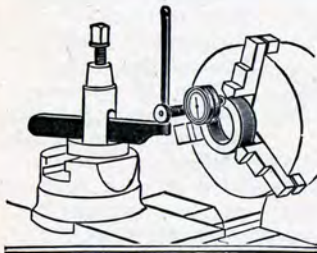


Fig. 519.—Application of a Dial Indicator on End Surfaces

APPLICATION OF THE TEST DIAL INDICATOR ON SURFACE WORK

Fig. 519 shows a Test Dial Indicator testing the face of a revolving piece of work that is held in the chuck. Another use for this dial tester is to place it in the tool post of the lathe and test the face plate while the face plate is revolving, and also testing it while the face plate is at rest by simply feeding across the surface of the plate.

DRILLING, REAMING AND TAPPING IN THE LATHE

Using the Lathe as a Drill Press

The screw cutting lathe is an excellent machine for drilling work and it is used for this class of work in many manufacturing plants.

Drilling in a lathe has the advantage of the drill operating in a horizontal position which has a tendency to clear itself of chips. When the work is revolving and the drill is held stationary, one can also get a true hole.

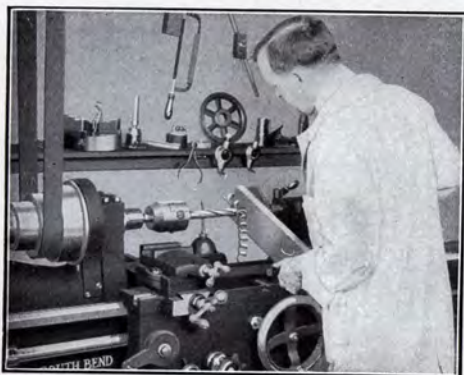


Fig. 619.—Operation of a Drilling Job

Drilling in the Lathe

Fig. 619 shows a drilling operation with a drill chuck in the head spindle. The work being drilled is a steel bar, which is fed to the drill by the hand wheel of the tail stock.

Drill Grinding Gauge



Fig. 620.—Drill Grinding Gauge

Fig. 620 shows a gauge for the grinding of drills. In grinding a drill it is very necessary that the cutting lips be of the same angle and that the angle at the point of the drill be correct.

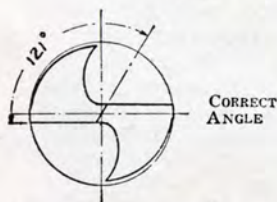


Fig. 621.—Correct Angle of Drill Point

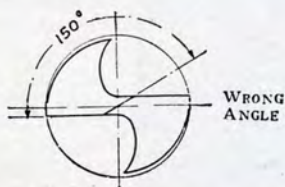


Fig. 622.—Incorrect Angle of Drill Point

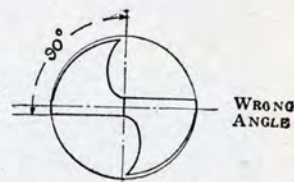


Fig. 623.—Incorrect Angle of Drill Point

REAMING AND TAPPING IN THE LATHE

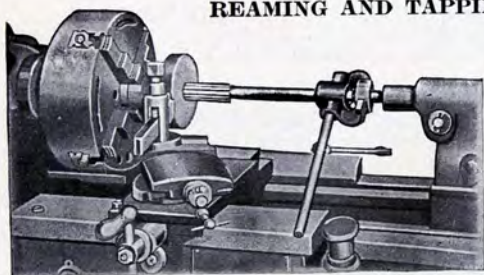


Fig. 624.—Reaming in the Lathe

Fig. 624 shows the application of the machine reamer in the lathe. The reamer is held in a special holder which has a hand lever control.

USING A MACHINE REAMER IN THE LATHE

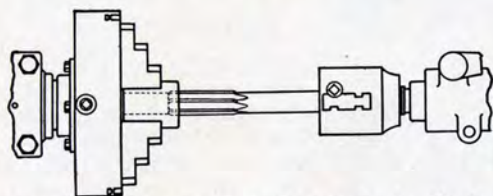


Fig. 625.—Using a Machine Reamer in the Chuck

Fig. 625 shows the application of a lathe chuck holding work and a drill chuck in the tail stock spindle holding a machine reamer. The reamer is fed through the work by the tail stock hand wheel.

TAPPING IN THE LATHE

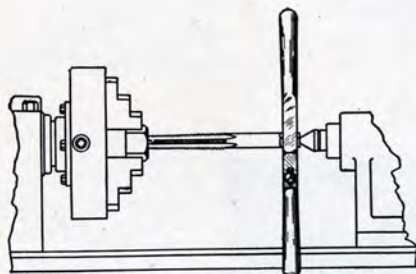


Fig. 626.—Tapping in the Lathe

Fig. 626 shows the tapping of a nut in the lathe. The taper end of the tap is placed in the nut which is held in the lathe chuck. A tap wrench is placed on the tap on the tail center. The spindle is started on slow speed and the tap may be fed in with hand wheel of the tail stock, or for light work the entire tail stock may be pushed by hand.

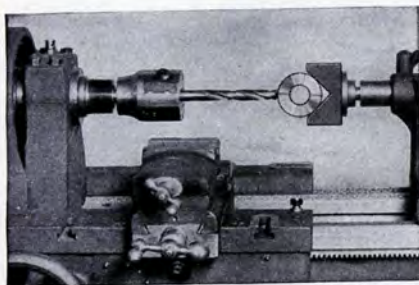
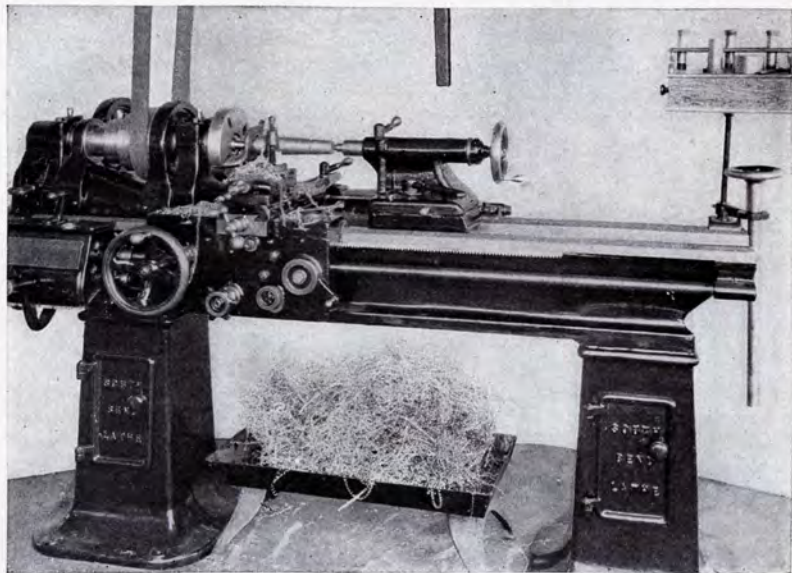


Fig. 627.—Drilling Through the Diameter of a Cylinder

DRILLING THROUGH THE DIAMETER OF A CYLINDER WITH THE AID OF A CROTCH CENTER

Fig. 627 shows the application of a drill chuck in the head stock spindle and a crotch center in the tail spindle, drilling through the diameter of a cylinder or collar.

This is an excellent method of drilling round work.



TAPER TURNING AND TAPER BORING

There are three methods of turning and boring tapers in the lathe: By setting over the tail stock; by using the compound rest; and by using the taper attachment of the lathe.

Turning taper by setting over the tail stock is the most common method used in the machine shop, when the lathe is not equipped with a taper attachment.

The compound rest covers a great variety of taper work, principally for turning and boring tapers for tool and jig work, also for die making, etc.

The taper attachment is used for production work, also where a number of pieces of the same kind are to be turned or bored to a definite taper, and for extreme taper work which cannot be machined by the tail stock set over method.

HEIGHT OF CUTTING EDGE OF THE TOOL FOR TAPER TURNING AND BORING

For the turning and boring of tapers, the cutting edge of the tool should be set exactly at the center of the work. That is, set the point of the cutting edge even with the point of the tail stock or head stock center of the lathe.

The position of the cutting edge of the tool applies to all methods of turning and boring tapers; such as the set over tail stock method; the compound rest and the taper attachment methods.

MORSE TAPERS

Fig. 536 shows the Morse Standard Tapers which are used as the taper in spindles by many manufacturers of lathes and drill presses in the United States. South Bend Lathes have both head and tail stock spindles fitted for Morse Standard Tapers.

MORSE TAPERS

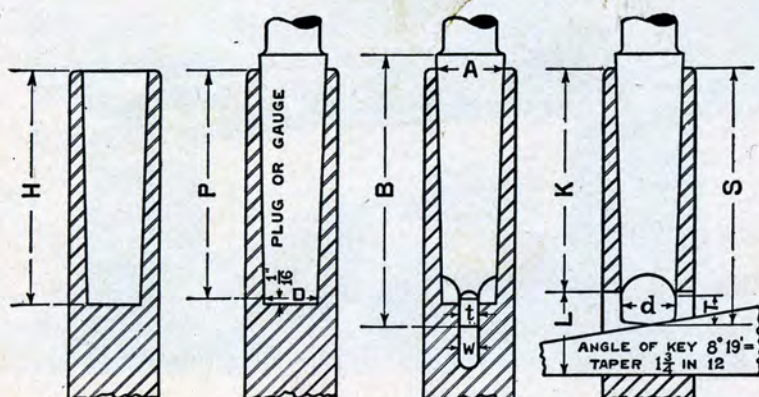


Fig. 536

DETAIL DIMENSIONS

NUMBER OF TAPER		0	1	2	3	4	5	6	7	
DIAM. OF PLUG AT SMALL END		D	.252	.369	.572	.778	1.020	1.475	2.116	2.750
DIAM. AT END OF SOCKET		A	.3561	.475	.700	.938	1.231	1.748	2.494	3.270
SHANK	WHOLE LENGTH OF SHANK	B	2 $\frac{11}{32}$	2 $\frac{9}{16}$	3 $\frac{3}{8}$	3 $\frac{7}{8}$	4 $\frac{7}{8}$	6 $\frac{1}{8}$	8 $\frac{9}{16}$	11 $\frac{1}{8}$
	SHANK DEPTH	S	2 $\frac{7}{32}$	2 $\frac{7}{16}$	2 $\frac{15}{16}$	3 $\frac{11}{16}$	4 $\frac{5}{8}$	5 $\frac{7}{8}$	8 $\frac{1}{4}$	11 $\frac{1}{4}$
DEPTH OF HOLE		H	2 $\frac{1}{32}$	2 $\frac{1}{16}$	2 $\frac{5}{8}$	3 $\frac{1}{2}$	4 $\frac{1}{8}$	5 $\frac{1}{4}$	7 $\frac{3}{8}$	10 $\frac{1}{8}$
STANDARD PLUG DEPTH		P	2	2 $\frac{1}{8}$	2 $\frac{1}{8}$	3 $\frac{3}{16}$	4 $\frac{1}{16}$	5 $\frac{3}{16}$	7 $\frac{1}{4}$	10
TONGUE	THICKNESS OF TONGUE	t	$\frac{5}{32}$	$\frac{13}{64}$	$\frac{1}{4}$	$\frac{5}{16}$	$\frac{15}{32}$	$\frac{5}{8}$	$\frac{3}{4}$	1 $\frac{1}{8}$
	LENGTH OF TONGUE	T	$\frac{1}{4}$	$\frac{3}{8}$	$\frac{7}{16}$	$\frac{9}{16}$	$\frac{5}{8}$	$\frac{3}{4}$	1 $\frac{1}{8}$	1 $\frac{3}{8}$
	DIAMETER OF TONGUE	d	.235	.343	$\frac{17}{32}$	$\frac{23}{32}$	$\frac{31}{32}$	1 $\frac{13}{32}$	2	2 $\frac{5}{8}$
KEYWAY	WIDTH OF KEYWAY	W	.160	.213	.260	.322	.478	.635	.760	1.135
	LENGTH OF KEYWAY	L	$\frac{9}{16}$	2 $\frac{1}{4}$	2 $\frac{7}{8}$	3 $\frac{1}{16}$	4 $\frac{1}{4}$	5 $\frac{1}{2}$	7 $\frac{3}{4}$	10 $\frac{5}{8}$
END OF SOCKET TO KEYWAY		K	1 $\frac{15}{16}$	2 $\frac{1}{16}$	2 $\frac{1}{2}$	3 $\frac{1}{16}$	3 $\frac{7}{8}$	4 $\frac{13}{16}$	7	9 $\frac{1}{2}$
TAPER PER FOOT			.625	.600	.602	.602	.623	.630	.626	.625
TAPER PER INCH			.05208	.05	.05016	.05016	.05191	.0525	.05216	.05208
NUMBER OF KEY			0	1	2	3	4	5	6	7

SOUTH BEND LATHE WORKS

For Brown and Sharpe Tapers, see page 79.

TURNING TAPERS BY SET OVER TAIL STOCK

In straight turning on the lathe, the tail stock top and base are clamped at zero, as shown in Fig. 537, and when the operator has occasion to set over the tail stock for turning taper, he should, when the job is finished, always return the tail stock to zero position for straight turning.

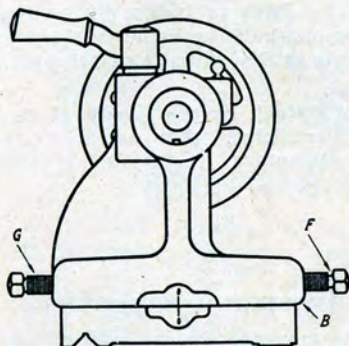


Fig. 537.—Tail Stock on Center for Straight Turning

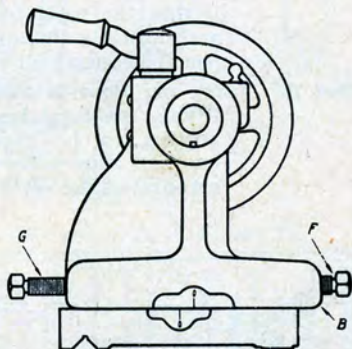


Fig. 538.—Tail Stock Off Center for Taper Turning

For taper turning by the set over tail stock method, the tail stock top is set off of its center position to get the desired angle of the taper. See Fig. 538.

SETTING OVER TAIL STOCK

To set over the tail stock for taper turning, loosen clamping nut of tail stock and back off set screw "G," the distance required, and screw in set screw "F" a like distance until it is tight, then clamp the tail stock to the lathe bed.

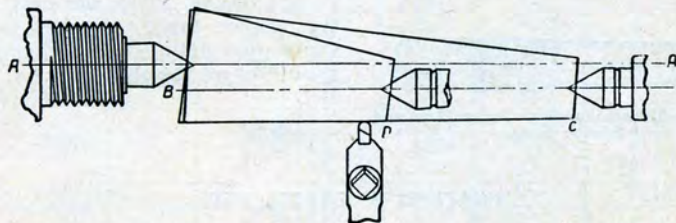


Fig. 539.—Turning Taper with Tail Stock Set Over

In turning taper by setting over the centers, the length of the taper part of the work is important.

In Fig. 539 two pieces of work are shown, one just twice the length of the other, but set over distance of the tail center is exactly the same for both. The difference in taper between the two pieces of work is quite great, therefore the length of the tapered part of the work and the angle of taper must always be considered.

RULES FOR CALCULATING AMOUNT OF TAIL STOCK SET OVER FOR TURNING TAPERS

Case 1. Work to Be Tapered Its Entire Length.

Subtract the diameter of the small end of the taper from the diameter of the large end. Divide the difference by 2; this is the amount of set over required.

Case 2. Taper per Foot Is Specified on the Drawing.

Divide the total length of the stock in inches by twelve and multiply this quotient by one-half the amount of taper per foot specified. The result is the amount of set over.

Case 3. Taper per Foot Is Not Specified.

Divide the total length of the stock by the length of the portion to be tapered and multiply this quotient by one-half the difference in diameters; the result is the amount of the set over.

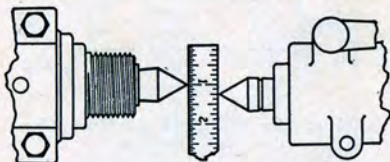


Fig. 540.—Measuring Set Over

MEASURING SET OVER

To measure the set over of tail stock, place a scale between the two centers (see Fig. 540) and this will give you the approximate measure based upon the length of the taper that you desire.

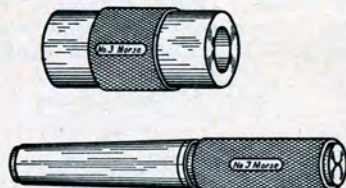


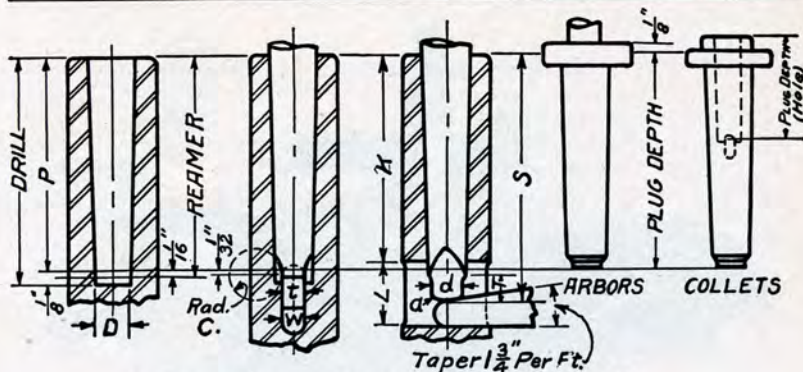
Fig. 541.—Morse Standard Taper Plug and Socket Gauge

MORSE STANDARD TAPER GAUGES

Fig. 541 shows a Morse Standard Taper Plug and a Taper Socket Gauge. They not only give the proper taper, but also show the proper distance that the taper should enter the spindle.

TESTING A TAPER FIT

In testing the taper on a piece of work that is to fit a spindle and is nearly finished, make a chalk mark along the element or side of the taper piece. Place the work in the taper hole it is to fit and turn carefully by hand. Then remove the work and the chalk mark will show where the taper is bearing. If it is a perfect fit, it will indicate along the entire line of the chalk mark. If it is not, it will show where the adjustment is needed. Make the adjustment, take another light chip and test again. Be sure the taper is correct before turning to the finished diameter.



BROWN & SHARPE TAPERS

Taper .500" per ft. except No. 10 which is .5161" per ft.

No. of Taper	Diam. of Plug at Small End D	Plug Depth P			Keyway from End of Spindle K	Shank Depth S	Length of Keyway L	Width of Keyway W	Length of Arbor Tongue T	Diameter of Arbor Tongue d	Thickness of Arbor Tongue t	Radius of Tongue Circle c	Radius of Tongue at a a	Limit of Tongue to project thru Test Tool
		B. & S. Standard	Mill. Mach. Standard	Miscell.										
1	.200"	15/16			15/16	1 3/16	3/8	.135	3/16	.170	1/8	3/16	.030	.003
2	.250"	1 1/16			1 1/16	1 1/2	1/2	.166	1/4	.220	5/32	3/16	.030	.003
3	.312"	1 1/2			1 1/2	1 7/8	3/8	.197	5/16	.282	3/16	3/16	.040	.003
4	.350"		1 1/4		1 3/8	2 3/8	3/8	.197	5/16	.282	3/16	3/16	.040	.003
5	.450"		1 3/4		1 1/2	1 3/2	1/2	.228	11/32	.320	7/32	5/16	.050	.003
6	.500"	2 1/8			1 5/8	2 3/2	3/4	.260	3/8	.420	1/4	5/16	.060	.003
7	.600"	2 7/8			2 1/8	2 7/8	7/8	.291	7/16	.460	9/32	7/16	.060	.005
8	.750"	3 9/16			2 13/16	3 3/2	1 1/8	.322	13/32	.560	5/16	3/8	.070	.005
9	.900"	4 1/2			2 23/32	3 13/16	1 1/8	.322	13/32	.560	5/16	3/8	.070	.005
10	1.0446	5 11/16			3 23/32	4 1/8	1	.353	1/2	.710	11/32	3/8	.080	.005
11	1.250"	5 15/16			3 7/8	4 7/8	1 1/8	.385	5/8	.860	3/4	7/16	.100	.005
12	1.500"	7 1/8			4 3/4	5 3/2	1 5/16	.447	31/32	1.010	7/16	7/16	.110	.005
13	1.750"	7 3/4			5 13/16	6 13/16	1 3/8	.447	31/32	1.010	7/16	7/16	.110	.005
14	2.00"	8 1/2			6 1/2	7 1/2	1 7/8	.447	31/32	1.210	7/16	1/2	.130	.005
15	2.25"	8 3/4			6 3/4	7 3/2	1 7/8	.447	31/32	1.210	7/16	1/2	.130	.005
16	2.50"	9 1/4			6 15/16	7 15/16	1 1/2	.510	1/2	1.460	1/2	1/2	.150	.005
13	1.750"	7 3/4			7 9/16	8 3/16	1 1/2	.510	3/4	1.710	1/2	3/8	.170	.010
14	2.00"	8 1/2	8 1/2		8 3/2	9 3/2	1 1/2	.572	27/32	1.960	9/16	3/4	.190	.010
15	2.25"	8 3/4			8 3/4	9 3/2	1 1/2	.572	27/32	2.210	9/16	3/4	.210	.010
16	2.50"	9 1/4			9	10 1/4	1 3/4	.635	1 1/2	2.450	3/8	1	.230	.010

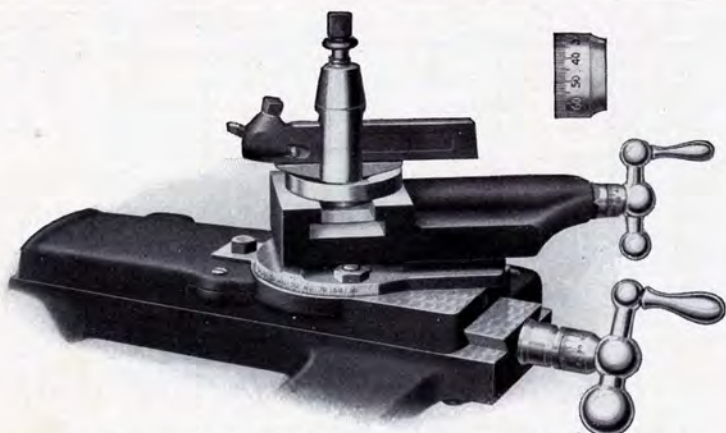


Fig. 543.—Graduated Compound Rest on Saddle of Lathe

THE GRADUATED COMPOUND REST OF A LATHE

The illustration shows the Compound Rest of a Screw Cutting Lathe mounted on the saddle. The base of the Compound Rest is graduated in 180 degrees so that it can be operated at any angle on the horizontal plane.

The Compound Rest Feed Screw and the Cross Feed Screw of the Saddle are both Acme Thread and each has a micrometer graduated collar reading in one-thousandths of an inch for regulating the depth of the cut.

All kinds of straight or taper work such as turning or boring short tapers and bevels, can be done because, in combination the Compound Rest Screw and Cross Feed Screw permit the cutting tool to be fed to the work at any angle for straight or taper machining.

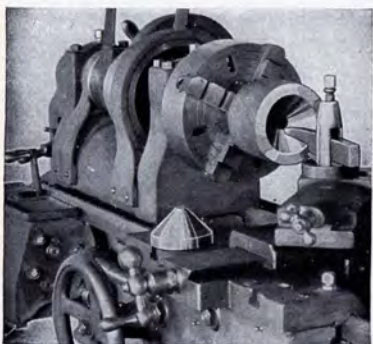


Fig. 544.—Machining a Conical Die in the Lathe, Compound Rest Set at 30 Degree Angle

DUPLICATE TAPER WORK

The compound rest is used very often for duplicating small tapers, as for example in Fig. 544, making a punch and die for forming a sheet metal cone. The die is machined in the chuck, and the desired taper is bored by using the compound rest. Then the punch is machined, and without changing the position of the compound rest, the taper of the punch is turned, which of course is identical with that of the taper of the die.

TRUING A LIVE LATHE CENTER

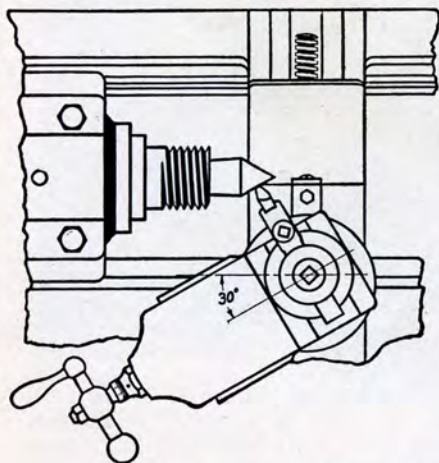


Fig. 545.—Truing a Lathe Center

To machine or true a lathe center, remove the face plate from the spindle. Before truing a lathe center examine the taper hole in the spindle and see that all dirt and chips are removed. Start the lathe, and with a piece of rag on the end of a stick, clean the taper hole thoroughly. Examine the shank of the lathe center and see that no chips are embedded in it and that all dirt is removed. Place the soft center in the spindle firmly, and set the compound rest at an angle of 30 degrees with the axis of the spindle. Place a round nose tool in the tool post. Set the cutting edge of the tool at the exact center point of the lathe center, and machine a chip to the taper

point, an angle of 60 degrees, and test with a center gauge.

TRUING A HARDENED LATHE CENTER

If the hard or tail spindle lathe center is to be trued up, anneal it and machine it in the head stock spindle, following the same operations described for truing a live center; then remove harden and temper and it is ready for use in the tail stock. If an electric tool post grinder is available, the hardened center may be trued up by grinding without annealing.

TESTING THE ANGLE OF A LATHE CENTER POINT WITH A CENTER GAUGE

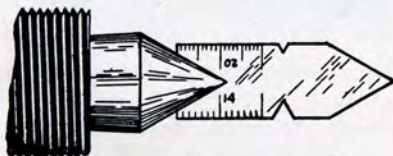


Fig. 546.—Testing Lathe Center Angle

Fig. 546 shows the method of testing the 60 degree angle of a lathe center point with a center gauge. All lathe centers, regardless of size, are finished to an angle of 60 degrees on the point that supports the work.

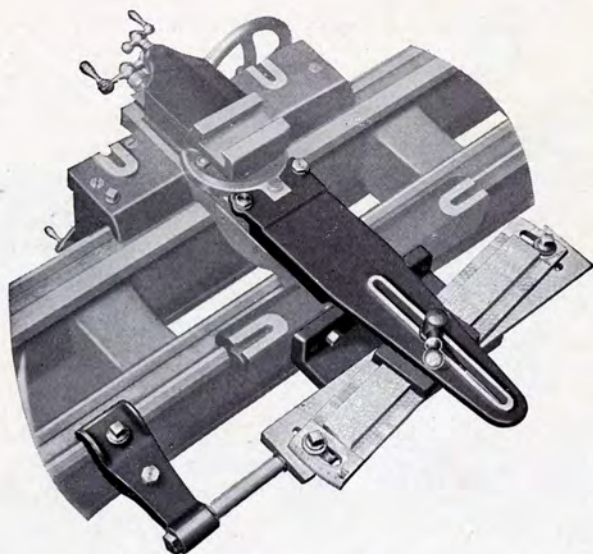


Fig. 547.—Graduated Taper Attachment for the Lathe

A GRADUATED TAPER ATTACHMENT FOR THE LATHE

Fig. 547 is a graduated taper attachment that is fitted to a lathe. The connecting slide is fastened to the tool cross slide. The angle base is secured to the back of the lathe saddle. The table is fastened to the angle base and attached on one end by a bracket clamped on the ways of the lathe. The swivel slide rail is pivoted on the table. This rail is graduated on either end—one end in degrees, and the other end in inches per foot of taper.

When the taper attachment is to be used, remove the screw that holds the cross feed control nut on the saddle and clamp the taper attachment to the ways by setting the square headed screw on the

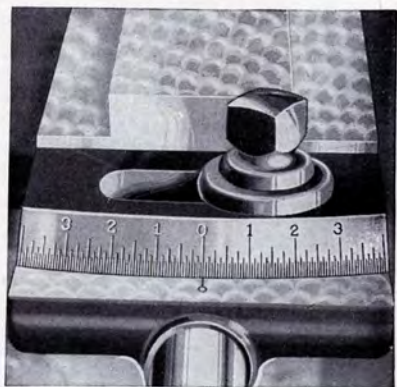


Fig. 548.—Close View of Graduated Taper

clamp, then the taper slide bar controls the feed of the slide rest and the taper attachment is ready for operation.

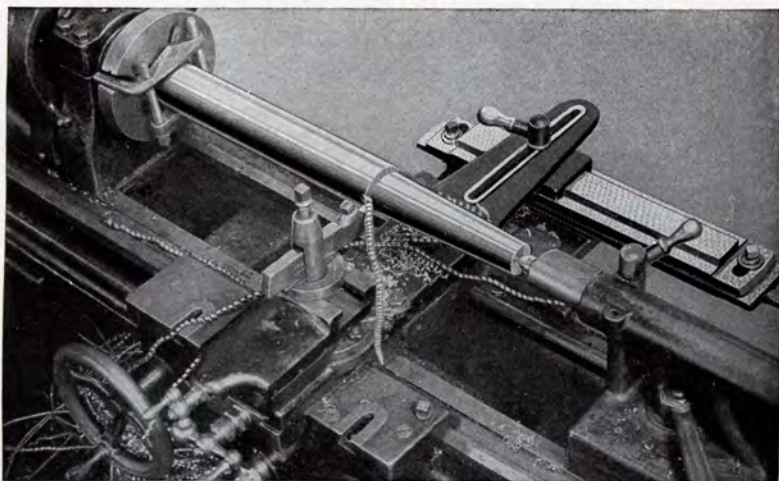


Fig. 549.—Turning with the Taper Attachment

Fig. 549 shows the application of taper attachment on a lathe, turning the taper shank of a spindle for a drill press. The taper is a Morse No. 5 and the job is being done between centers on the lathe.

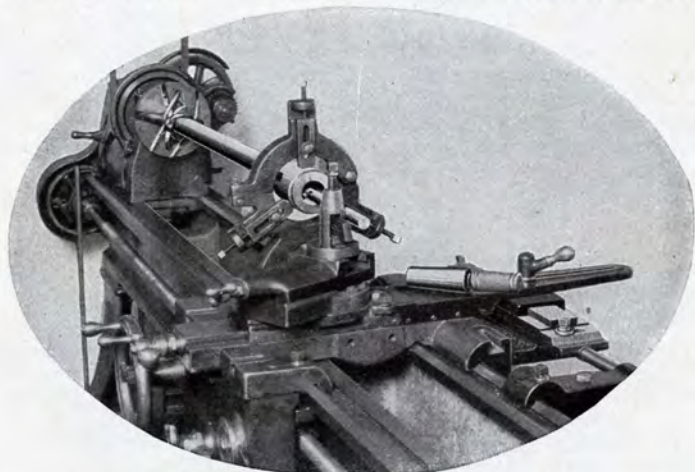


Fig. 550.—Boring with the Taper Attachment

Fig. 550 shows the application of the taper attachment boring a No. 4 Morse taper in a drill press spindle. One end of the spindle is held on the head center, the other end in the center rest.

After the spindle has been bored for the No. 4 Morse taper as illustrated above, it is good practice to stop the lathe and with a No. 4 Morse taper reamer, take a light chip turning the reamer by hand, using a tap wrench for turning. This operation will standardize size of the taper hole.

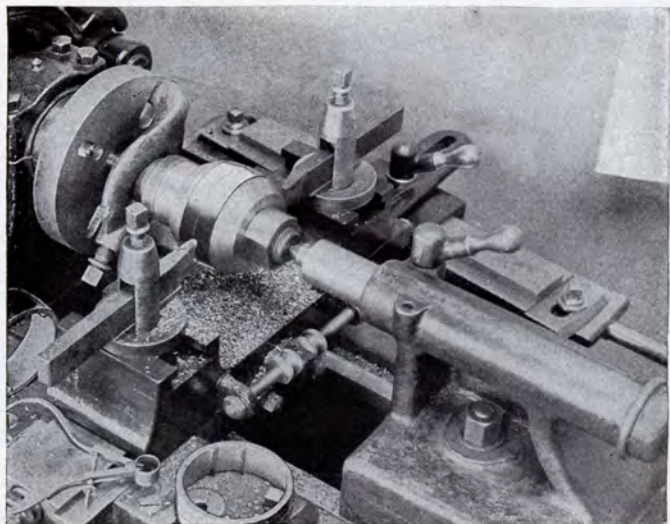


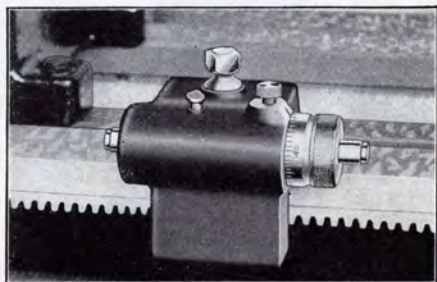
Fig. 551

Fig. 551.—Crowning a cast iron ring held on an arbor using two turning tools, the rear one, which is inverted, machining two different tapers in one operation with the use of the taper attachment. This job can also be done in the same manner with the set-over tail stock method. This job shows the application of two tool rests on the saddle of the lathe.

MICROMETER CARRIAGE STOP FOR LATHE

The **Micrometer Carriage Stop**, shown below, is useful in manufacturing operations and tool room work in accurate facing. It can be used either as a permanent or an adjustable stop. Special means are provided for clamping the Micrometer Carriage Stop to the front "V" of the lathe bed, so that it does not damage the hand-scraped surface.

The **Revolving Barrel** is graduated on one end in thousandths of an inch and knurled on the other so that it can be rotated easily. The adjusting bar or stop is hardened on both ends and is provided with a lock so that the bar can be fastened at any point for duplicate work.



Micrometer Carriage Stop Fitted to Lathe Bed as a Permanent or Adjustable Stop

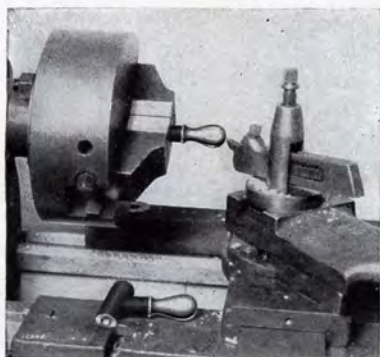


Fig. 638 shows a two jaw lathe chuck fitted to the spindle of the lathe for holding irregular work.

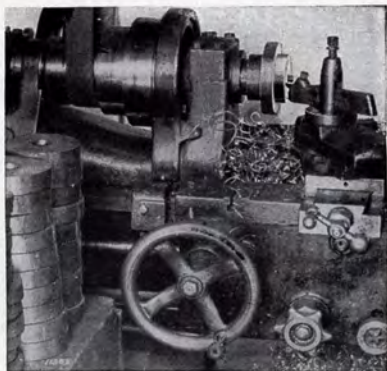


Fig. 639 shows a steel disc held to the face plate of the lathe by a draw-in chuck attachment while being machined.

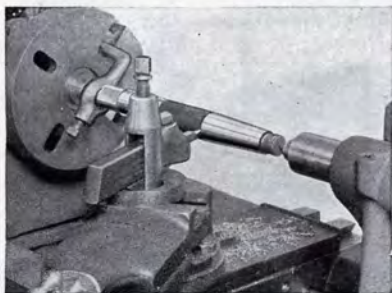


Fig. 552.—Turning taper on a job using the set over tail stock method.

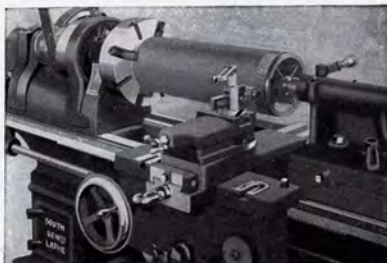


Fig. 641.—Machining a large wrought iron pipe in the lathe showing the application of the pipe centers.

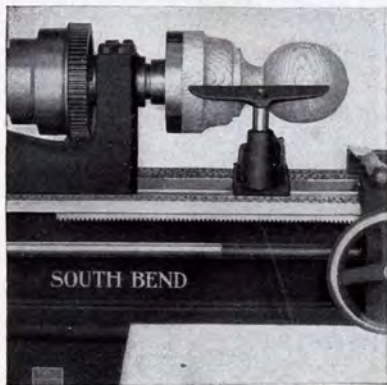


Fig. 642 shows a wood pattern being made on the lathe. The screw cutting lathe can be used for wood turning.

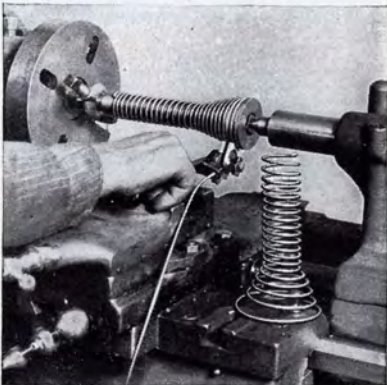


Fig. 643.—Winding a spiral spring on a special shaped arbor held between centers on the lathe.

SCREW THREADS CUT ON THE BACK GEARED LATHE



Master Thread Gauge



Limit Thread Gauge



Cutting a Screw Thread



Acme Thread Tap



"V" Thread Tap



Internal National Coarse Thread



Acme Screw Thread



National Coarse Thread



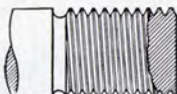
Right Hand Double Screw Square Thread



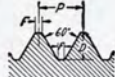
Internal Square Thread



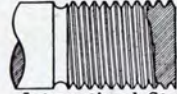
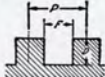
Special Screw Showing Various Types of Threads



National Coarse Screw Thread



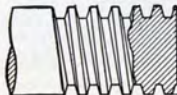
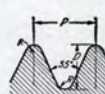
Square Thread



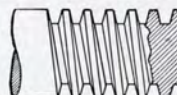
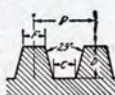
International Standard Metric Screw Thread



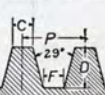
Whitworth Standard Screw Thread



Acme Screw Thread



Brown & Sharpe 29° Worm Thread



Formulas for above will be found on the following pages, 87 to 104.

STANDARD SCREW THREAD PITCHES

The report of the National Screw Thread Commission, applying to screw threads, bolts, machine screws, etc., was prepared in accordance with an Act of Congress and approved June 22, 1928, and defines the following terms:

TERMS RELATING TO SCREW THREADS

Screw Thread. A ridge of uniform section in the form of a helix on the surface of a cylinder or cone.

External and Internal Threads. An external thread is a thread on the outside of a member. Example: A threaded plug. An internal thread is a thread on the inside of a member. Example: A threaded hole.

Major Diameter (formerly known as "outside diameter"). The largest diameter of the thread of the screw or nut. The term "major diameter" replaces the term "outside diameter" as applied to the thread of a screw and also the term "full diameter" as applied to the thread of a nut.

Minor Diameter (formerly known as "core diameter"). The smallest diameter of the thread of the screw or nut. The term "minor diameter" replaces the term "core diameter" as applied to the thread of a screw and also the term "inside diameter" as applied to the thread of a nut.

Pitch Diameter. On a straight screw thread, the diameter of an imaginary cylinder, the surface of which would pass through the threads at such points as to make equal the width of the threads and the width of the spaces cut by the surface of the cylinder.

Pitch. The distance from a point on a screw thread to a corresponding point on the next thread measured parallel to the axis.

Lead. The distance a screw thread advances axially in one turn. On a single-thread screw, the lead and pitch are identical; on a double-thread screw the lead is twice the pitch; on a triple-thread screw, the lead is three times the pitch, etc.

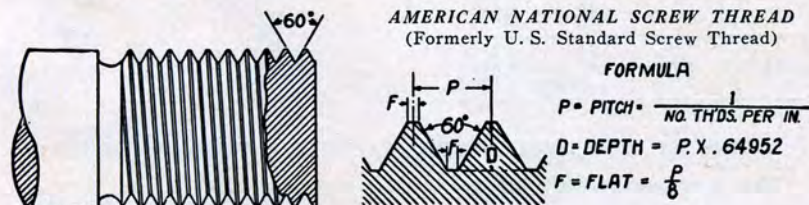


Fig. 553

THE AMERICAN NATIONAL SCREW THREAD

The American National Screw Thread has been approved by the Secretaries of War, Navy and Congress, and is now generally used by all shops in the United States.

TAP DRILL SIZES FOR STANDARD, SPECIAL AND MACHINE SCREW THREADS

The tables on the following page show the American National Coarse Thread Series and the American National Fine Thread Series. The form of the thread is the same for both the fine and coarse series.

The tables show not only the standard number of threads per inch for the diameter of the screw, but also the size of tap drills to use in order that the thread may tap to the proper size. The common fraction drill sizes are given whenever possible, but standard number and letter drills are necessary for some threads.

SIZES OF TAP DRILLS FOR STANDARD AND SPECIAL SCREW THREADS

National Coarse Threads marked with *
National Fine Threads marked with †

All Threads in Table that are not marked are Special Threads

Size of Screw	Threads per Inch	Tap Drill Size	Decimal Equivalent of Drill	Size of Screw	Threads per Inch	Tap Drill Size	Decimal Equivalent of Drill	
¼	20*	7	0.2010	⅝	11*	17	0.5312	
	24	4	0.2090		12	18	0.5469	
	27	3	0.2130		18†	21	0.5781	
	28†	3	0.2130		27	25	0.5937	
	32	3½	0.2187	1½	11*	19	0.5937	
⅕	18*	F	0.2570		16†	20	0.6250	
	20	1½	0.2656	¾	10*	21	0.6562	
	24†	I	0.2720		12	22	0.6719	
	27	J	0.2770		16†	24	0.6875	
	32	⅝	0.2812		27	27	0.7187	
⅜	16*	5	0.3125	1½	10*	23	0.7187	
	20	4½	0.3281		¾	9*	24	0.7656
	24†	Q	0.3320	12		24	0.7969	
	27	R	0.3390	14†		25	0.8125	
				18		26	0.8281	
⅙	14*	U	0.3680	1	8*	27	0.8437	
	20†	2½	0.3906		1½	9*	28	0.8281
	24	X	0.3970			¾	12	28
	27	Y	0.4040		14†		29	0.9219
				18	30		0.9375	
			27	33	0.9687			
½	12	27	0.4219	1	8*	27	0.8750	
	13*	28	0.4219		12	28	0.9219	
	20†	29	0.4531		14†	29	0.9375	
	24	30	0.4531		18	30	0.9687	
	27	31	0.4687	1½	7*	33	0.9844	
⅝	12*	31	0.4844		12†	34	1.0469	
	18†	32	0.5156					
	27	33	0.5312					

SIZES OF TAP DRILLS FOR MACHINE SCREW THREADS

The American (National) Standard Coarse-and-Fine-Thread Series

Coarse Thread Series

Size of Screw	Threads per Inch	Tap Drill Size	Decimal Equivalent of Drill
1	64	53	0.0595
2	56	50	0.0700
3	48	47	0.0785
4	40	43	0.0890
5	40	38	0.1015
6	32	36	0.1065
8	32	29	0.1360
10	24	25	0.1495
12	24	16	0.1770
¼	20	7	0.2010
⅕	18	F	0.2570
⅜	16	5	0.3125
⅝	14	U	0.3680
¾	13	31	0.4219

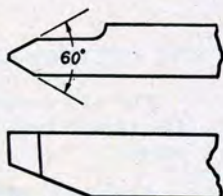
Fine Thread Series

Size of Screw	Threads per Inch	Tap Drill Size	Decimal Equivalent of Drill
0	80	3	0.0469
1	72	53	0.0595
2	64	50	0.0700
3	56	45	0.0820
4	48	42	0.0935
5	44	37	0.1040
6	40	33	0.1130
8	36	29	0.1360
10	32	21	0.1590
12	28	14	0.1820
¼	28	3	0.2130
⅕	24	I	0.2720
⅜	24	Q	0.3320
⅝	20	28	0.3906
¾	20	31	0.4531

National Coarse Thread Series formerly known as U. S. Standard Threads. National Fine Thread Series formerly known as S. A. E. Standard Threads.



Fig. 554.—U. S. Tool Gauge



U. S. STANDARD TOOL GAUGE

Fig. 554 shows the U. S. Standard tool gauge for testing the cutting edge of a thread tool ground to cut the U. S. Standard screw thread.

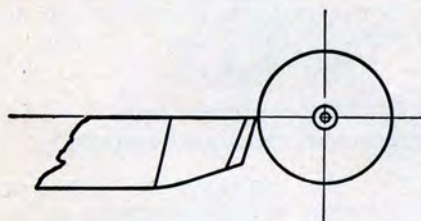


Fig. 555.—Height of Cutting Edge of Tool

HEIGHT OF THE CUTTING EDGE OF THE THREAD TOOL

Fig. 555 shows that the proper height for setting the cutting edge of the thread tool is exactly on the center, which is found by setting the cutting point of the thread tool even with the point of the lathe center.

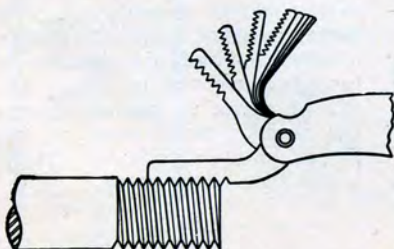


Fig. 556.—Measuring Screw Threads

MEASURING SCREW THREADS

Fig. 556 shows the application of a thread gauge in determining the number of threads to the inch on a bolt or screw. The thread gauge may also be used in determining the number of threads to the inch in a threaded nut.

MEASURING THE THREAD WITH A STEEL SCALE

Fig. 557 shows the method of finding the pitch of the thread when a thread gauge is not available. Place a scale on the screw so that the end of the scale is opposite the top point of any thread; count the number of spaces under the scale between the threads, for a distance of one inch. For example: there are eight spaces underneath the scale in one inch, therefore, the screw is $\frac{1}{8}$ " pitch or eight threads per inch.



Fig. 557.—Measuring Screw Threads

Another method is to place the scale as shown in Fig. 557 and count the top of the threads for a distance of one inch, omitting one thread.

SETTING THREAD TOOL FOR CUTTING EXTERNAL THREADS

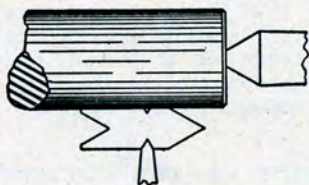


Fig. 558

Fig. 558 shows the method of setting the thread tool for cutting an external thread.

A thread gauge is placed on the point of the thread tool, and the tool is fed forward to the work. The tool should be adjusted so that the edge of the thread gauge is exactly parallel to the work.

SETTING THE TOOL FOR INTERNAL THREAD CUTTING

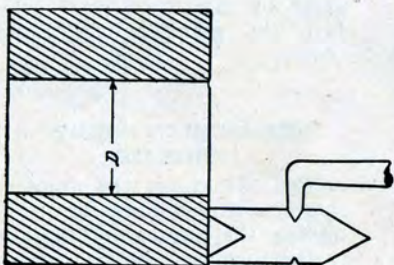


Fig. 559.—Setting Internal Threading Tool

Fig. 559 shows the method of setting a tool for cutting an internal thread on the work.

The tool is fastened in the tool post, a thread gauge is placed against the cutting edge of the tool and the carriage is brought forward so that the thread gauge is resting against the work. Both ends of the thread gauge should be parallel to the face of the work.

HEIGHT OF CUTTING EDGE OF AN INTERNAL THREAD CUTTING TOOL

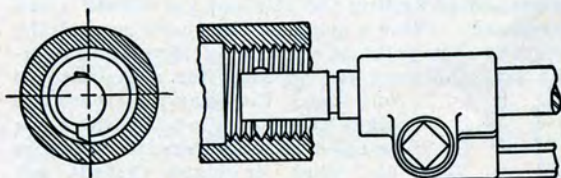


Fig. 560.—Setting Internal Threading Tool

Fig. 560 shows the method of setting a thread cutting tool for internal threads. The cutting edge of the tool is on the center line of the work.

The size of the threading tool for cutting an internal thread is important, because the tool head must be small enough so that it can be backed out of the thread and still leave enough clearance so that it can be drawn from the threaded hole without injuring the thread.

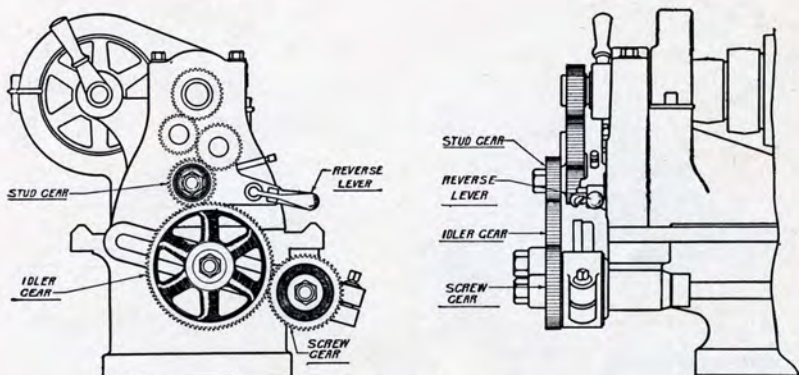


Fig. 561

LATHE SIMPLE GEARED FOR THREAD CUTTING

THREAD	STUD	SCREW
4	64	32
5	64	40
6	64	48
7	64	56
8	32	32
9	64	72
10	32	40
11	32	44
11½	32	46
12	32	48
13	32	52
14	32	56
16	32	64
18	32	72
20	32	80
22	16	44
24	16	48
26	16	52
28	16	56
30	16	60
32	16	64
36	16	72
40	16	80

SOUTH BEND LATHES
SOUTH BEND, IND. U.S.A.

Fig. 562.—Index Plate, 9"–11" Lathe

In Thread Cutting, the work is revolved by the lathe spindle, which in turn is geared to the lead screw. The ratio of the gearing between the spindle speed and the carriage feed determines the pitch of the thread.

A metal index plate is attached to the lathe, showing the necessary gears required to cut Standard Threads. There are three columns of figures on this Index Plate.

Thread Column indicates the number of threads per inch to be cut.

Spindle Column indicates the number of teeth on the stud gear.

Screw Column indicates the number of teeth on the gear that goes on the lead screw.

Example: To gear an 11" Standard Change Gear Lathe for cutting 16 threads per inch. By referring to the Index Plate, 16 threads calls for 32 teeth on the stud gear and a 64 tooth gear on the lead screw.

Connect these two gears by a large idler gear which will mesh.

Compound Rest on an Angle for Cutting Threads

Some mechanics set the compound rest at an angle of 30° in cutting screw threads on a lathe when a quantity of screws are needed, the threading tool cutting only on one side of the thread. This method is satisfactory when the work is done by an experienced mechanic, but is not recommended for the apprentice as it requires skill in grinding and setting the thread cutting tool.

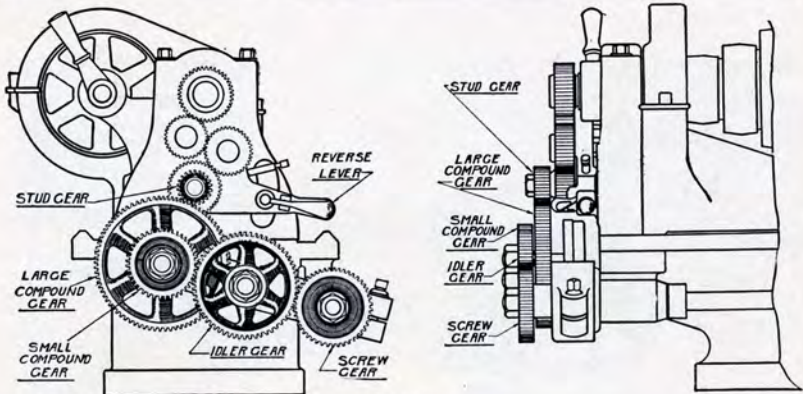


Fig. 563

SOUTH BEND TRADE MARK ENGINE LATHES			
13 - 15 - 16			
THREAD	SPINDLE	SCREW	
2	—	72	24
3	—	48	32
4	—	48	40
5	—	48	48
6	—	48	56
7	—	48	64
8	—	48	72
9	—	48	80
10	—	48	80
11	—	24	44
11 1/2	—	24	48
12	—	24	48
13	—	24	52
14	—	24	56
16	—	24	64
18	—	24	72
20	—	24	80
22	—	24-1-2	44
24	—	24-1-2	48
26	—	24-1-2	52
28	—	24-1-2	56
30	—	24-1-2	60
32	—	24-1-2	64
36	—	24-1-2	72
40	—	24-1-2	80

SOUTH BEND LATHE WORKS
SOUTH BEND, IND., U. S. A.

Fig. 564.—Index Plate, 13", 15" and 16" Lathes

SOUTH BEND TRADE MARK ENGINE LATHES			
18 - 24			
THREAD	SPINDLE	SCREW	
2	—	48	24
3	—	48	36
4	—	48	48
5	—	48	60
6	—	48	72
7	—	48	84
8	—	48	96
9	—	48	108
10	—	48	120
11	—	24	68
11 1/2	—	24	69
12	—	24	72
13	—	24	73
14	—	24	84
18	—	24	96
20	—	24	108
22	—	24-1-2	68
24	—	24-1-2	72
26	—	24-1-2	75
28	—	24-1-2	78
30	—	24-1-2	80
32	—	24-1-2	86
36	—	24-1-2	108
40	—	24-1-2	120

MADE ONLY BY
SOUTH BEND LATHE WORKS
SOUTH BEND, IND., U.S.A.

Fig. 565.—Index Plate, 18", and 24" Lathes

COMPOUND GEARING FOR THREAD CUTTING

Fig. 564 shows Index Plate for the 13", 15" and 16" Standard Change Gear Lathes, geared with compound gears for cutting standard threads.

Compound gears are necessary when cutting fine threads on a lathe fitted with a lead screw having very coarse threads. To cut these fine threads we arrange the gearing in a train of at least four gears, two of which are compound gears.

Fig. 563 shows a 16" Standard Change Gear Lathe fitted with compound gear to cut 32 threads per inch. See Index Plate, Fig. 564.

For cutting 32 threads per inch on a 16" lathe, the stud gear has 24 teeth. The screw gear has 64 teeth. The compound gears are composed of two gears, one having twice the number of teeth as the other one. The smaller compound gear is connected with the screw gear by an idler, and the larger compound gear is connected direct to the stud gear.

Fig. 565 shows an Index Plate for the 18", and 24" Standard Change Gear Lathes. These lathes have a 4 pitch lead screw. Therefore, the gears for cutting the threads vary somewhat from the gears on the 15" and 16" lathes, which have 6 pitch lead screws.

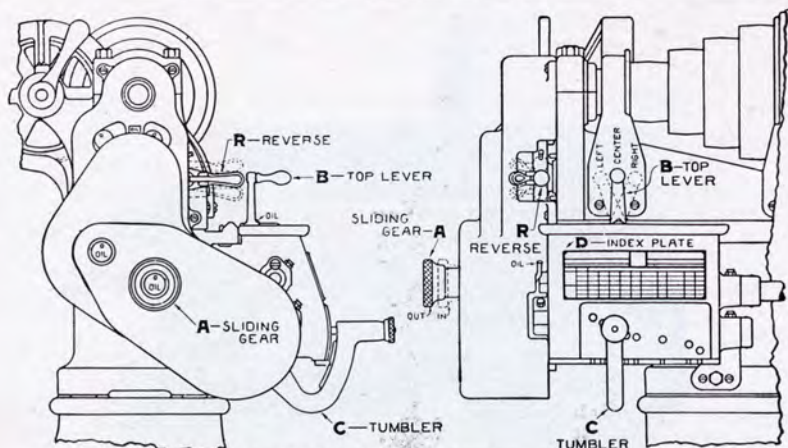


Fig. 566.—Flather Quick Change Gear Box

SOUTH BEND LATHE WORKS		SOUTH BEND, INDIANA, U. S. A.									
PATENT NO 810634.		QUICK CHANGE GEAR									
LONGITUDINAL FEEDS 2 1/4		TIMES THREADS PER INCH									
SLIDING GEAR	TOP LEVER	THREADS PER INCH									
IN	LEFT	2	2 1/4	2 1/2	2 3/4	2 7/8		3		3 1/4	3 1/2
	CENTER	4	4 1/2	5	5 1/2	5 3/4		6		6 1/2	7
	RIGHT	8	9	10	11	11 1/2		12		13	14
OUT	LEFT	16	18	20	22	23		24		26	28
	CENTER	32	36	40	44	46		48		52	56
	RIGHT	64	72	80	88	92		96		104	112

Fig. 567. Index Plate for South Bend Quick Change Gear Lathes for Feeds and Threads

INSTRUCTIONS FOR OPERATING THE GEAR BOX

1. Locate on Index Plate the number of threads per inch you desire to cut.
2. In the first column at the left, see if sliding gear "A" should be in or out and adjust sliding gear to the position indicated. Caution: Sliding gear must not be adjusted while lathe is running.
3. In second column from the left, note the position of top lever "B." Start lathe and shift lever to position indicated.
4. With lathe running, adjust the Tumbler "C" into the hole directly underneath the column in which you found the number of threads you wish to cut.
5. Stop lathe and set reverse bracket into down position. (This will feed carriage towards the headstock.)
6. The gear box is now properly adjusted to cut the desired thread.

Example: To cut 13 threads per inch, locate the figure 13 on the Index Plate. Place sliding gear "A" position in. Top lever "B" position right and Tumbler "C" in the hole directly under the column in which is found the Figure 13, which is the second last column.

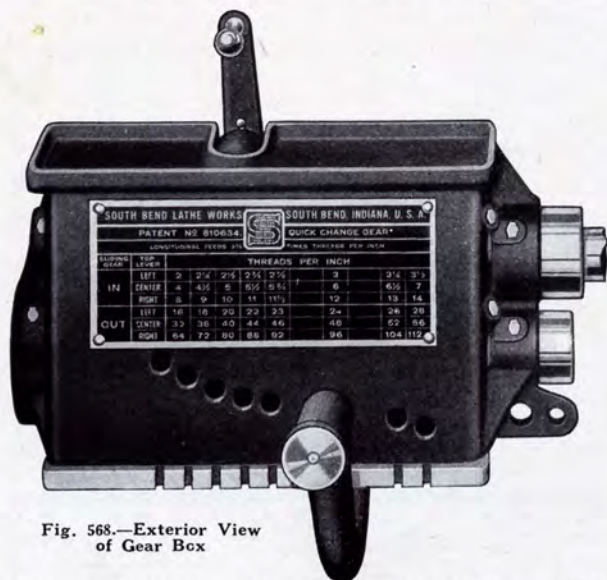


Fig. 568.—Exterior View of Gear Box

QUICK CHANGE GEAR MECHANISM FOR LATHES

The Quick Change Gear mechanism illustrated is the famous Flather Patent. The cone of eight steel gears is mounted upon a shaft, any gear can be instantly engaged by simply moving the lever in front of the box. On another shaft located above the cone of gears is a double clutch gear, controlled by the small lever on top of the box. The moving of this lever to three different positions increases the number of changes obtained by the lower lever to twenty-four, which number is doubled by moving the sliding gear at the end of the lathe making forty-eight in all.

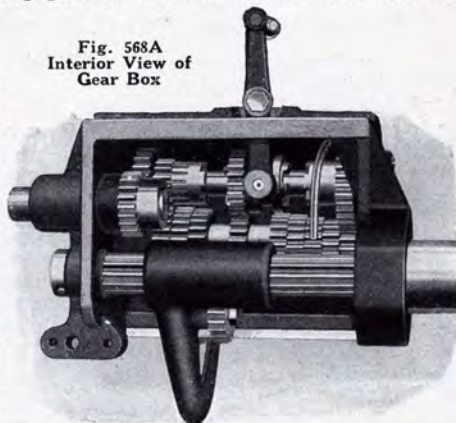
FOR TURNING FEEDS

See drawing on Page 93 which shows gear box set for medium turning feed. This calls for Sliding Gear "A" set out position. Start the lathe and set Top Lever "B" right position. Lathe running, set Tumbler "C" in hole under 96 threads. For finer feed move Tumbler "C" to holes at right. For coarser feed, move Tumbler "C" to holes at the left.

Do not attempt to adjust sliding gear "A" position in or out while lathe is running.

The simple way to adjust the sliding gear "A" is: stop the lathe, put the reverse handle "R" in neutral and adjust Sliding Gear in or out easily

Fig. 568A
Interior View of Gear Box



and quickly. Sliding Gear "A" will not function unless it is set to the extreme of either in or out position—any intermediate position will lock gears.

PREPARING FOR THE FIRST CHIP (THREAD CUTTING)

In cutting screw threads on the lathe, the carriage is driven by clamping half nuts on the lead screw.

The automatic cross feed, or the automatic longitudinal feed of the carriage must not be used while thread cutting. When setting a lathe for thread cutting, place the automatic feed lever knob in position **neutral** and fasten it. This will be necessary because the automatic safety lock will not allow the split nuts to be clamped on the lead screw until the automatic feed lever is in a neutral position.

See that the lathe dog is fastened tightly on the work to be threaded. Also see that the tail of the dog does not bottom on the face plate slot, and that there is oil on the tail center where it enters the work.

Be sure that the thread tool is properly ground and set and fastened firmly in the tool post.

Oil the lead screw and the half nuts.

Do not remove the dog from work until the thread has been finished and tested.

If for any reason you remove the work from the centers for testing the thread, mark the slot on the face plate if there are more than one in which the tail of the dog enters, and when replacing the work on centers, always place the tail of the dog back in the same slot.

The spindle should not be revolved or disturbed while the work is off the lathe centers.

EVEN GEARED LATHES

A lathe is even geared when the revolutions of the spindle and the revolutions of the reverse spindle stud are the same.

In cutting a screw thread if the lathe is even geared and if the number of threads per inch to be cut is exactly divisible by the number of threads per inch of the lead screw, it is not necessary to reverse the direction of the lathe spindle in order to automatically reverse the carriage to return the tool to the starting point. For example: if the lead screw is 8-thread and the screw that you wish to cut is divisible by eight, such as 8, 16, 24, 32, 40, etc., the lathe spindle may run in one direction all the time. When the tool has traveled to the end of the cut draw it out, open the split nut, and return the carriage to the starting position by hand. Throw in the split nut again, take another chip, and repeat this operation until the thread is finished.

The two practical methods of bringing the carriage back to the starting point after taking a threading cut are:

Reversing the direction of spindle rotation causing the carriage to run back automatically;

Opening the split nut and running the carriage back by hand, using the thread dial to engage the split nut.

The first method is used in the shop where there are not many threads to be cut.

The second method is generally followed in production work.

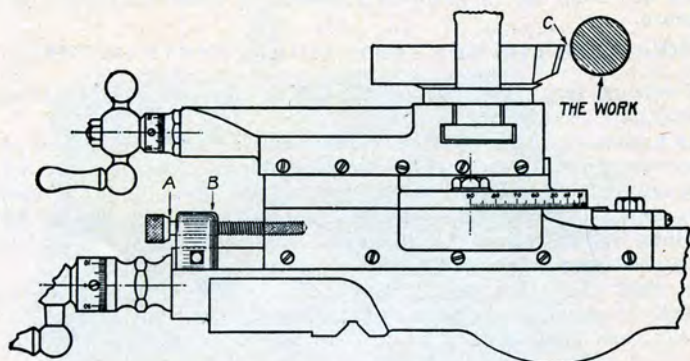


Fig. 569

THE THREAD CUTTING STOP

Fig. 569 shows the application of the adjustable stop for regulating the depth of each chip in thread cutting.

Bring the point of the tool up to the work, then turn the screw "A" until the shoulder is tight against the stop "B," which is clamped to the saddle. When ready to take the first chip, run the tool rest back by the cross feed screw, then turn screw "A" one quarter of a turn to the left. This will allow the point of the tool to take about $\frac{1}{8}$ of an inch on its first chip. Before taking each cut, turn the adjusting screw $\frac{1}{4}$ of a turn to the left.

If the work to be threaded is mild steel or wrought iron, plenty of oil should be used on the point of the tool and on the work.

To take the first chip, move the point of the tool about one-eighth inch away from the surface of the bolt. Move the carriage so as to bring the point of the tool a little to the right of the end of the work, clamp the half nuts firmly on the lead screw and start the lathe. Feed the tool to the work as far as the thread cutting stop will allow and take the first chip. When the tool reaches the end of the cut withdraw it by turning the cross feed screw to the left at least one complete turn so that the tool will clear the thread on the reverse travel of the carriage. Reverse the shipper-rod: this reverses the direction of the feed of the carriage which travels back automatically. When the point of the tool reaches the starting point, stop the lathe and measure the thread to see if you have the correct pitch.

Adjust thread cutting stop by unscrewing $\frac{1}{4}$ turn and take the second chip following the same operation as before, and continue until the thread is finished.

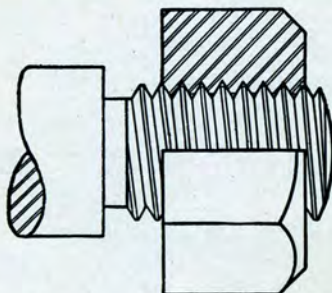


Fig. 570

FITTING AND TESTING SCREW THREADS

When cutting a screw thread and you think it is about finished and ready for testing, remove the work from the lathe centers, leaving the dog attached and test the thread in the threaded hole it is intended to fit, or to some nut or gauge. If the thread does not fit properly and needs another chip or two, place the work back in the centers and take the required chips and test again. Repeat this operation until the thread is finished.

For cutting an internal thread the same general instructions will apply as in cutting an external thread, with the exception that the adjustable stop for thread cutting should be set with the head of the adjusting screw on the inside of the stop.

In cutting screw threads where an accurate job is required; (for example, if you are making a tap) use plenty of lard oil on the tool and the work and be sure that the last or finish cuts are very light, so that the tool will take a fine smooth chip, and leave the surface of the thread smooth and polished.

GRINDING THE THREADING TOOL AFTER THE THREAD HAS BEEN STARTED

If it is necessary to remove the tool for grinding, before thread is finished, take the tool out and grind it, adjust the thread tool as before and fasten it, setting it opposite the thread groove. Turn the spindle forward by hand by pulling on the belt, and again test to see if the point of the tool is exactly opposite the thread in the work. If it is not opposite, disconnect the reverse gear, disconnecting the lead screw, and turn the spindle forward by hand until the tool fits exactly in the thread groove. Then connect the reverse gear as before and you may proceed with the cutting.

In turning the spindle by hand to reset the thread tool, always turn it forward. If you turn it backward, there will be a back lash and it will not show the true position of the tool.

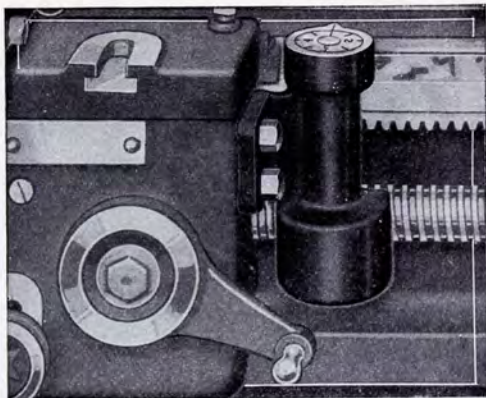


Fig. 571.—Thread Indicator Fitted to the Carriage of the New Model South Bend Lathe

THREAD DIAL ON LATHE

Fig. 571 shows a Threading Dial fitted to the carriage of a lathe. Fig. 572 shows the face of the revolving dial.

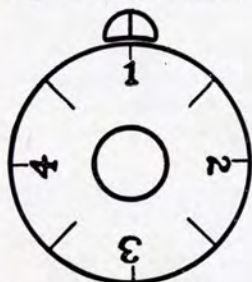


Fig. 572.—Face of Threading Dial

When there are a great many threads to be cut, a Thread Dial is used, as it allows the operator to unclamp the split nut from the lead screw when the end of the thread chip is reached. He can then return the carriage quickly, by hand, to the starting point of the next chip. The thread dial will indicate when to clamp the split nut on the lead screw so that the threading tool will follow in the proper groove for the next chip.

RULES FOR OPERATING THREAD DIAL ON SOUTH BEND LATHE

For all even numbered threads, close the half nuts at any line on the dial. For all odd numbered threads, close the half nuts at any numbered line on dial.

When chasing threads of a pitch involving one-half of a thread in each inch, such as $11\frac{1}{2}$, engage the feed nut at any odd numbered line.

THE SKILLED MACHINIST AND HIS LATHE

The Screw Cutting Lathe is a tool of accuracy and precision. The skilled machinist takes pride in keeping his lathe in first class condition so that he can always turn out accurate work. He knows that if his lathe is given the proper care it will serve him efficiently for a lifetime.

RULE FOR GEARING A LATHE FOR CUTTING SCREW THREADS

One is sometimes called upon to cut a thread on an old lathe from which the index plate has been lost. In this case the following rule will be found useful.

Multiply the number of threads per inch on the lead screw and the number of threads per inch on the bolt to be cut, by any common number that will give for a product the gears that are found with the lathe. For example: We wish to make a bolt having eleven threads per inch. We measure the lead screw and find it has eight threads per inch. Now let us take a common multiple, say 4:

4x11, the thread to be cut, equals 44;
4x 8, the thread of lead screw, equals 32.

The gears 44 and 32 are the gears to use. If the thread to be cut is finer than the thread of the lead screw, the smaller gear goes on the spindle stud, while the larger gear goes on the lead screw.

If the gears 44 or 32 are not found in the equipment, multiply by another number, for example, 5 or 6, etc.

Always measure the thread when you take the first chip to be sure you have made no mistake in the gearing.

CUTTING LEFT HAND THREAD

Fig. 573.—The Left Hand Thread

In cutting a left hand thread in the lathe, the directions are the same as for cutting a right hand thread, except in cutting a left hand thread the feed of the carriage is from left to right or toward the tail stock.

In starting a left hand thread on a screw, it is a good plan, if the work will admit it, to drill a hole in the work about the diameter of the pitch of the thread, and about the same depth as the thread. This will give a definite point for starting each chip.

These instructions for left hand thread apply to all types of left hand screw threads.

ACME SCREW THREADS

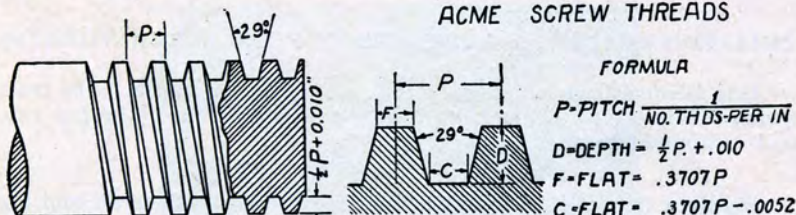


Fig. 574

CUTTING AN ACME SCREW THREAD

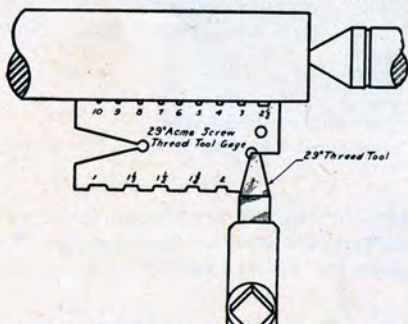


Fig. 575.—Setting an Acme Threading Tool

Fig. 575 shows the method of setting an Acme Threading Tool for cutting an Acme Thread.

If one will place a piece of white paper below the tool on the top of the saddle, the space between the cutting edge of the tool and the gauge can be seen much more clearly.

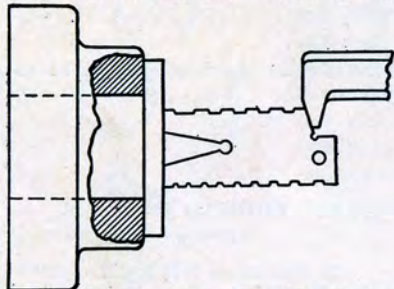


Fig. 576.—Setting an Acme Threading Tool for Internal Threading

INTERNAL ACME THREAD

Fig. 576 shows the method of setting an Acme Threading Tool for internal threading.

A heavy scale or a parallel is set across the face of the work and the legs of the gauge rest on this parallel. Adjust the cutting edge of the tool so that it lines up exactly with the beveled edge of the gauge.

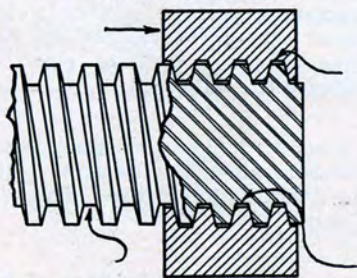


Fig. 577.—Clearance for an Acme Screw Thread

CLEARANCE

In cutting an Acme thread, there should be a clearance of .010" between the diameter at the top of the thread of the screw and the diameter at the bottom of the thread of the nut.

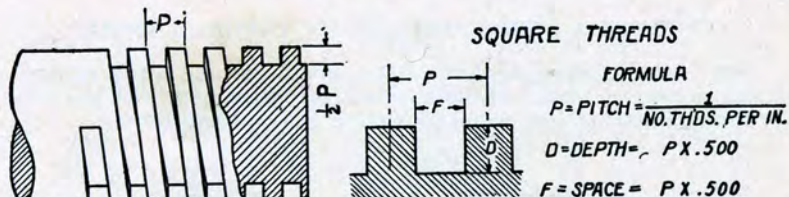


Fig. 578

THE SQUARE SCREW THREAD

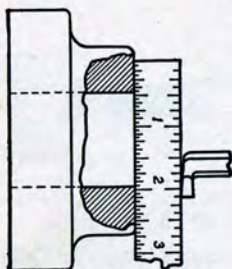


Fig. 579.—Setting the Tool for Square Thread

Fig. 579 shows the method of setting the tool for cutting internal square threads.

The width of the cutting edge of the tool for cutting square screw threads is exactly one-half the pitch, but the width of the edge of the tool for threading nuts is from one thousandth to three thousandths of an inch larger, to permit a sliding fit on the screw.

TOOL FOR SQUARE THREAD

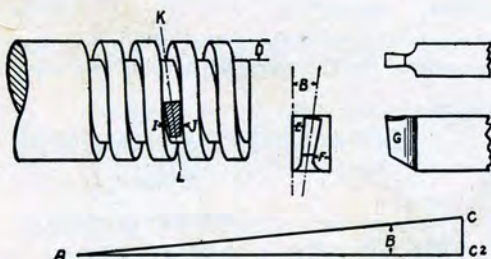


Fig. 580.—Angle of Tool Clearance

Fig. 580 shows the method of arriving at the angle of clearance for making the threading tool.

Draw line A-C2 equal to the circumference of the thread to be cut. Draw line C2-C equal to the lead of the thread and at right angles to line A-C2. Complete the triangle by drawing line

A-C. Angle B in the triangle is the helix angle of the thread and the angle to be used in grinding the tool. The sides of the tool E and F should be given a little clearance when grinding.

CLEARANCE

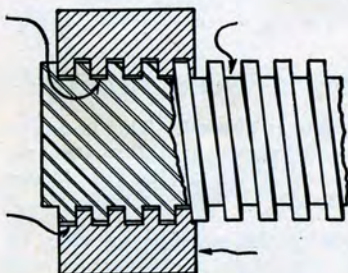


Fig. 581.—Clearance of Diameter

Fig. 581 shows that there should be a clearance between the diameter of the external thread and the diameter of the bottom of the internal thread. This clearance is usually about .005" to .006" for each inch in diameter of the thread.

CUTTING A SCREW THREAD ON TAPERED WORK

The taper attachment of the lathe should be used when cutting a thread on tapered work. If there is no taper attachment with the lathe, the thread on taper can be cut by setting over the tail center.

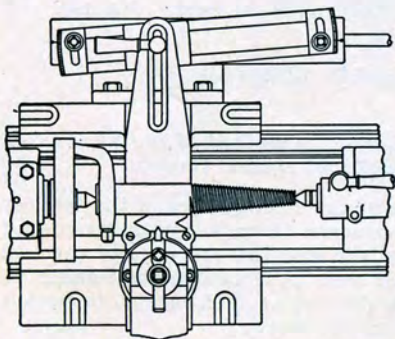


Fig. 582

Fig. 582.—Setting the thread tool for cutting thread on tapered work using the taper attachment.

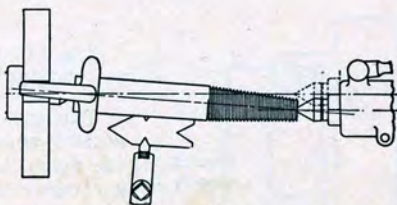


Fig. 582-A

Fig. 582-A shows the method of setting the thread tool for cutting thread on tapered work using the set over tail stock method.

In both the above operations it will be noticed that the outer edge of the thread gauge is set in position on the parallel part of the work.

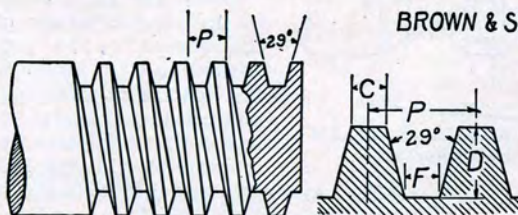


Fig. 583

BROWN & SHARPE 29° WORM THREAD

FORMULA

$$P = \text{PITCH} = \frac{1}{\text{NO. THDS. PER IN.}}$$

$$D = \text{DEPTH} = .6866 P.$$

$$F = \text{FLAT} = .31 P.$$

$$C = \text{FLAT} = .335 P.$$

FORMULA FOR BROWN & SHARPE 29° WORM THREAD

Fig. 583 shows a Brown & Sharpe 29° Worm Thread. This is not to be confused with the Acme Standard Thread because it differs from it, for example in: the depth of the thread, the width of the top of the tooth and the width of the bottom of the tooth.

The thread of the worm and the teeth of the worm gear when in mesh are in contact for about three teeth, and to get more perfect contact the thread is made deeper than the Acme Standard Thread.

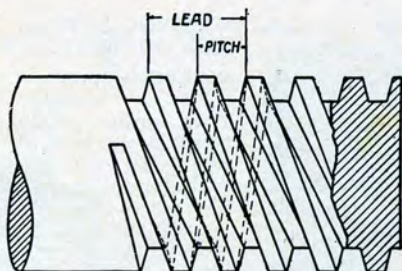


Fig. 584

CUTTING A MULTIPLE THREAD

In cutting a multiple thread between centers, there should be as many slots in the face plate as there are multiples of thread to be cut. For example: to cut a double thread, make two slots in the face plate, one directly opposite the other. It is important that these slots are equidistant from each other in order to divide the threads equally.

Cut each one of the multiple threads exactly in the same manner as you would a single thread. Fasten the dog securely on the work to be cut. Proceed with the cutting as though the screw were a single thread until that thread is finished. Then place the tail of the dog in the opposite slot and proceed with cutting the second thread. The dog must not be removed from the work until both threads have been finished.

If you wish to cut a triple thread, make three equidistant slots in the face plate and proceed as above.

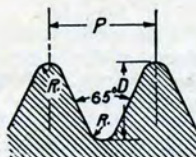
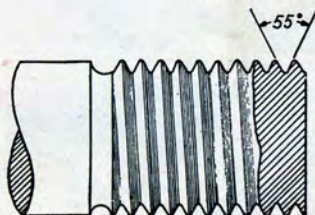
PITCH AND LEAD OF A SCREW THREAD

The pitch of a screw thread is the distance from a point on a screw thread to a corresponding point on the next thread measured parallel to the axis.

$$\text{Pitch (in inches)} = \frac{1}{\text{Number of threads per inch.}}$$

The lead of a screw thread is the distance a screw thread advances axially in one turn. On a single thread screw, the lead and pitch are identical; on a double thread screw, the lead is twice the pitch; on a triple thread screw, the lead is three times the pitch, etc. In cutting multiple threads the lathe should be geared to cut the lead of the thread.

WHITWORTH STANDARD SCREW THREADS

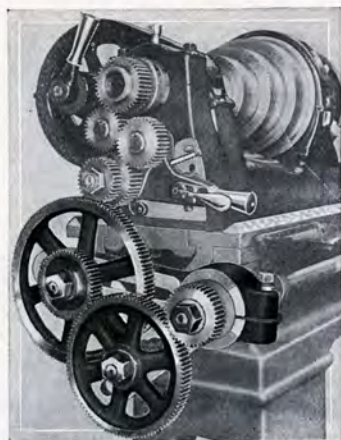


FORMULA

$$P = \text{PITCH} = \frac{1}{\text{NO. TH'DS. PER IN}}$$

$$D = \text{DEPTH} = P \times .6403$$

$$R = \text{RADIUS} = \frac{1}{1373} P \times \frac{1}{\text{NO. TH'DS PER IN.}}$$



Transposing Gears Fitted to Lathe

CUTTING METRIC THREADS WITH TRANSPOSING GEAR ATTACHMENT

On Lathes Equipped with English Lead Screw

In order to cut Standard Metric Threads on lathes equipped with English Lead Screw a Transposing Gear Attachment is used. It consists of a bracket to which is attached two transposing gears of 50 and 127 teeth, respectively, and an idler gear to connect the 50-tooth gear with the gear on the lead screw. Additional change gears are used for cutting the various metric pitches shown in the index charts below.



Transposing Gears and Bracket

METRIC TRANSPOSING GEAR INDEX CHARTS

STANDARD CHANGE GEAR

The chart at right, furnished with the Transposing Gear Attachment for Standard Change Gear Lathes, shows the correct gears to use for cutting the following metric screw threads: .5, .75, 1, 1.25, 1.5, 1.75, 2, 2.5, 3, 3.5, 4, 4.5, 5, 5.5, 6, 6.5, 7, 7.5, 8, m/m pitch.

M/M PITCH	STUD GEAR	COMP. GEARS	SCREW GEAR
5	24	127-50	80
7.5	36	127-50	80
1	48	127-50	60
1.25	60	127-50	80
1.5	36	127-50	40
1.75	42	127-50	40
2	48	127-50	40
2.5	60	127-50	40
3	72	127-50	40
3.5	42	127-50	20
4	48	127-50	20
4.5	54	127-50	20
5	60	127-50	20
5.5	66	127-50	20
6	72	127-50	20
6.5	78	127-50	20
7	84	127-50	20
7.5	90	127-50	20
8	96	127-50	20

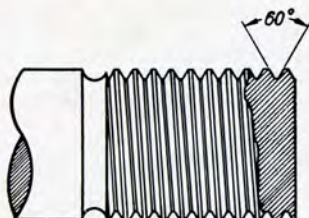
SOUTH BEND LATHE WORKS
SOUTH BEND, IND. U.S.A.

QUICK CHANGE GEAR

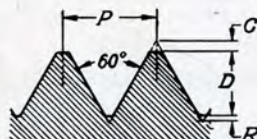
The chart at right, furnished with the Transposing Gear Attachment for Quick Change Gear Lathes, shows the correct gears to use for cutting the following metric screw threads: .5, .75, 1, 1.25, 1.5, 1.75, 2, 2.5, 3, 3.5, 4, 4.5, 5, 5.5, 6, 6.5, 7, 7.5, 8, m/m pitch.

M/M PITCH	STUD GEAR	GEAR	PLUNGER	TOP LEVER
3	72	40	8	LEFT
3.5	72	40	8	RIGHT
1.25	80	40	1	RIGHT
1.5	72	40	1	RIGHT
1.75	84	40	1	RIGHT
2	72	40	8	CH'N
2.5	84	40	1	CH'N
3	72	40	1	CH'N
3.5	84	20	8	CH'N
4	84	20	8	CH'N
4.5	81	20	8	CH'N
5	84	20	1	CH'N
5.5	80	20	1	CH'N
6	84	20	1	CH'N
6.5	78	20	1	CH'N
7	84	20	1	CH'N
7.5	80	20	1	CH'N
8	84	20	1	CH'N

SOUTH BEND LATHE WORKS
SOUTH BEND, IND. U.S.A.



INTERNATIONAL STANDARD METRIC SCREW THREAD



P -PITCH

D -DEPTH- $P \times .7960$

C -TOP FLAT - $\frac{P}{8}$

R -BOTTOM FLAT - $\frac{P}{16}$

INTERNATIONAL STANDARD METRIC SCREW THREADS

The International form of thread has a 60° angle and the crest of thread is flattened $\frac{1}{8}$ th the height of the basic triangle while the root is filled in $\frac{1}{16}$ th the height, either flat or rounded, as shown in the illustration above. This gives a definite clearance between the tops and bottoms of the threads of screw and nut.

MILLING AND KEYWAY CUTTING ATTACHMENT FOR THE LATHE

The Milling and Keyway Cutting Attachment illustrated here is a practical tool for the lathe for doing a great deal of work in the small shop that does not have enough work to install an expensive milling machine. This attachment is capable of turning out the most accurate work on small duplicate parts.

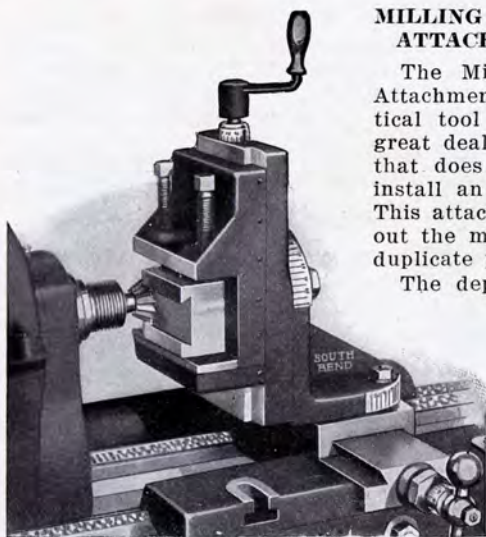


Fig. 587.—Milling a Dovetail in the Lathe

The depth of the cut is controlled by the feed of the lathe carriage, the length by the cross feed screw and the vertical motion by the micrometer graduated adjusting screw at the top of the attachment.

The attachment fits on the saddle of the lathe, swivels all the way around like the compound rest and is graduated 180 degrees.

In addition, the upright angle plate to which the vise is attached swivels vertically and is graduated 180 degrees.

PRACTICAL JOBS FOR THE MILLING ATTACHMENT



Fig. 588.—Squaring the End of a Shaft

Using a Spiral End Mill held in the lathe spindle is an excellent method of milling squares, hexagons and flats, as shown by Fig. 588.

Fig. 590 shows a standard keyway being cut on a shaft. If a taper shaft is to be milled the vise can be tilted to the desired angle for cutting the keyway.



Fig. 590.—Milling a Standard Keyway



Fig. 589.—Milling a Woodruff Keyway

The method of milling a Woodruff keyway in a shaft, using a Woodruff Cutter held in a blacksmith's drill chuck is shown in Fig. 589.

Where a keyway is to be machined in the middle of a shaft a pilot hole is first drilled at each end of the keyway for starting and ending the cut, as illustrated in Fig. 591. A straight shank end mill is being used.



Fig. 591.—End-Milling a Keyway in a Shaft

MILLING CUTTERS AND ARBORS



Fig. 592.—Milling Arbor

A milling arbor for holding milling cutters is illustrated in Fig. 592. The taper shank fits the head spindle of the lathe. The arbor has adjustable spacing collars.

The spiral end mill shown in Fig. 593 has a Morse Taper to fit in the head spindle, and if a smaller taper, a reducing socket can be used.



Fig. 593.—Spiral End Mill



Fig. 594.—Woodruff Keyway Cutter

The milling cutter shown in Fig. 594, is for milling Woodruff system keyways. This is a face milling cutter and is held by a blacksmith's chuck which fits the head spindle.



Fig. 595.—Side Milling Cutter

A side milling cutter is illustrated in Fig. 595. This cutter will mill on either side as well as on the face.



Fig. 596.—Face Milling Cutter

Fig. 596 shows a face milling cutter that is held on the milling arbor for doing face milling. It will cut on the face only.

WOODRUFF KEYWAY

Fig. 597 illustrates a shaft milled for a Woodruff keyway, key inserted. Key should project above shaft one-half its thickness.

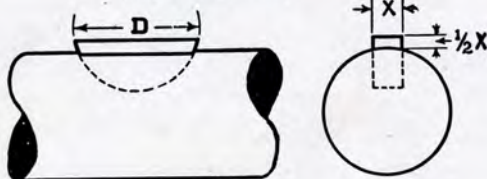


Fig. 597

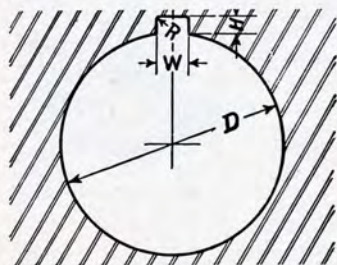


Fig. 598

STANDARD KEYWAYS FOR PULLEYS AND SHAFTS

Fig. 598 shows the recognized standard for the depth and width of keyway in pulleys. The same formula, of course, may be used for the depth and width of keyway in shaft.

Below is a list of the standard sizes of keyways for pulleys and shaft.

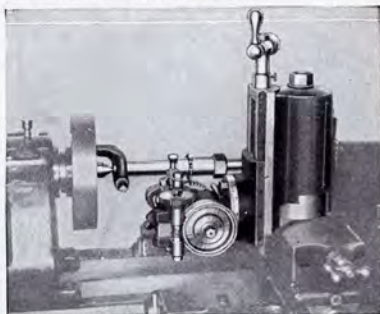
SPECIFICATIONS OF AMERICAN STANDARD KEYWAYS

Diameter Hole D Inches	Width W Inches	Depth H Inches	Radius R Inches	Diameter Hole D Inches	Width W Inches	Depth H Inches	Radius R Inches
$\frac{1}{2}$	$\frac{3}{16}$	$\frac{3}{16}$.020	$2\frac{1}{2}$	$\frac{5}{8}$	$\frac{7}{16}$	$\frac{1}{8}$
$\frac{5}{8}$ to $\frac{7}{8}$	$\frac{1}{4}$	$\frac{1}{4}$		3	$\frac{3}{4}$	$\frac{1}{4}$	$\frac{3}{16}$
1	$\frac{1}{4}$	$\frac{3}{8}$		$3\frac{1}{2}$	$\frac{7}{8}$	$\frac{3}{8}$	$\frac{3}{16}$
$1\frac{1}{4}$	$\frac{1}{4}$	$\frac{1}{2}$		4	1	$\frac{3}{8}$	$\frac{3}{16}$
$1\frac{1}{2}$	$\frac{1}{4}$	$\frac{5}{8}$		$4\frac{1}{2}$	$1\frac{1}{8}$	$\frac{7}{16}$	$\frac{3}{16}$
$1\frac{3}{4}$	$\frac{1}{4}$	$\frac{3}{4}$		5	$1\frac{1}{4}$	$\frac{1}{2}$	$\frac{3}{16}$
2	$\frac{1}{2}$	$\frac{1}{2}$					

GEAR CUTTING ATTACHMENT FOR LATHE**For Cutting Small Gears and for Light Milling Work**

This attachment is equipped with a milling machine dividing head which enables it to be used for cutting small gears and for milling small light work of various kinds on the screw cutting lathe.

The dividing head construction is based on the principle of interchangeable gears, the same as regularly used on gear cutting machines. The index plate shows the proper gears to use for division from 2 to 360 and the number of turns required of the index lever.



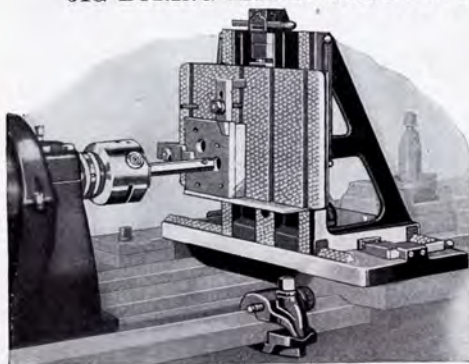
Attachment Mounted on Compound Rest



Millerette Cutting a Gear

VARIETY OF USES

This Attachment will cut gears of all kinds, Spur and Bevel, also Angles. It will do graduating and milling, external key seating of all kinds, cutting at angles, splining, slotting and all regular dividing head, milling machine work.

JIG BORING AND SPACING ATTACHMENT FOR LATHE

Boring a Jig Plate, in the Lathe

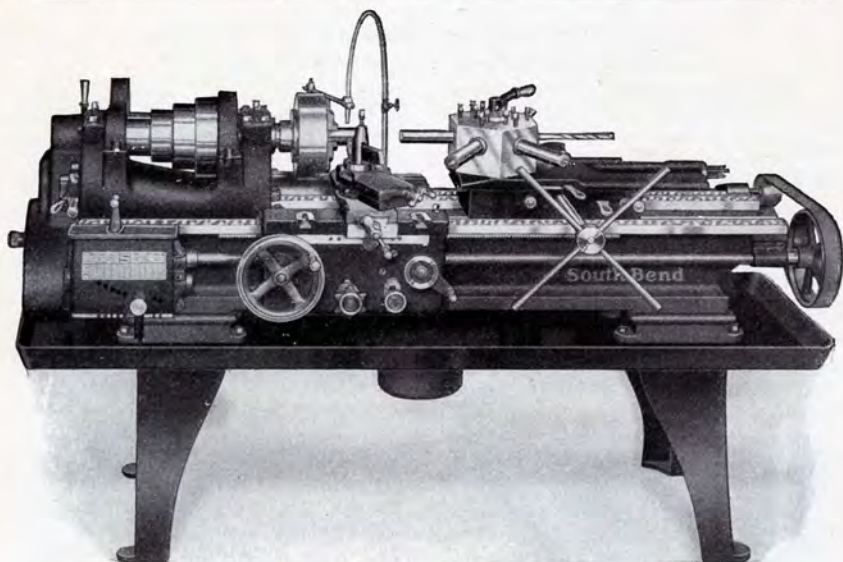
The Jig Boring and Spacing Attachment is practical for use in making dies, jigs, tools, fixtures, etc. It is fitted to the carriage of the lathe as illustrated at left. It has horizontal and vertical adjustments controlled by gauge blocks and by graduated taper wedges having a maximum adjustment of .050 inch, enabling operator to get the most precise adjustments. This attachment will be found very valuable in making fine precision tools.

Precision Gauge Blocks

The Gauge Block Measuring System, such as the Johansson or Hoke, is used with this attachment and provides for all adjustments from "0" to the extreme limits of the machine, without removing blocks while operating. These systems are universally acknowledged as being the most accurate.



Set of 15 Johansson Gauge Blocks



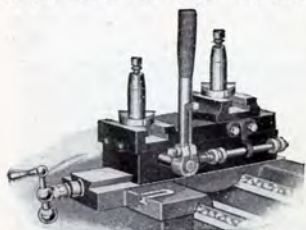
LATHE EQUIPPED FOR MANUFACTURING WORK

The Back Geared Screw Cutting Lathe can be fitted with attachments and used to advantage on many manufacturing operations. The lathe, fitted with a turnstile turret, makes an excellent chucking machine. While the work is held in the chuck a tool may be used in the tool post, using the carriage feed for facing or turning, and the turret tool can be in operation at the same time, operated by an automatic feed on the turret slide.

The lathe above is equipped with a chuck, turnstile bed turret, special boring tools, oil pan and pump. Equipped in this way the lathe serves the purpose of a special machine. When the job is finished the special tools can be removed and the lathe used for regular work.

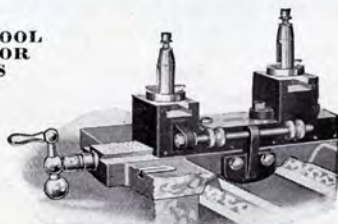
The Screw Cutting Lathe, equipped for manufacturing, will often show better production than a special or single purpose machine.

The use of a double tool slide is practical on many production jobs. It permits the use of one tool in the front for facing and one tool in the back for forming or cutting. Tool slides are made in two types, the hand lever type and the screw type which is controlled by the cross feed screw of the lathe. See illustrations at bottom of page.



Double Tool Slide, Hand Lever

DOUBLE TOOL SLIDES FOR LATHES



Double Tool Slide, Screw Feed

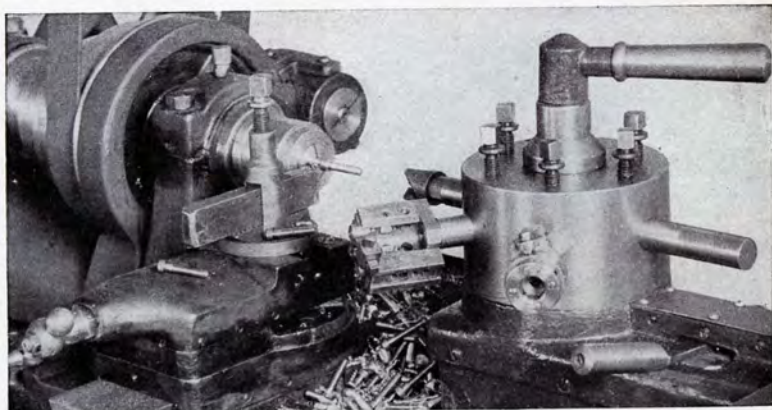


Fig. 610.—A screw cutting lathe fitted with Draw-in Collet Chuck Attachment and hand lever turret, for making small screws. Note the box tool and the threading die.

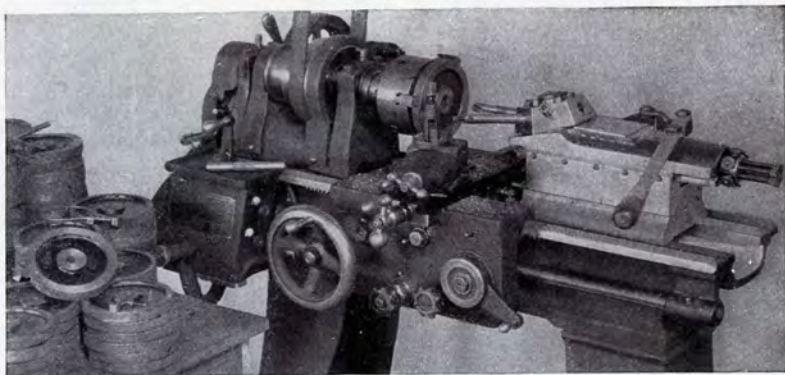
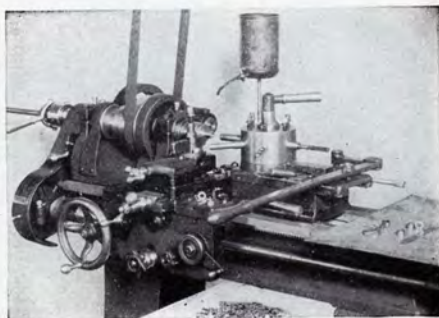


Fig. 611.—Screw cutting lathe fitted with a hand lever turret for machining small gear blanks.

Fig. 612 shows an 11" Screw Cutting Lathe equipped with a hand lever turret slide on bed, and a hand lever closing device for the draw-in chuck attachment. The lathe shown is equipped for making small brass machine screws.



THE HAND LEVER TURRET

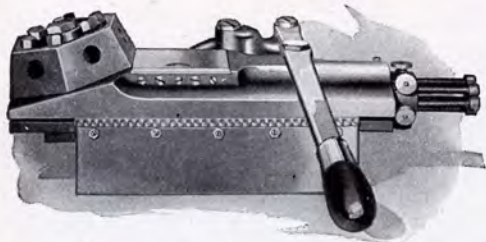


Fig. 604.—The Hand Lever Turret

be seen at the right end of the turret slide. The hand lever turret revolves one-sixth of a turn each time the lever is pushed back beyond the latch.

THE TURRET ON SADDLE

Fig. 605 shows the application of the turret on the saddle of the lathe. This saddle turret is semi-automatic and must be revolved by hand. In using a saddle turret on the lathe, the center of the turret holes should line up with the axis of the head spindle and there should be a gauge or a stop on the saddle so that the turret hole would line up with the spindle hole in the operation of each tool. Sometimes the turret is located in position by a taper pin which fits into a hole drilled through the turret base and saddle top.

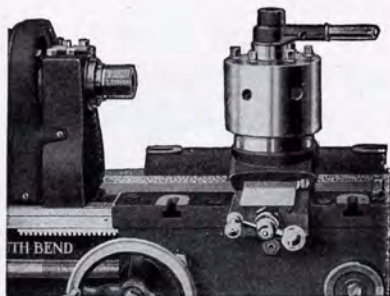


Fig. 605.—The Turret on Saddle

TOOL POST TURRET

Fig. 606 shows the application of a tool post turret held in the compound rest of the lathe. It is semi-automatic and must be revolved by hand after each tool has been in action. There should be a similar gauge or a stop on the saddle in operating the tool post turret so as to always bring the operating tool to the center or axis of the lathe spindle.

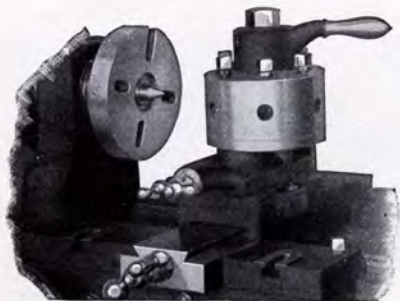


Fig. 606.—The Tool Post Turret

THE USE OF THE BORING BAR IN THE LATHE

The boring bar is held between centers and driven by a dog. The work is clamped to the top of the lathe saddle and is fed to the tool by the automatic longitudinal feed of the carriage.

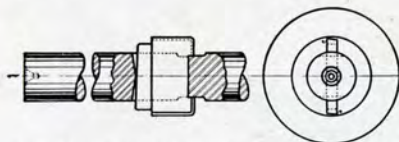


Fig. 613.—Boring Bar for Sizing the Hole

Fig. 614 shows a boring bar fitted with a fly cutter held by a headless set screw. Another headless set screw at the end of the cutter adjusts it to the work.



Fig. 614.—Boring Bar with a Fly Cutter

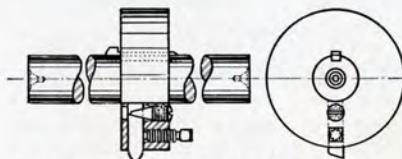


Fig. 615.—Boring Bar with a Boring Head

Fig. 615 shows a boring bar fitted with a cast iron head for boring work of large diameter. The head is fitted with a fly cutter which is held by a set screw and adjusted by a headless set screw having a tapered point.

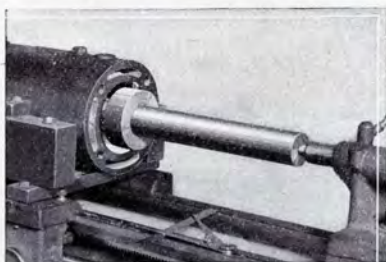


Fig. 616.—Reboring an Engine Cylinder

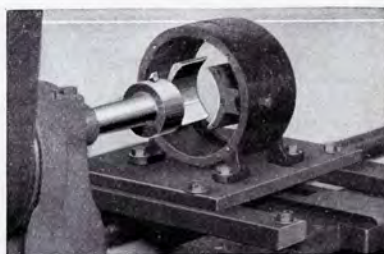


Fig. 617.—Boring Field Poles of a Motor

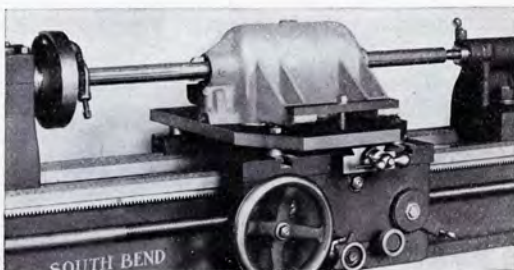


Fig. 618.—Boring a Transmission Case in the Lathe

Fig. 618 shows a transmission case being bored in a lathe. The tool rest has been removed and an auxiliary plate bolted to the saddle. This plate may be adjusted for height by the collars or washers underneath. The case is clamped in position on the plate, and the boring bar is driven on the lathe centers.

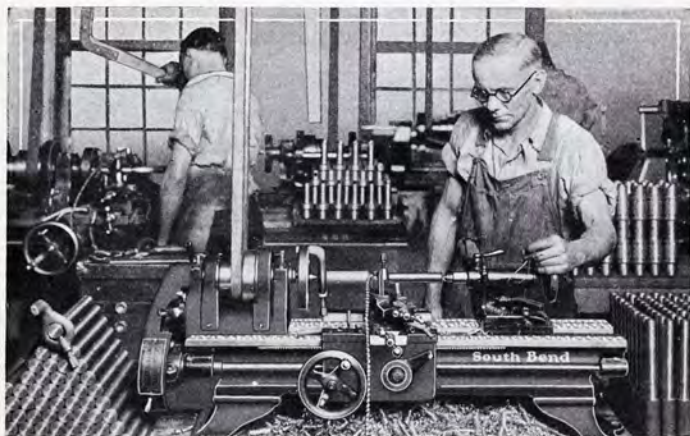


Fig. 607.—A 9-inch Bench Lathe on a Manufacturing Job

THE SMALL LATHE AS A MANUFACTURING TOOL

In the Manufacture of Small Duplicate Parts on a Production Basis

The best shop practice is to manufacture small parts on a small lathe tooled to take care of the job, because of the speed and accuracy with which operations can be performed. Two or more small lathes are frequently operated on quantity production by one mechanic.

Production engineers in large manufacturing plants making products such as sewing machines, typewriters, watches, radios, electrical parts, etc., are using small lathes in the manufacture of small metal parts that require the greatest accuracy because they must be interchangeable.

When one job is finished the screw cutting lathe can be set up for doing a different job, and can be kept in operation the year around. Many industrial plants are taking advantage of this fact and are using screw cutting lathes, equipped with special tools, in groups on production work and are getting excellent results. They find that this type of equipment is less expensive and far more productive.

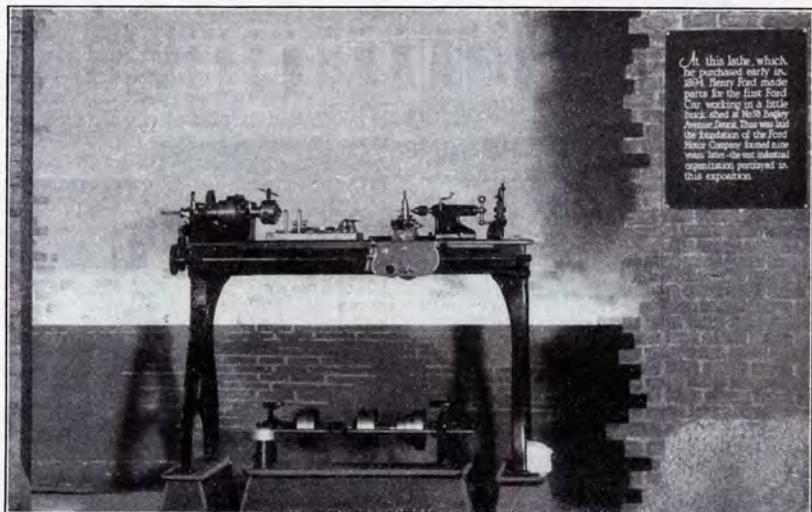
The screw cutting lathe can be fitted with a number of practical attachments such as lathe chucks, drill chucks, draw-in collet chucks, spring collets, taper attachment, grinding attachment, etc., and used for a wide variety of manufacturing operations.



Fig. 608.—Using a Draw-in Chuck and Turret for Making Small Screws



Fig. 609.—Forming and Cutting Off Duplicate Parts from Bar Stock



At this lathe, which he purchased early in 1894, Henry Ford made parts for the first Ford Car, working in a little brick shed at No. 58 Bagley Avenue, Detroit. Thus was laid the foundation of the Ford Motor Company formed nine years later—the vast industrial organization portrayed in this exposition.

HENRY FORD'S FIRST LATHE

Used in Making Parts for the First Ford Car

The illustration above shows the back geared screw cutting engine lathe used by Henry Ford in building the first Ford automobile. The photograph was taken at the New York Automobile Show, 1927, where the lathe was put on display so that the thousands of visitors might see how Henry Ford got his start in building his tremendous organization.

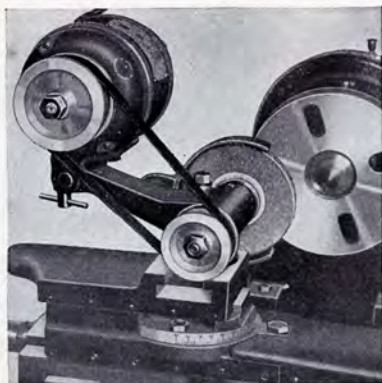
The placard at the right of the lathe reads as follows:

“At this lathe, which he purchased early in 1894, Henry Ford made parts for the first Ford Car, working in a little brick shed at No. 58 Bagley Avenue, Detroit. Thus was laid the foundation of the Ford Motor Company formed nine years later—the vast industrial organization portrayed in this exposition.”

This lathe, as can be seen, is what is known as a “small lathe.” The swing capacity is 11” and it takes about 30” between centers. On it Henry Ford made the principal parts for his automobile, machining the parts himself.

The Advantage of the Small Lathe

Small lathes, such as the 9” and 11” lathes, have always been used to excellent advantage by the skilled mechanic. The 9” x 4’ lathe, for example, has the capacity for machining a shaft 6 $\frac{3}{8}$ ” in diameter and 29” long. On chucking work a steel ring or flange 9 $\frac{1}{4}$ ” in diameter can be machined in the chuck. The 9” lathe may be fitted with a variety of attachments for the machining of small accurate work. Screw threads from 4 to 40 per inch, including 11 $\frac{1}{2}$ pipe thread, can also be cut. One can readily understand how Henry Ford used to advantage a lathe of this type in building his first Model T car.



Grinder Mounted on Compound Rest

the work in each cut. If considerable stock is to be removed use the turning tool of the lathe to reduce the work to within a few thousandths of the finished size. Two or three cuts with the grinder will then produce a smooth, accurate surface. Grind only when you cannot machine; for example, on work that has been hardened or tempered.

In using a grinding wheel 4" to 6" in diameter the depth of the cut should not be more than .001". On the finishing cut .0015" on the diameter of the work will leave a better finish.

GRINDING HARDENED BUSHINGS, REAMERS AND CUTTERS

The illustrations here show the electric grinder on several practical grinding jobs. In grinding cutters and reamers set the clearance stop to the proper height and hold the cutter against the stop with one hand, feeding the wheel with the other. Repeat the operation on each flute. On spiral cutters rotate the cutter as the grinding wheel is fed across the cutting edge of the flute. When grinding angles or tapers the compound rest must be set to the proper angle and the center of the grinding wheel spindle should be on the same plane or at exactly the same height as the point of the lathe center.

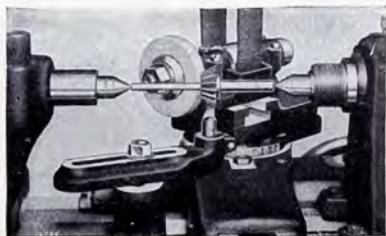
ELECTRIC GRINDER FOR THE LATHE

The electric grinder is mounted on the compound rest of the lathe and swivels to any angle for grinding all kinds of reamers and cutters, straight, taper, or spiral; also for grinding milling cutters, lathe centers, taps, dies, etc. It operates from an ordinary light socket.

The grinder should be used only to take light or finishing cuts because the emery wheel is small and runs at high speed so that in taking a heavy cut the wear on the wheel is oftentimes greater than the amount of stock removed from



Grinding a Hardened Steel Bushing

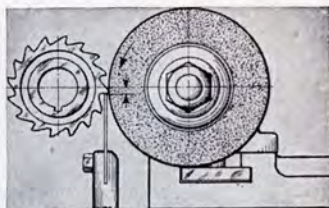


Grinding an Angular Cutter in the Lathe



Grinding a Straight Reamer in the Lathe

When grinding or sharpening hardened reamers or cutters, straight and bevel, the adjusting stop which regulates the position of the cutting edge of the reamer flute should be set accurately, as in the illustration at the right so as to get the proper clearance on the cutting edge.



Grinding Clearance on a Milling Cutter



Grinding the inside of a Steel Bushing

Above is illustrated the Electric Grinder fitted with an internal grinding spindle for grinding holes in hardened cutters or small bushings. The correct speed for internal grinding is obtained by transposing the pulleys of the grinder.

TRUING THE GRINDING WHEEL

The illustration at the right shows a grinding wheel being trued by a black or commercial diamond. The diamond is held in a fixture, the revolving wheel is brought up to the diamond point and fed slowly across the face of the diamond. Two or three cuts are sufficient to true the wheel properly.



Truing a Grinding Wheel

Diamond Dresser for Truing Emery Wheel

EMERY WHEEL SPEEDS

Grinding wheels are run in actual practice from 4,000 to 6,000 feet surface speed per minute.

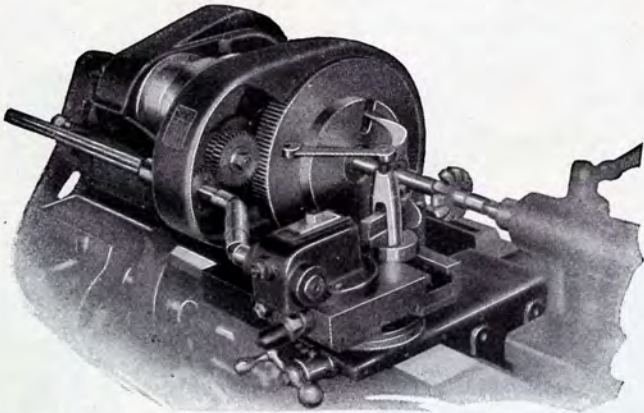
Below we give the number of revolutions of wheels of different diameter for 4,000 and 5,000 feet surface speed per minute.

Diam. Wheel	1 in.	2 in.	3 in.	4 in.	5 in.	6 in.	7 in.	8 in.	10 in.	12 in.
R.P.M. for surface Speed of 4,000 ft.....	15,279	7,639	5,093	3,820	3,056	2,546	2,183	1,910	1,529	1,273
R.P.M. for surface Speed of 5,000 ft.....	19,099	9,549	6,366	4,775	3,820	3,183	2,728	2,387	1,910	1,592

GRINDING WHEELS FOR VARIOUS KINDS OF WORK

There are various grades of emery or grinding wheels, all of which are marked for special kinds of work such as cast iron, steel, grinding hardened tools, etc. We herewith show a tabulation showing the grain and grade of Norton Grinding wheels for different work.

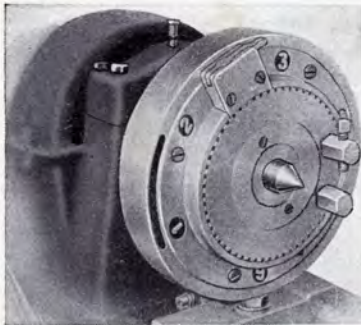
Kind of Work	Name of Wheel (Norton)	Grain	Grade
Cast Iron.....	Crystalon	36	K
Steel	Alundum	46	M
Cutting Tools.....	Alundum	19	50-K
Valves	Alundum, Shellac.....	60	3



RELIEVING OR BACKING OFF ATTACHMENT FOR THE LATHE

Illustration above shows a relieving or backing off attachment that is attached to the head spindle of a lathe. The attachment is used for the backing off of cutters, taps, etc. It requires very little time to attach to the lathe, and when the required tools are relieved or backed off the attachment can be removed.

SPEED REDUCING AND INDEXING ATTACHMENT For Relieving, Thread Chasing and Indexing

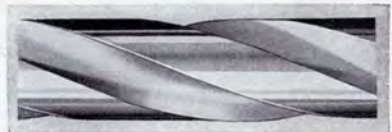


Speed Reducing and Indexing Attachment for Back Geared Lathes

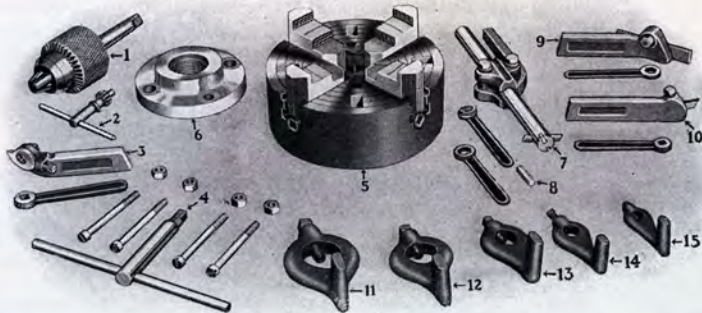
This attachment provides unusually slow speeds required for relieving operations, precision thread chasing and indexing. Designed for mounting on the spindle nose, it is extremely simple to use and is attached or removed about as easily and quickly as an ordinary face plate. Planetary gearing is used to give a 6 to 1 speed reduction from whatever spindle speed is engaged. For this purpose, six index numbers are placed on the face of the attachment, and by engaging the lead screw when the proper number is opposite the index mark the above numbers of starts can be obtained without the notches.

Multiple Starts

A plate with 60 notches gives every subdivision needed for ordinary work requiring multiple starts. It is possible to cut 1, 2, 3 and 6 starts simply by making use of the 6 to 1 speed reduction.



A Shaft with 3 Starts or Grooves of 1 Turn in 3 Inches



No. 109.—Chuck and Tool Assortment for 9-inch Lathe, Consisting of:

1—3-Jaw Drill Chuck with Arbor Attached; 2—Pinion Key for Drill Chuck; 3—Formed Threading Tool and Wrench; 4—Wrench and Cap Screws for Chuck; 5—4-Jaw Independent Lathe Chuck; 6—Semi-Machined Chuck Back; 7—Style "B" Patent Boring Tool and Wrenches; 8—High Speed Steel Cutter Bit; 9—Right Hand Patent Cutting-off Tool and Wrench; 10—Straight Shank Patent Turning Tool and Wrench; 11 to 15—Malleable Lathe Dogs, $\frac{1}{2}$ in. to $1\frac{1}{2}$ in. capacity.

PRACTICAL CHUCK AND TOOL ASSORTMENTS

An Assortment for Each Size Lathe

The Chuck and Tool Assortment illustrated above is the most practical size for use on the 9-inch Back Geared Screw Cutting Lathe for general machine work. Each size lathe requires a different Chuck and Tool Assortment as listed below. These assortments represent the result of our 24 years of experience in equipping shops of various kinds.

The 4-Jaw Independent Lathe Chuck has been specified in some of the assortments, but if much round work is to be done, then a 3-Jaw Universal Geared Chuck may be substituted. For information on chucks see pages 61 to 63.

Assortment for 9-inch Lathes

- 1—6-inch, 4-Jaw Independent Lathe Chuck.
- 1—3-Jaw Drill Chuck, $\frac{1}{2}$ -inch capacity.
- 1—Drill Chuck Arbor, fitted to Chuck.
- 1—Patent Turning Tool, straight shank.
- 1—Patent Threading Tool.
- 1—Patent Boring Tool, Style B.
- 1—Patent Cutting Off Tool (Right Hand).
- 5—Malleable Lathe Dogs, $\frac{1}{2}$ " , $\frac{3}{4}$ " , 1" , $1\frac{1}{4}$ " $1\frac{1}{2}$ " .

Assortment for 11-inch Lathes

- 1—6-inch, 4-Jaw Independent Lathe Chuck.
- 1—3-Jaw Drill Chuck, $\frac{1}{2}$ -inch capacity.
- 1—Drill Chuck Arbor, fitted to Chuck.
- 1—Patent Turning Tool, straight shank.
- 1—Patent Threading Tool.
- 1—Patent Boring Tool, Style B.
- 1—Patent Cutting Off Tool (Right Hand).
- 5—Malleable Lathe Dogs, $\frac{1}{2}$ " , $\frac{3}{4}$ " , 1" , $1\frac{1}{4}$ " $1\frac{1}{2}$ " .

Assortment for 13-inch Lathes

- 1—8-inch, 4-Jaw Independent Lathe Chuck.
- 1—3-Jaw Drill Chuck, $\frac{1}{2}$ -inch capacity.
- 1—Drill Chuck Arbor, fitted to Chuck.
- 1—Patent Turning Tool, straight shank.
- 1—Patent Threading Tool.
- 1—Patent Boring Tool, Style B.
- 1—Patent Cutting Off Tool (Right Hand).
- 5—Malleable Lathe Dogs, $\frac{1}{2}$ " , $\frac{3}{4}$ " , 1" , $1\frac{1}{2}$ " , 2" .

Assortment for 15-inch Lathes

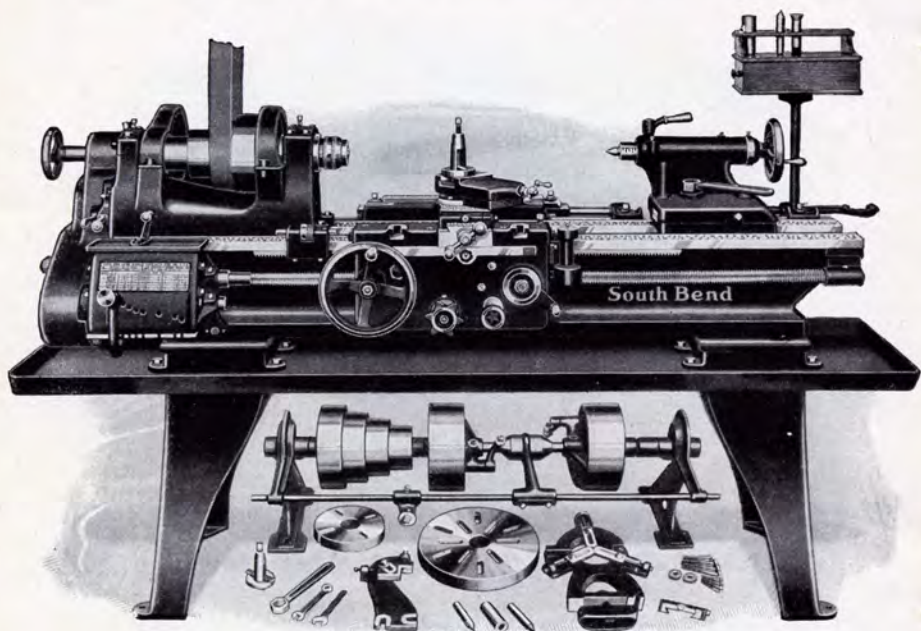
- 1—9-inch, 4-Jaw Independent Lathe Chuck.
- 1—2-Jaw Drill Chuck, 1-inch capacity.
- 1—Drill Chuck Arbor, fitted to Chuck.
- 1—Patent Turning Tool, straight shank.
- 1—Patent Threading Tool.
- 1—Patent Boring Tool, Style B.
- 1—Patent Cutting Off Tool (Right Hand).
- 5—Malleable Lathe Dogs, $\frac{1}{2}$ " , $\frac{3}{4}$ " , 1" , $1\frac{1}{2}$ " , 2" .

Assortment for 16-inch Lathes

- 1—10-inch, 4-Jaw Independent Lathe Chuck.
- 1—2-Jaw Drill Chuck, 1-inch capacity.
- 1—Drill Chuck Arbor, fitted to Chuck.
- 1—Patent Turning Tool, straight shank.
- 1—Patent Threading Tool.
- 1—Patent Boring Tool, Style B.
- 1—Patent Cutting Off Tool (Right Hand).
- 5—Malleable Lathe Dogs, $\frac{1}{2}$ " , $\frac{3}{4}$ " , 1" , $1\frac{1}{2}$ " , 2" .

Assortment for 18-inch Lathes

- 1—12-inch, 4-Jaw Independent Lathe Chuck.
- 1—2-Jaw Drill Chuck, 1-inch capacity.
- 1—Drill Chuck Arbor, fitted to Chuck.
- 1—Patent Turning Tool, straight shank.
- 1—Patent Threading Tool.
- 1—Patent Boring Tool, Style B.
- 1—Patent Cutting Off Tool (Right Hand).
- 5—Malleable Lathe Dogs, $\frac{3}{4}$ " , $1\frac{1}{2}$ " , 2" , $2\frac{1}{2}$ " , 3" .



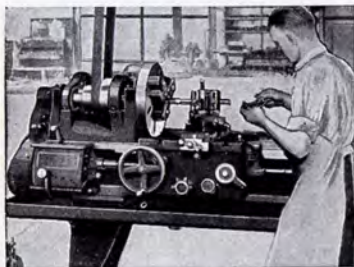
THE TOOL ROOM PRECISION LATHE

With Overhead Countershaft Drive

The tool room precision lathe, as its name implies, is used in the tool rooms of industrial plants for making fine tools, test and thread gauges, fixtures, etc., used in the making and testing of their manufactured products.

The tool room precision lathe is the modern back geared quick change screw cutting lathe with the addition of such equipment as draw-in collet chuck attachment, taper attachment, thread dial, micrometer stop, etc., and generally an oil pan.

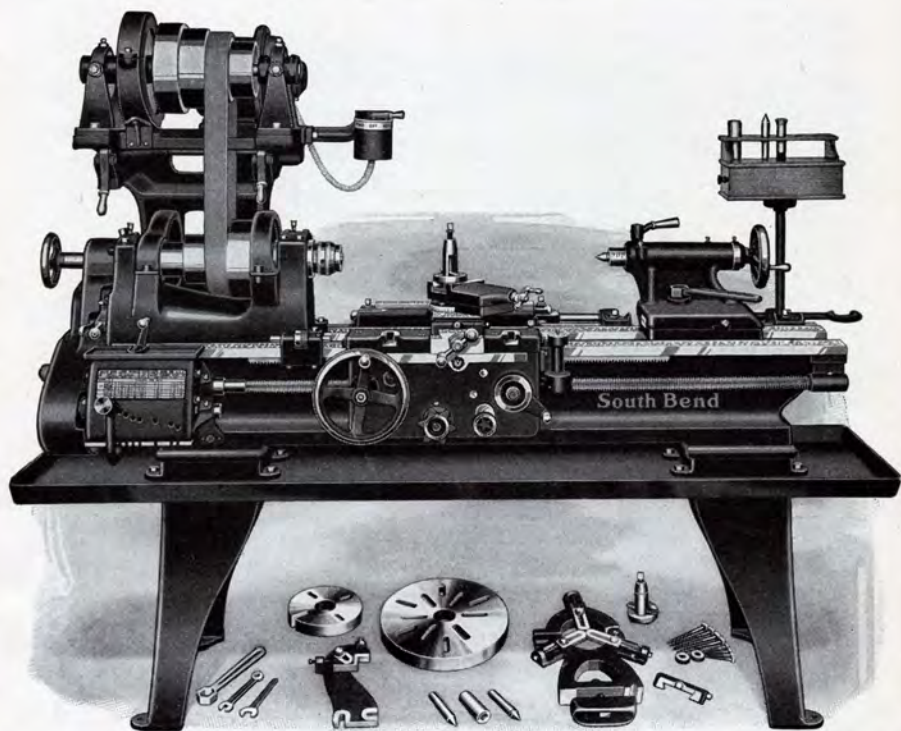
Usually there are five sizes of tool room precision lathes—11"x4', 13"x5', 15"x6', 16"x6' and 18"x8'—countershaft drive or motor drive.



Boring a Jig in the Tool Room Lathe

Being a tool room precision lathe does not mean these lathes are not also often used for other work of more general nature. However, in many plants, tool room lathes are used exclusively for fine, accurate tool work. Some tool room lathes are grouped ten, twenty, or thirty to one room, varying of course, according to the size of the plant.

(Continued on Page 119)

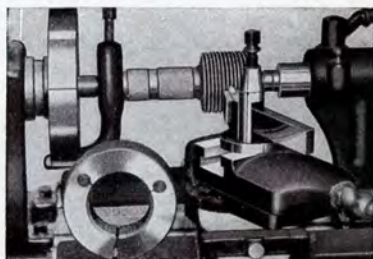


TOOL ROOM PRECISION LATHE WITH MOTOR DRIVE

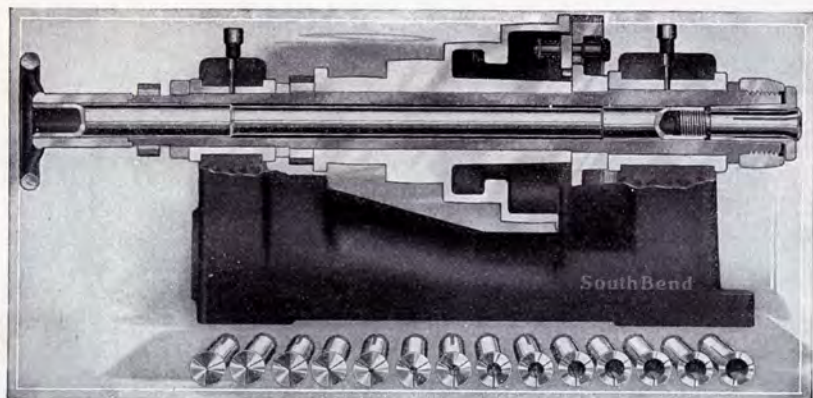
(Description Continued from Page 118)

The belt driven spindle cone type of lathe is more popular and considered to be the most practical type of driving power for a tool room lathe. This is because a belt drive transmits no vibration to the spindle. Therefore work produced on a lathe having a belt driven spindle has an extra fine, smooth finish and more accurate surface, so absolutely necessary when taking a finishing cut on master taps, screw and plug gauges, etc.

The new model silent chain motor driven tool room precision lathe, shown above, while deriving its original driving power from a motor unit, has a belt drive between the countershaft and spindle cone. The motor drives the countershaft by a silent chain which eliminates all vibration. For a detailed description of the new model silent chain motor driven lathe, see pages 122 and 123.



Making a Master Screw Thread Gauge



A Cross Section of the Headstock showing Hand Wheel Draw-in Collet Chuck

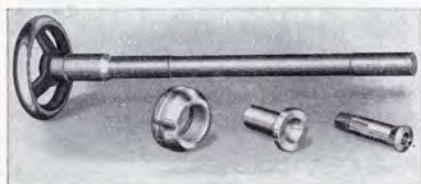
DRAW-IN COLLET CHUCK ATTACHMENT ON THE LATHE

The cross section view of the lathe headstock shows the application of the draw-in collet chuck. The hollow draw bar, internally threaded on the end, extends through the hole in the lathe spindle and screws on the threaded end of the steel split collet. Rotating the draw-bar to the right draws the collet into the take, closing sleeve and causes the collet to tighten on the work; to the left releases the work.

The Collet Chuck Attachment is used in the tool room for fine, accurate work and in industry for the production of small precision parts of such articles as watches, typewriters, sewing machines, adding machines, radios, etc. Either long or short pieces of material may be held in the chuck for machining. The hollow draw bar permits bars and rods being passed through the lathe spindle and held in the chuck for machining. This method of manufacturing small parts is accurate, rapid and economical.

The skilled mechanic and tool maker are very partial to the draw-in collet chuck as it permits the greatest accuracy in the making of small, delicate parts.

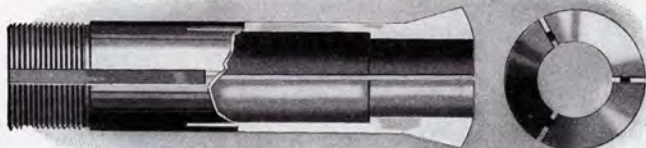
The Hand Wheel Type Draw-in Collet Chuck Attachment is used extensively in the tool room in making small tools and parts where accuracy is essential. It is the most accurate type of chuck made and is the choice of experienced tool makers and machinists for fine, accurate work. It consists of a hand wheel and hollow draw bar, nose cap for protecting threads of spindle nose, taper steel closing sleeve and a collet.



Hand Wheel Draw-in Collet Chuck Attachment



Split Collet for holding Round Work in the Draw-in Chuck Attachment



Side and Front View of Collet Showing Construction

CONSTRUCTION OF SPLIT COLLETS

Above is illustrated a cross section of a hardened and ground tool steel split collet. Notice the three slots which divide the tapered end of the collet into three segments. These slots permit the collet to be contracted or expanded as it is drawn into or released from the tapered closing sleeve in the lathe spindle. The left end is threaded for the hollow draw bar and has a keyway to prevent the collet from turning while holding the work. Collets are ground both outside and inside to insure accuracy.

TYPES OF SPECIAL SPLIT COLLETS

The collets illustrated are for holding round, square or hexagonal stock. The Round Split Collet is illustrated on page 120. Collets are furnished from $\frac{1}{16}$ inch diameter to the spindle hole capacity of the lathe by 64ths. Collets with special hole sizes



Square

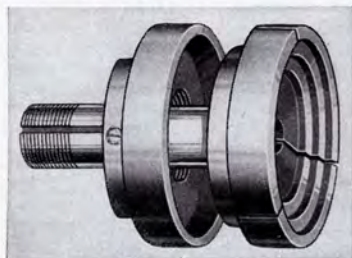


Hexagon



Step Collet

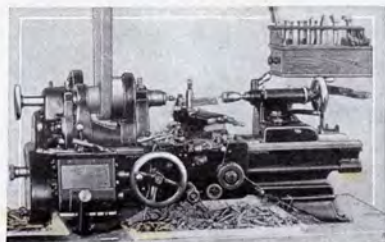
can be furnished by the manufacturer.



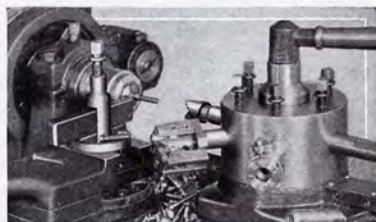
Step Chuck and Closer

STEP CHUCKS AND CLOSER

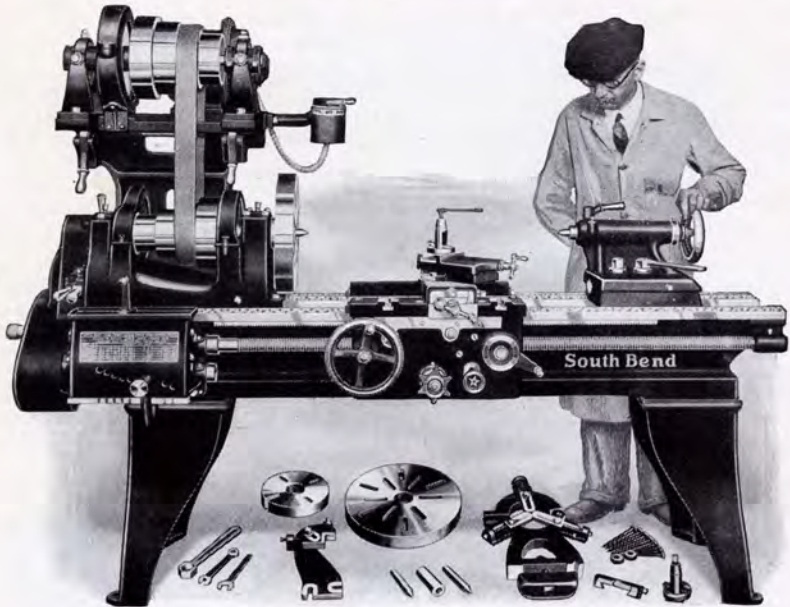
The Step Chuck and Closer is extremely useful for holding metal discs, thin tubing, etc. The disc or wheel to be held in the step chuck is placed in the proper step and then with a draw-in chuck attachment is drawn back to the closer which has a taper wall to close the step chuck on the work to be held.



Lathe Equipped with Collet Chuck Manufacturing Small Screws



Collet Chuck used with Turret Making Duplicate Parts



THE SILENT CHAIN MOTOR DRIVEN LATHE

The illustration above shows the improved Silent Chain Motor Drive for a Back Geared Screw Cutting Lathe. The countershaft cone is mounted on a tilting table placed directly above the spindle cone of the lathe. Behind this cone is mounted a motor which drives the countershaft by means of a silent chain. The final drive is through a leather belt from the driving cone to the spindle cone of the lathe, which prevents vibration and noise and permits the spindle to revolve smoothly and quietly so the cutting tool will leave a smooth, even surface on the work.

Leather belting should always be used as the final drive for a lathe which is used for accurate work as it has the resiliency to absorb shock and vibration. Some lathes are driven entirely by gears and the metal-to-metal contact, together with the continuous rotation of a large number of gears, cause vibration and shock, which are transmitted to the cutting tool so that tool marks are left on the finished surface.

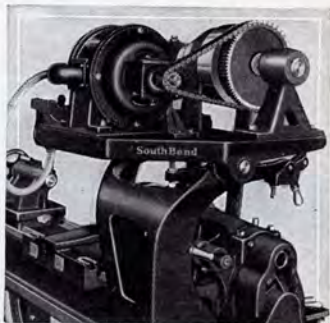
The Silent Chain Motor Driven Lathe is practical because the motor is of the reversing type and is operated by a reversing switch. By throwing the switch lever to the left it starts the lathe in forward motion, by throwing it to the right it reverses the rotation of the spindle, and by throwing the handle to the center, which is the neutral position, it stops the motor.

The Silent Chain Motor Drive is widely used in some of the largest industrial plants in the United States, and is the most practical and popular type of drive for a lathe. The simplicity of construction and the low price insure economical operation. The General Electric and Westinghouse Companies show this drive in their permanent exhibits at Atlantic City, where it may be seen and inspected at any time.

INFORMATION ON MOTOR DRIVEN LATHES

A Motor Driven Lathe is a lathe that has an electric motor mounted as a part of the lathe itself. This motor has a Reversing Control Switch of the drum type. The Control Lever has three positions—Left, for Forward Speeds; Right, for Reverse Speeds, and Center, for Neutral.

When installing a motor driven lathe the reversing motor should always conform to the electric current of the locality. Exact current specifications are therefore necessary when ordering. These specifications can be secured from the power company of the locality or taken from the electric meter measuring the power of the shop where the lathe will be set up. These specifications may be:



End View of Silent Chain Drive



Alternating Current—of Single, Two or Three Phase, any Cycle and any Voltage.

Direct Current—of any Voltage.

ALTERNATING CURRENT

Single Phase Alternating Current is used extensively for lighting purposes. As a rule, ordinary electric light circuits are not of sufficiently heavy voltage to operate more than a One-Half H.P. Motor. Some cities will not permit more than a One-Quarter H.P. Motor to be operated from light circuits. Usually this is covered by a City Ordinance, which also outlines the code of all electric specifications. Larger motors can be operated on Single Phase current by installing special wiring which is safer, more economical, and durable.

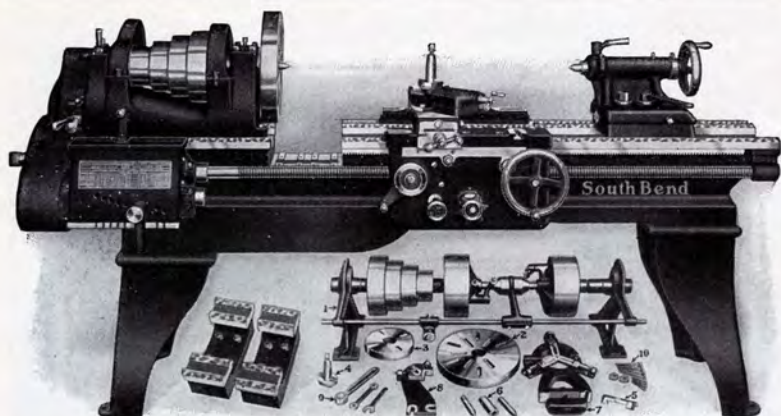
DIRECT CURRENT

Direct Current is not widely used. However, there are some localities where it is the only available current. Any Direct Current Motor will operate from any Direct Current Line of the same Voltage Rating. In addition to the Control Switch furnished for Direct Current Motors, for reasons of safety, a special starting equipment is also required on all Direct Current motors of One H.P. or larger capacity. A simple resistance unit, designed to operate the Reversing Type motor, is sufficient for the operation of ordinary screw cutting lathes, and is furnished by motor manufacturers at slight additional cost.

When ordering electric motors for lathes, always state the exact specifications. When installing any motor driven lathe, always make sure the specifications are correspondingly correct. Specifications should definitely show one of the following:

Alternating Current—Phase, Cycle and Voltage.

Direct Current—Voltage only.



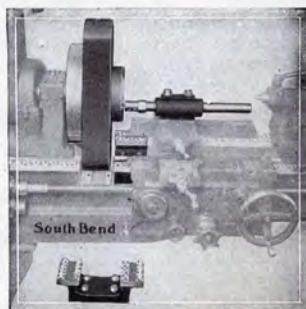
THE IMPROVED GAP LATHE WITH DOUBLE BRIDGE

The illustration shows the improved Gap Lathe with Double Bridge. This Lathe is used for machining work of large diameter. The Gap Lathe permits the swinging of work of large diameter over the gap, but does not increase the machining capacity of the lathe. For example it will swing a flywheel or a brake drum, and permit the hub of the fly wheel to be machined, and the brake drum of the automobile wheel, but will not permit machining of the fly wheel or the auto wheel on the outside diameter, if it is larger than the swing or capacity of the lathe.

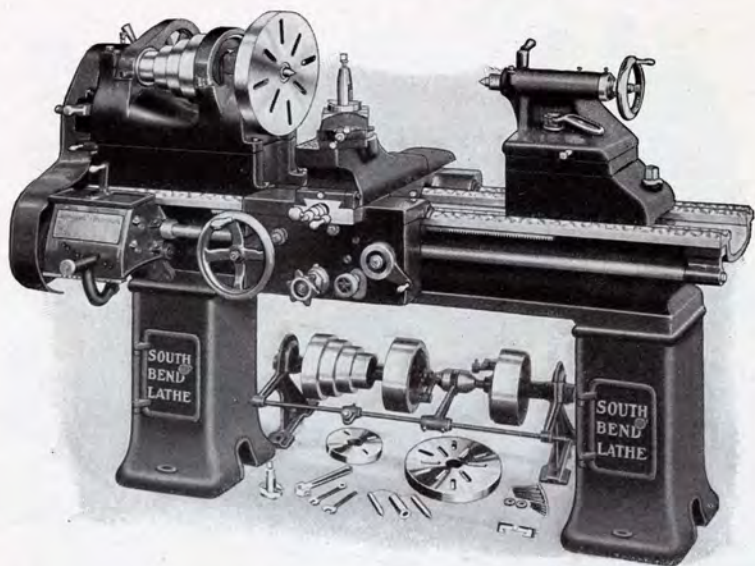
On Gap Lathes the control mechanism of the apron is transposed so that the carriage can be fed by hand or power over the gap for machining narrow work. Refer to pages 8 and 9 for other features of this lathe as they are the same as found on the regular Quick Change and Standard Change Gear Lathes.



Double Bridge Removed from Gap for Extremely Wide Work



One Bridge Removed for Narrow Work, the Other Bridge Remains to Support Carriage

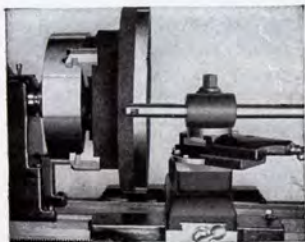


16-24-INCH GENERAL PURPOSE LATHE

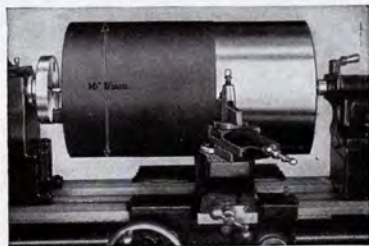
This General Purpose Back Geared Screw Cutting Precision Lathe meets the demand for a lathe with a swing of 24 inches over the bed and 17 inches over the saddle, for taking light and medium cuts on work of large diameter. It is similar to the regular 16-inch lathe (see pages 8 and 9) and is equipped with a special Compound Rest, an extra heavy Saddle, and has Raising Blocks under the headstock and tailstock, to obtain the increased swing.

The 16-24-inch General Purpose Lathe has the advantage over the Gap Lathe in that it permits the increased swing for the entire distance between centers. On the Gap Lathe the increased swing, provided by the gap, is seldom available for chuck work, as the chuck itself often extends the entire distance over the gap.

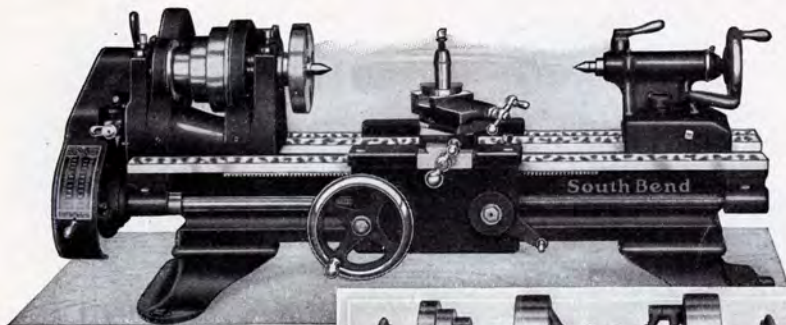
This lathe takes care of a great deal of light machine work of general character that would otherwise require a large and expensive lathe.



Machining Outside Diameter of Balance Wheel, 22-inch Diameter



Machining a Steel Roll 16 Inches in Diameter Between Lathe Centers



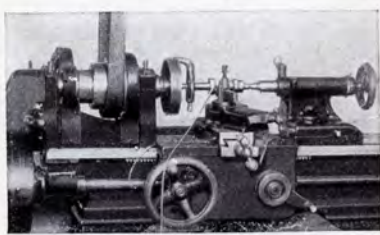
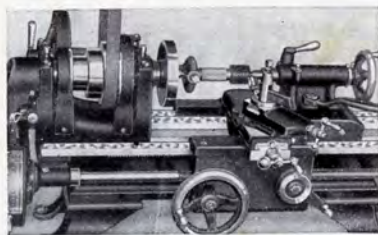
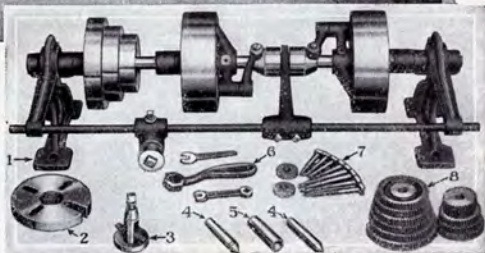
THE 9" JUNIOR BACK GEAR SCREW CUTTING BENCH LATHE

Countershaft Drive

The Bench Lathe is popular in the small shop and in the factory for large production of small parts.

The illustration shows the 9" Junior Bench Lathe with the Countershaft and Equipment. The Junior Lathe is stripped of the automatic friction cross feed and friction longitudinal feed so as to bring the price within the reach of the small shop where these parts are not needed. The large face plate, center rest and follower rest have been omitted from the equipment.

This lathe has power, accuracy and precision. It will cut all standard screw threads, and in addition will machine metals of all kinds such as steel, cast iron, wrought iron, forgings, brass, bronze, etc.

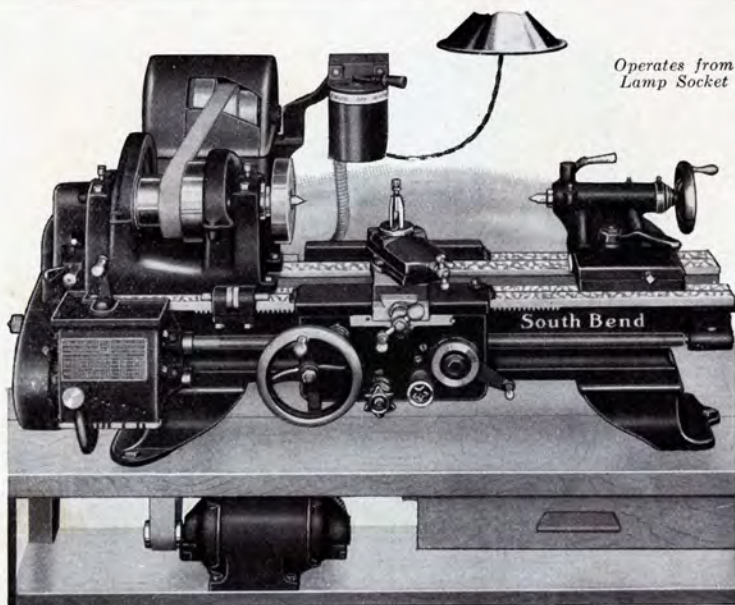


Bench Lathes in Use in a Manufacturing Plant

STANDARD AND QUICK CHANGE BENCH LATHES

Bench Lathes are also made in the 9" and 11" sizes, Quick Change and Standard Change Gear Types. The Bench Lathe is exactly like the floor leg Lathe in every respect except that bench legs have been substituted in place of floor legs.

In addition to the countershaft type of drive Bench Lathes may be driven by the Horizontal Motor Drive and Simplex Motor Drive described on the following pages.



*Operates from
Lamp Socket*

HORIZONTAL MOTOR DRIVE FOR BENCH LATHES

The Horizontal Motor Drive for bench lathes is shown above applied to a 9-inch Quick Change Gear Lathe. The drive cabinet, mounted directly behind the lathe on the bench, contains the jackshaft on which the drive pulley and countershaft cone are attached. The Reversing Motor which rests on a shelf beneath the bench, is connected with the drive pulley by a $1\frac{3}{4}$ -inch leather belt. Another belt, 1-inch wide, transmits power from the countershaft cone to the lathe spindle cone.

A Reversing Switch (drum type) conveniently located within easy reach of the operator, controls the motor and provides instantaneous starting, stopping and reversing of the lathe spindle. The switch has three positions: Left for forward motion of the lathe spindle; Center for stop; and Right for reverse.

The Cabinet Top opens to permit the shifting of the belt. Both the lathe and drive cabinet have three point bearing on bench.

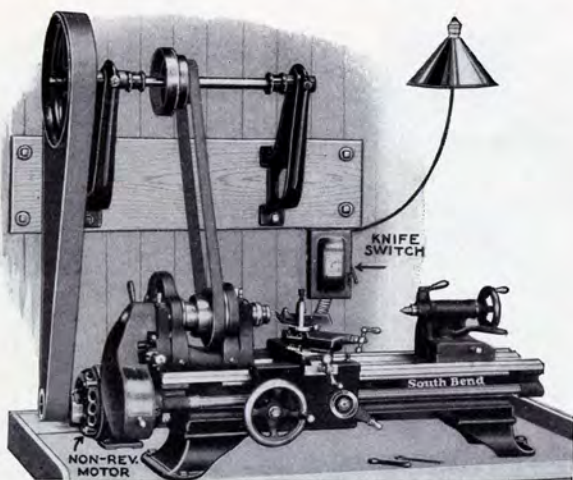
The Horizontal Motor Drive is also practical for the 11-inch Bench Lathe.



View of Motor
Drive Unit



Taking a Chip on a Steel Shaft, in the
9-inch Horizontal Motor Drive Lathe



SIMPLEX MOTOR DRIVE FOR BENCH LATHES

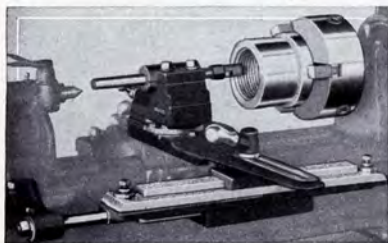
Wall Type Simplex Countershaft Used

The illustration above shows the Simplex Motor Drive for the operation of Bench Lathes. This drive consists of a Simplex Wall Countershaft which is fastened to the wall, and driven by a non-reversing motor mounted on the bench behind the lathe. A knife switch, conveniently located within easy reach of the operator, controls the operation of the motor for starting and stopping the lathe spindle.

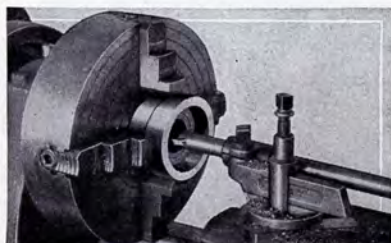
This practical and inexpensive type of drive meets the demand of the small shop that already has a motor of $\frac{1}{4}$ H.P., 1800 R.P.M. non-reversing type.

When ordering a lathe with this drive, the purchaser should specify the speed of his motor so that the correct size of pulley for the countershaft can be supplied with the lathe.

The Simplex Motor Drive method can be applied to 9" and 11" Quick Change Gear or Standard Change Gear Bench Lathes and is practical and efficient for the lathe used for doing small accurate work.



Cutting an Internal Thread on 9" Simplex Motor Drive Lathe



Making a Large Bushing Held in a 4-Jaw Independent Lathe Chuck

CENTERS, DRILL PADS, AND ARBORS

The illustrations show a number of accessories which are very useful for various classes of lathe work. These parts are machined and fitted to both head and tail spindles of the various size lathes.



60-degree Lathe Center



Crotch Center



Screw Drill Chuck



Spur Center



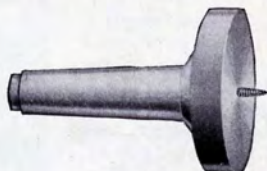
Drill Chuck Arbor



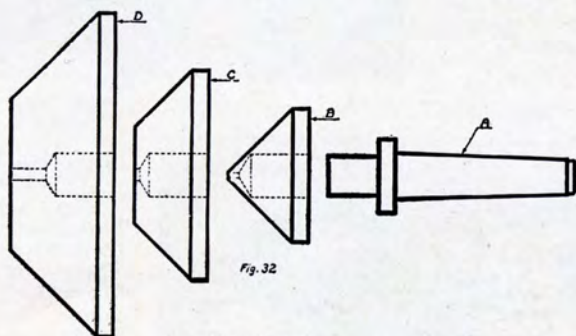
Cup Center



Drill Pad



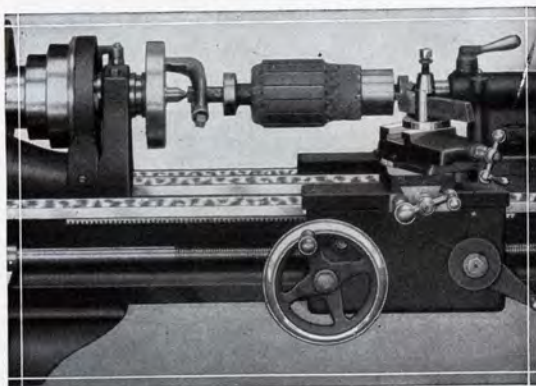
Screw Center



Pipe Centers

The drawing shows a practical pipe center for the engine lathe. The taper shank "A" fits into the head-spindle and tail-stock spindle. The conical discs "B," "C" and "D" fit loosely and revolve on taper shank "A."

THREE PRACTICAL SERVICE JOBS DESCRIBED IN AUTO MECHANIC'S SERVICE BOOK No. 66—See Page 155

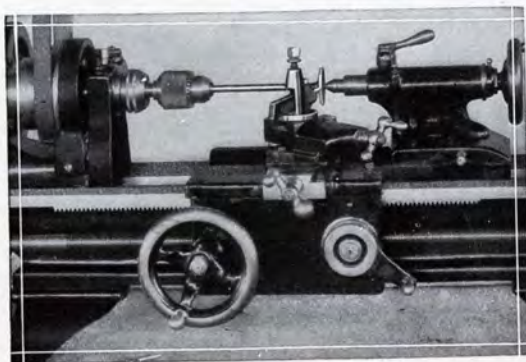
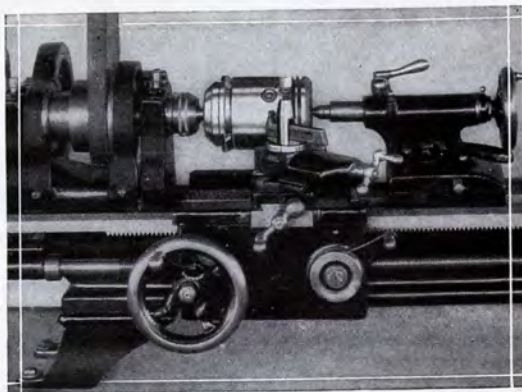


Armature Truing in the Lathe

The Lathe is the practical tool for truing armature commutators and for general machine work in the electrical service station. Machining the commutator smooth and true is a precision job and must be done on a screw cutting Lathe with power feed, if satisfactory results are to be obtained.

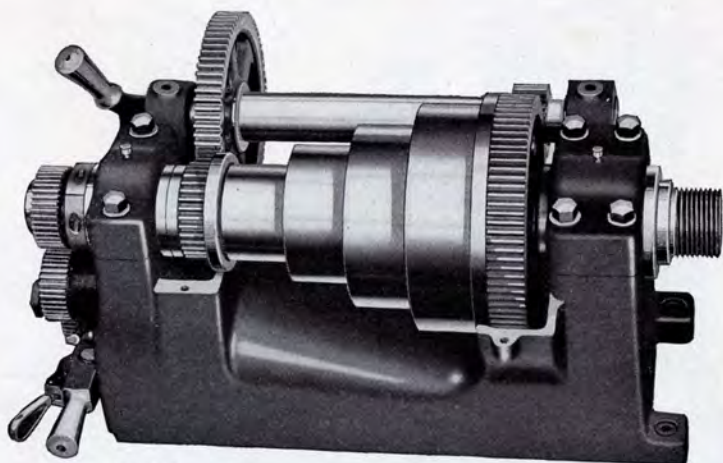
Finish Turning Semi-machined Pistons in the Lathe

The correct way to machine semi-machined pistons is to turn them to finished size in the Lathe instead of grinding, because turning is four times faster and produces just as good a job. The Lathe can be used for hundreds of other jobs.



Refacing Valves in the Lathe

The Screw Cutting Lathe is the ideal tool for refacing Valves by turning, because the Compound Rest of the Lathe can be set to the exact angle desired. The Valve can be refaced by turning four times faster than grinding and yet produce a better job.



Back Geared Headstock of 16-inch South Bend Lathe
with Gear Guards Removed

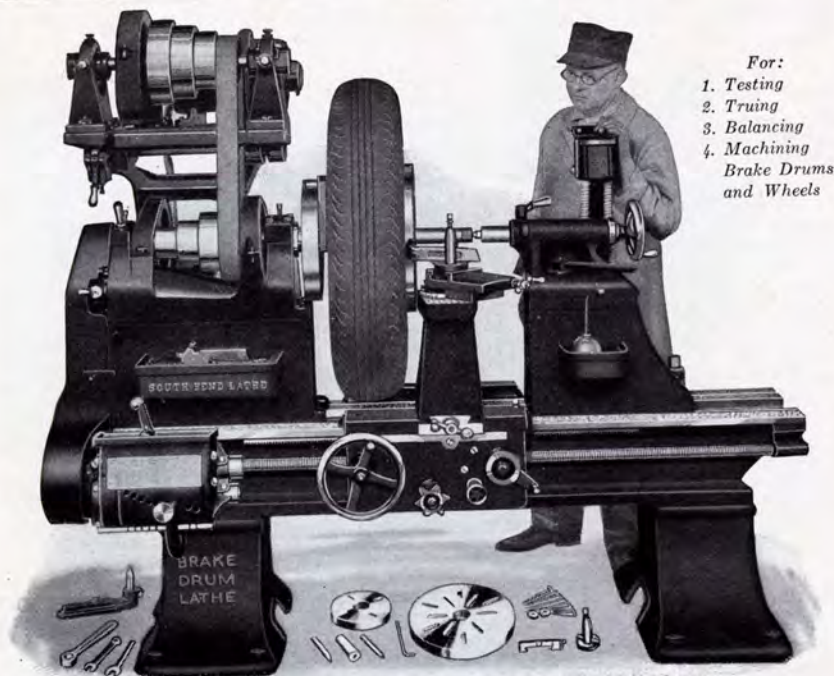
THE SINGLE BACK GEARED AND THE DOUBLE BACK GEARED SCREW CUTTING LATHE

The difference between the Single Back Geared Lathe and the Double Back Geared Lathe is sometimes confusing to the apprentice, as he is liable to get the impression from the name double that the "Double Back Gear" doubles the maximum power of the lathe. The Double Back Gear does not increase the maximum power of the back geared lathe. The double back gear is an additional or an intermediate gear drive of intermediate power between the back gear drive and the direct belt drive.

THE SPINDLE CONE OF BACK GEARED AND DOUBLE BACK GEARED LATHES

The four step spindle cone is used on the South Bend Back Geared Lathes on sizes from 13" to 24" inclusive. Most Double Back Geared Lathes of the above sizes are equipped with a three step cone. The fourth or smallest step of the Back Geared spindle cone is omitted to make room for the double back gear or the intermediate back gear.

The Single Back Geared Lathe from 9" to 18" inclusive, is considered more practical for general machine work than the Double Back Geared Lathe, because of the advantage of the smallest step on the four step cone which is used a great deal on light work, where high speed is necessary. In some shops, the smallest step of the spindle cone is used almost as much as the other three steps combined, especially on the smaller size lathes.



- For:
1. Testing
 2. Truing
 3. Balancing
 4. Machining
Brake Drums
and Wheels

36-inch Silent Chain Motor Driven Brake Drum Lathe

BRAKE DRUM AND WHEEL SERVICE ON THE LATHE

The South Bend Method of truing, testing, balancing and machining brake drums and wheels is scientific in principle. Self-centering mandrels and bearing adapters are used which automatically center the wheel, brake drum and hub, thereby insuring the greatest accuracy on all machining operations.

The Back Geared Screw Cutting Brake Drum Lathe, Silent Chain Motor Drive or Countershaft Drive, is the ideal tool for brake drum and wheel work because this work requires accuracy and precision. This lathe is practical for all of the operations that are necessary when testing and balancing wheels, testing, truing and machining brake drums.

The 36-inch Brake Drum Lathe, illustrated above, is a Back Geared Screw Cutting Precision Lathe which will swing a wheel, with tire attached, up to 36 1/4 inches in diameter. It is designed for truing brake drums, refacing hubs and servicing auto wheels of all types and makes, front and rear, single or dual, which includes the wheels of all pleasure cars, buses and medium size trucks. This lathe will also handle all classes of general machine work, such as cutting screw threads, drilling, boring, facing, turning, chucking, etc.

Two types of drive are available for this lathe, countershaft drive and motor drive. If the shop is equipped with a line shaft, the countershaft drive is more practical. If there is no line shaft, the silent chain motor drive is recommended, as it is a practical and powerful motor drive which eliminates vibration and noise.

SELF-CENTERING MANDREL AND ADAPTER METHOD**For Truing, Testing and Machining Brake Drums and Wheels**

The Self-centering Mandrel and Adapter Method is the correct, accurate and most economical method for truing brake drums, refacing hubs and machining wheels. The wheel mounted on the self-centering mandrel, fitted with adapters, between centers on the lathe permits machining the brake drum concentric with the axis of the hub.

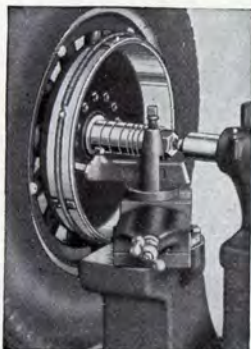
MACHINING JOBS ON THE BRAKE DRUM LATHE

Fig. 628.—Truing an Internal Brake Drum

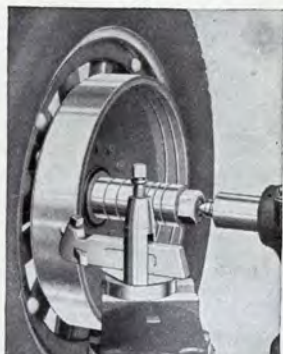


Fig. 629.—Truing an External Band Brake Drum



Fig. 630.—Balancing an Automobile Wheel



Fig. 631.—Boring a Wood Wheel, Mounted in Chuck, for New Hub

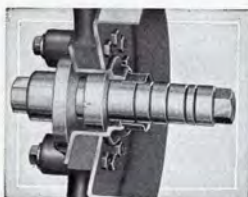


Fig. 632.—The Illustration Shows the Face Plate and Annular Adapter Method of Mounting Rear Wheels Fitted with Annular Ball Bearings



Fig. 633.—Machining Fly-wheel for New Ring Gear by Undercutting Worn Teeth with Parting Tool

MANDREL AND ADAPTER EQUIPMENTS FOR BRAKE DRUM LATHES**Assortment No. 2 for 36" Lathe**

For Servicing the Wheels and Brake Drums of 45 Models of Medium Size Buses, Trucks and Automobiles

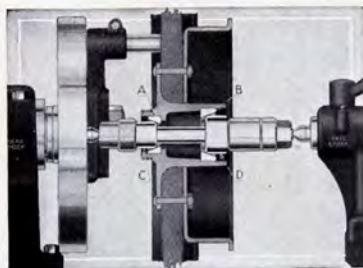
- 1—No. 1822 Taper Mandrel.
- 1—No. 1823 Taper Mandrel.
- 1—No. 1890 Straight Mandrel.
- 8—No. 1891 Universal Bearing Adapters: 1 5/8" dia., 1 7/8" dia., 2" dia., 2 1/4" dia., 2 3/4" dia., 2 1/2" dia., 2 5/8" dia., 2 7/8" dia.

Assortment No. 3 for 42" Lathe

For Servicing the Wheels and Brake Drums of 42 Models of Heavy Buses and Trucks

- 1—No. 1810 Straight Mandrel.
- 1—No. 1840 Straight Mandrel.
- 1—No. 1826 Taper Mandrel.
- 2—No. 1811 Universal Bearing Adapters: 2 1/2" dia., 3" dia., 3 1/2" dia., 4" dia., 4 1/2" dia.

SELF-CENTERING STRAIGHT MANDRELS FOR FRONT WHEELS



Timken Races and Universal Bearing Adapters

A front wheel with Timken roller races, mounted on the mandrel fitted with universal bearing adapters, between centers in the lathe ready for testing or machining.

The self-centering straight mandrel will take care of all front wheels and all three-quarter and full-floating rear wheels (mounted on ball or roller bearings). The mandrel is fitted with adjustable collars, allowing wheels of all widths to be mounted. The threaded nut presses the bearing adapters against the bearing cups of the hub, making it line up accurately.

UNIVERSAL BEARING ADAPTERS

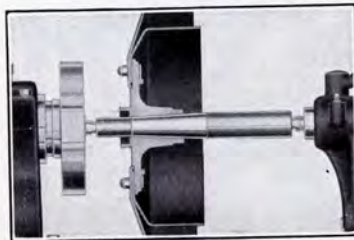


The illustration shows a pair of universal bearing adapters used on self-centering straight mandrels for

mounting all types and makes of front wheels, and rear wheels with three-quarter and full-floating axles. The rounded corner of the adapter conforms to the curve in the ball race cup and also to the angle of the Timken cup.

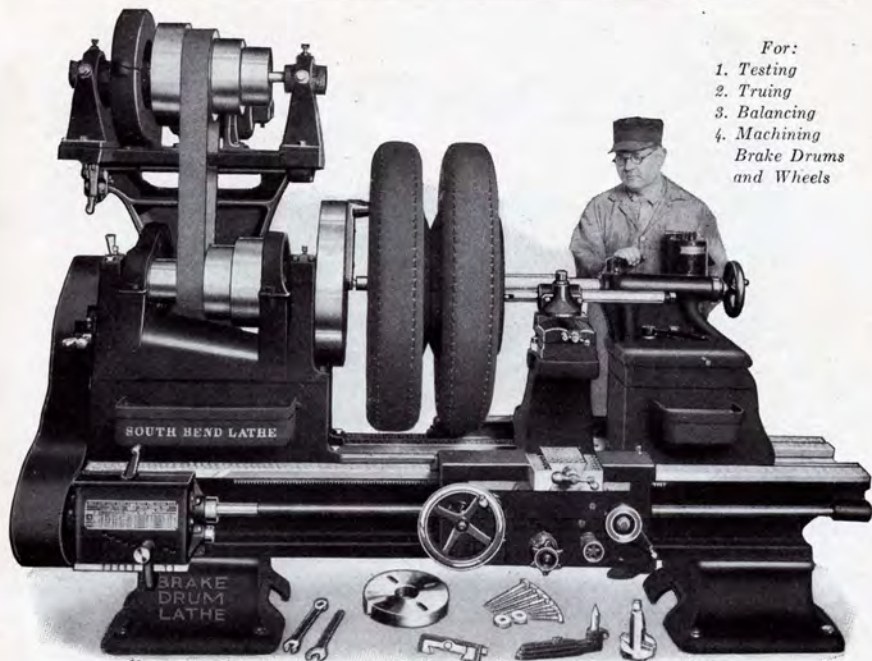
HOW TO MOUNT WHEELS		
TYPE OF WHEEL BEARING	MOUNT WHEEL WITH	
	Mandrel	Adapter
Taper Roller such as Timken (And Ball)	Self-Centering Straight Mandrel	Universal Bearing Adapter
Annular Ball	Same as Above	Annular Adapters Page 133
Semi-Floating Rear Wheels Taper Axle	Taper Mandrel	None Required

SELF-CENTERING TAPER MANDRELS FOR REAR WHEELS



Set up of a rear wheel fitted with a taper mandrel, mounted between centers in the lathe for testing and machining.

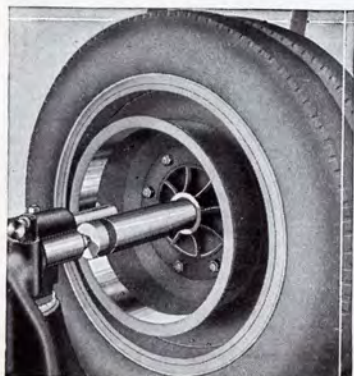
The self-centering taper mandrel, illustrated above, is used for mounting semi-floating rear wheels (mounted on a taper) between centers in the lathe for testing, truing or machining brake drums and wheels. The mandrel fits the taper hole in the hub, as illustrated at left, the same as the axle of the car, and when the wheel is fitted on the taper of the mandrel it will be concentric with the axis of the wheel hub.



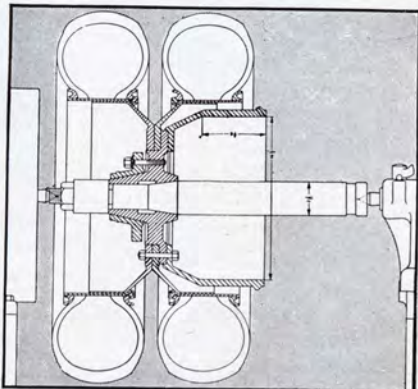
- For:
1. Testing
 2. Truing
 3. Balancing
 4. Machining
Brake Drums
and Wheels

42-INCH BRAKE DRUM MOTOR DRIVEN LATHE

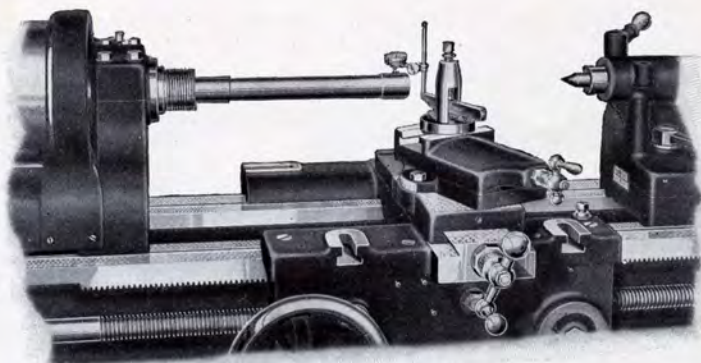
The 42-inch Brake Drum Lathe is practical for the truing of brake drums, refacing hubs, machining flywheels for new ring gears, and servicing wheels of heavy duty trucks, buses and automobiles. It will handle wheels, single or dual, with tire attached, up to 42½ inches in diameter. It is a regular back geared screw cutting lathe, and may be used in the service station shop for all classes of general machine work.



Truing the Brake Drum of a Truck Rear Dual Wheel



Cross Section View of a Truck Rear Dual Wheel Mounted on a Special Mandrel



Testing Headstock Spindle with Test Bar and Test Indicator

THE ACCURACY OF A SCREW CUTTING LATHE

In manufacturing the back geared screw cutting lathe the accuracy of the different parts is given the most careful attention. The methods of insuring accuracy and a few of the accuracy tests are illustrated and described on the following four pages.

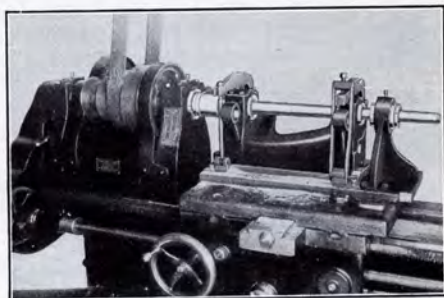
The illustration above shows the method of testing the head stock spindle of a lathe to see that the taper of the spindle runs true and that the axis of the spindle is parallel to the ways of the lathe.

The test bar is made of steel and ranges from 12" to 18" long, depending on the size of the lathe. It is machined between centers and ground on the taper shank and also on the two larger diameters as shown above. An Indicator placed on this bar as shown in the cut can detect an error of one ten-thousandth of an inch.



DIAL TEST INDICATOR

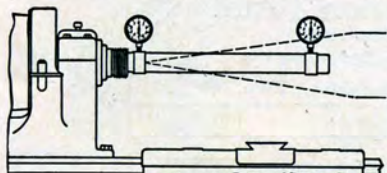
The illustration shows the Dial Test Indicator which is fastened in the lathe tool post. The face of the dial is so graduated that it will record an error of one ten-thousandth of an inch.



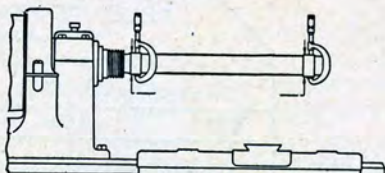
Finish Boring Headstock Spindle Bearings

In testing a lathe for accuracy even when the lathe is being assembled it is necessary that it be leveled carefully, and that the weight of the lathe is distributed equally on the four legs, and that each leg sets firmly on the floor.

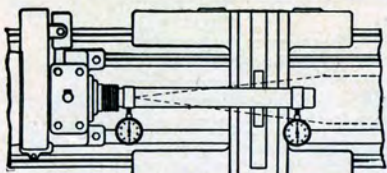
PRECISION ACCURACY TESTS MADE ON THE LATHE



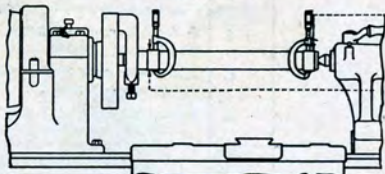
Test 1.—Testing Alignment of Headstock Spindle, in Vertical Plane



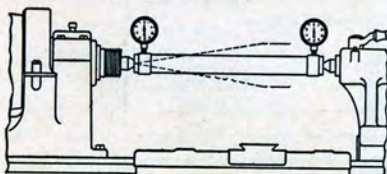
Test 7.—Micrometer Test of Headstock Spindle Alignment



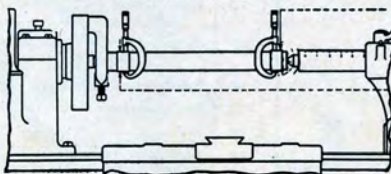
Test 2.—Testing Alignment of Headstock Spindle, in Horizontal Plane



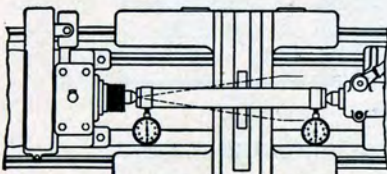
Test 8.—Micrometer Test of Headstock and Tailstock Spindle Alignment



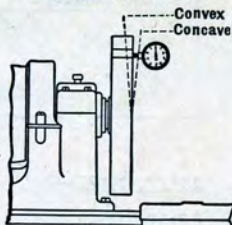
Test 3.—Testing Alignment of Tailstock Spindle with Headstock Spindle, in Vertical Plane



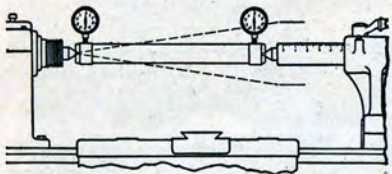
Test 9.—Micrometer Test of Headstock and Tailstock Spindle Alignment. (Tailstock Spindle Extended)



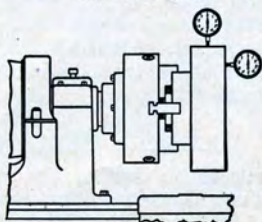
Test 4.—Testing Alignment of Tailstock Spindle with Headstock Spindle, in Horizontal Plane



Test 10.—Saddle Cross Slide Indicator Test on Face Plate Cut



Test 5.—Testing Alignment of Tailstock Spindle with Headstock Spindle, in Vertical Plane. (Tailstock Spindle Extended)



Tests 11 and 12.—Testing Accuracy of Chuck Jaws on Diameter and Face

Test 6 is similar to test 5 but in Horizontal Plane

Maximum Error Allowed on Above Tests is .001". Chucks Are Held to Chuck Manufacturers' Limits, .003".

Factory Precision Tests		
Made on South Bend Lathes		
Be Sure Lathe is Perfectly Level Before Making Tests		
Size of Lathe <u>16" x 8'</u> Catalog No. <u>92-E</u>		
Test No.	DIAL INDICATOR TESTS	Test Record
1.	Testing Alignment of Headstock Spindle, Vertical Plane.....	.0002" High Low In
2.	Testing Alignment of Headstock Spindle, Horizontal Plane.....	.0003" Out
3.	Testing Alignment of Tailstock Spindle With Headstock Spindle, in Vertical Plane.....	.0002" High Low
4.	Testing Alignment of Tailstock Spindle With Headstock Spindle, in Horizontal Plane.....	.0002" In Out
5.	Testing Alignment of Tailstock Spindle with Headstock Spindle in Vertical Plane (Spindle Extended).....	.0003" High Low
6.	Testing Alignment of Tailstock Spindle with Headstock Spindle, in Horizontal Plane (Spindle Extended).....	.0002" In Out
Test No.	TRIAL CUT TESTS WITH LATHE IN OPERATION	Test Record
7.	Micrometer Test of Headstock Spindle Alignment.....	.0006"
8.	Micrometer Test of Headstock and Tailstock Spindle Alignment.....	.0004"
9.	Micrometer Test of Headstock and Tailstock Spindle Alignment (Spindle Extended).....	.0005" Con- cave
10.	Saddle Cross Slide Indicator Test on Face Plate Cut.....	.001"
11.	Testing Accuracy of Chuck Jaws on Diameter.....	.0015"
12.	Testing Accuracy of Chuck Jaws on Face.....	.002"
13.	Lead Screw Final Lead Test.....	O.K.
14.	Saddle Bearing on Cross Slide.....	O.K.
	Saddle Bearing on Lathe Bed.....	O.K.
15.	Countershaft Clutch Test.....	O.K.
Assembled By <u>H. J. Gremert</u> Date <u>3-14-30</u>		
Tested By <u>R. S. Young</u> Date <u>3-14-30</u>		
SOUTH BEND LATHE WORKS		

Fig. 522

FACTORY TEST CARD OF FINISHED LATHE

The Factory Test Card illustrated above shows a record of some of the principal tests that are made on each back geared screw cutting precision lathe. A few of these tests are shown on pages 136 and 137.

Fifteen final major tests, as indicated on the Factory Test Card above, are made just before the lathe leaves the factory. A complete record of these tests is kept on file in the office of the manufacturer for future reference.

ACCURACY TESTS OF LATHE INSURE PRECISION

Each lathe during the process of manufacturing and assembling undergoes sixty-four important accuracy tests with precision instruments. For example: When boring headstock bearings, every alternate headstock is tested as it comes from the boring machine to see that it is bored accurately. Similar tests are made on the tailstock, carriage and saddle, etc.

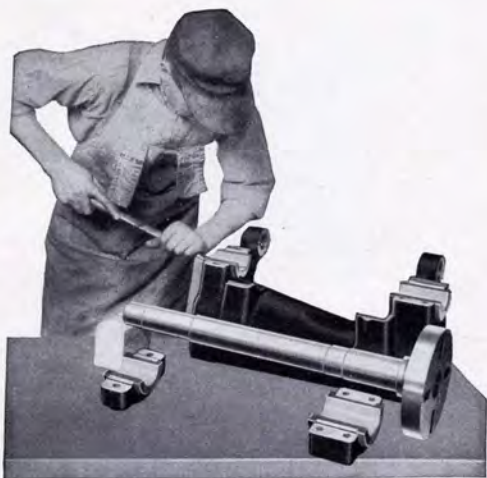


HAND SCRAPING THE WAYS OF A LATHE BED

After a lathe bed has been machined it is thoroughly seasoned, then finish planed. Extreme accuracy is obtained by scraping the ways by hand, so all South Bend Lathe Beds are hand finished and frosted by master craftsmen preparatory to the fitting of the carriage, headstock and tailstock.

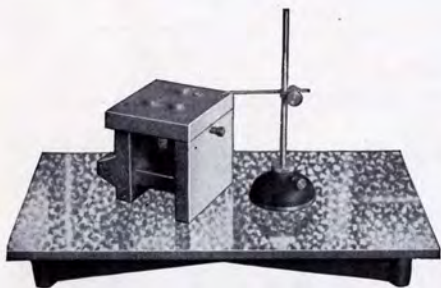
FITTING THE BRONZE SPINDLE BEARINGS

The Bronze Bearings for the spindle are machined all over and are hand fitted to the housings of the headstock. The spindle being finished ground, is placed in the bronze bearings and turned by hand. The prussian blue on the spindle will mark the high points of the bronze bearings for hand scraping. The scraping of these bearings to a perfect fit requires great skill.

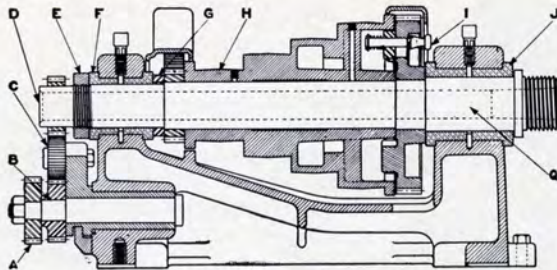


HAND SCRAPING ON MACHINE PARTS

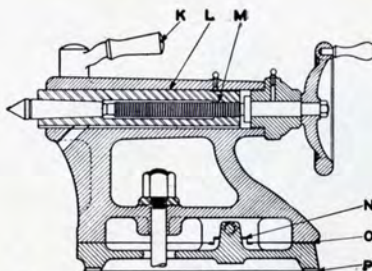
The accuracy and precision of a fine piece of machinery depends upon the fit of the bearings. Sliding surfaces must be hand scraped and also the important cylindrical bearings.



The surface plate, shown in the illustration, is used in the building of fine machinery to test plane surfaces while hand scraping. Two surface plates are necessary so that they may be tested together occasionally and the surface kept perfectly true and flat.



Cross Section of a Lathe Headstock



Cross Section of a Lathe Tailstock

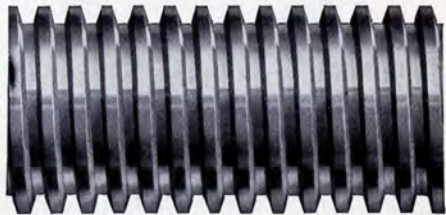


Graduated Tailstock Spindle

Principal Parts of Headstock and Tailstock on a Back Geared Screw Cutting Lathe

- | | |
|---|---|
| A—Steel Stud Gear | J—Phosphor Bronze Bearings |
| B—Extra Long Reverse Shaft | K—Improved Tail Spindle Lock |
| C—Quick Acting Reverse. All Gears Steel | L—Steel Tailstock Spindle |
| D—Hole Through Headstock Spindle | M—Acme Thread Tailstock Screw |
| E—Take-up Nut for End Play | N—Set-over for Taper Turning |
| F—Bronze Spindle Bearings | O—Tailstock Top Accurately Hand Scraped to Base |
| G—Hardened, Ground Steel Thrust Collar | P—Tailstock Base Hand Scraped to Bed |
| H—Balanced Cone Pulley | Q—Special Carbon Steel Hollow Spindle |
| I—Wrenchless Bull Gear Clamp | |

The illustration shows a section of the lead screw for the Lathe. These lead screws are made of a special steel, have a coarse pitch Acme thread and are cut with precision accuracy, on a special machine equipped with a master lead screw which insures accuracy.



Section of Lead Screw Used on the 16-inch Lathe. Actual Size $1\frac{1}{8}$ Inches in Diam., 6 Pitch

PRISMATIC "V" WAYS OF THE LATHE BED



End View of Lathe Bed Showing Prismatic "V" Ways

The modern Back Geared Screw Cutting Precision Lathe is fitted with three Prismatic "V" ways, as illustrated in the cut herewith. This is a photograph of the end view of a lathe bed, showing the "V" ways. From right to left, numbers 1, 3 and 4 are Prismatic "V" ways. Number 2 is a Flat way. The headstock and tailstock of the lathe are aligned on the bed by the number 3 Prismatic "V" way, and supported by the Flat way. The carriage is aligned by the two outer "V" ways, Nos. 1 and 4, which are parallel with No. 3.

BED CONSTRUCTION

The section of the bed illustrated above shows one of the many connecting cross box ribs that will be found throughout the bed at intervals of from 16 inches to 24 inches, depending on the size and length of the bed. These box ribs are to strengthen the bed. A number of them are cast in at short intervals throughout the bed.

The lathe bed is of cast iron containing about 18 per cent steel. As the bed comes from the foundry it is rough machined and then set aside and thoroughly seasoned. Then the bed is finish machined, hand scraped and assembled with the proper units.

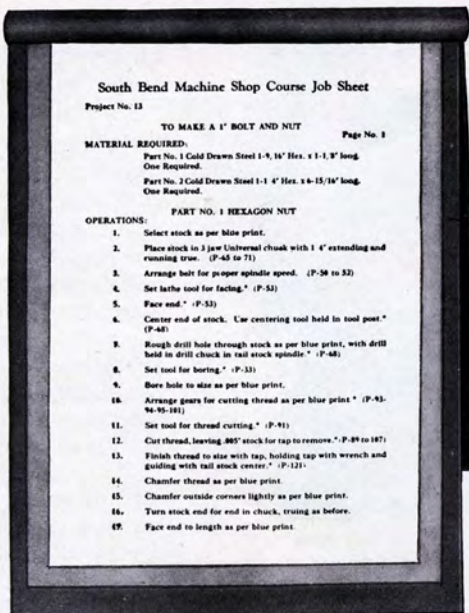
SERIAL NUMBER OF LATHE

Each bed is marked with a serial number. (See above.) This number will be found on the tailstock end of the bed between the number 1 "V" way and the Flat way. Should repairs or attachments be required for the lathe, even though years after its purchase, the correct repair parts or attachments can be obtained by mentioning the serial number and the size and type of lathe on which they are to be used.

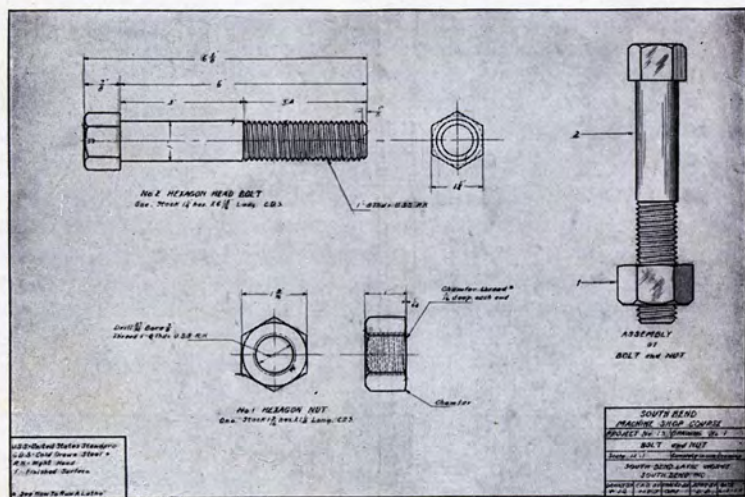
KEEP THE LEAD SCREW CLEAN

All dirt and dust should be removed from the Lead Screw at least once a month. A good way to do this is to take a stiff brush, dip it in gasoline and brush the Lead Screw while it is slowly revolving.

South Bend Machine Shop Course



SAMPLE JOB SHEET (Actual Size 8 1/2" x 14") FOR PROJECTS



SAMPLE BLUE PRINT (Actual Size 12" x 18") FOR PROJECTS

South Bend Machine Shop Course

For Machinist Apprentices

The South Bend Machine Shop Course consists of 52 practical projects covering the fundamental operations of modern machine shop practice. The Course is based on production methods used in the building of machinery in industry. Job Sheets (8½"x14") and Blue Prints (12"x18") have been worked out and are furnished for each Project.

COPIES OF DRAWINGS AND JOB SHEETS

Shop Instructors desiring to duplicate the Blue Prints or Job Sheets may do so. Additional copies prove valuable for lecture work, with them the Instructor is able to impart information to the class instead of to the individual.

ROUGH CASTINGS FOR PROJECTS

If you are unable to obtain castings for projects in your locality we can supply them at the prices shown in Bulletin No. 55. If you are not equipped for doing planer work on projects we can do it for you charging only the actual expense incurred.

52 PRACTICAL PROJECTS

The 52 Projects in the Course cover a wide range of machine shop work starting with simple elementary jobs and gradually advancing so that the more advanced projects require skill equal to that of the expert mechanic.

We list below a few of the 52 projects:

- | | |
|------------------------------|-------------------------------------|
| No. | No. |
| 13. 1" Bolt and Nut | 6. 60 degree Lathe Centers |
| 39. Small Bench Vise | 68. 8" Bench Lathe for Wood Turning |
| 44. Jack Screw, heavy duty | 70. ¼ H.P. Gasoline Engine |
| 29. Boring Bar for the Lathe | 31. Morse Taper Standard Test Plug |
| 7. Drill Chuck Arbor | 56. Draw-in Chuck Attachment |
| 10. Blacksmith Drill Chuck | 66. 8-inch Emery Grinder |
| 20. Machinist's Clamp | |

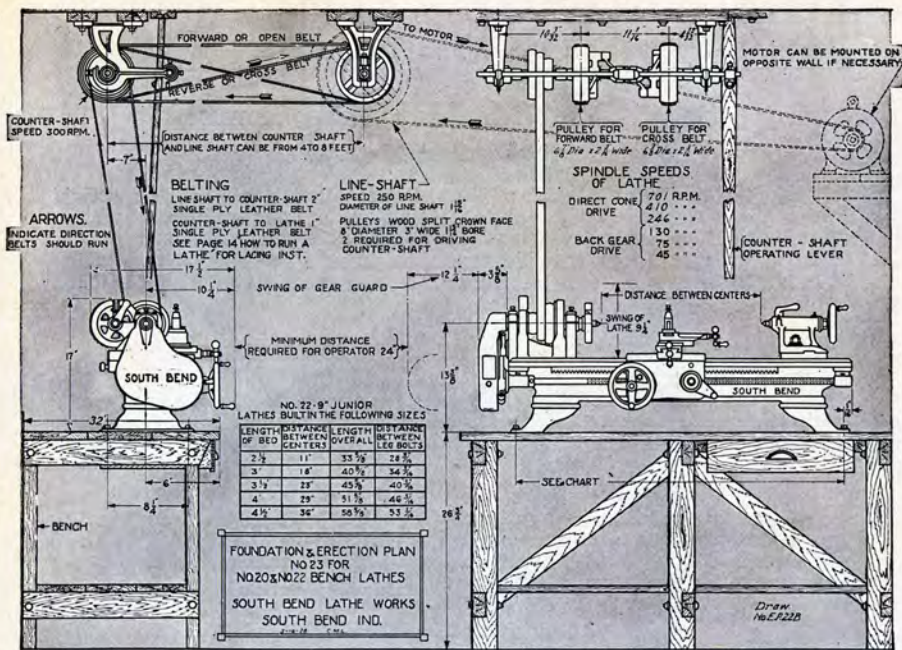
Educators in foreign countries as well as those in the United States have shown much interest in this Machine Shop Course. At the present time there are over 5000 schools and shops using the course.



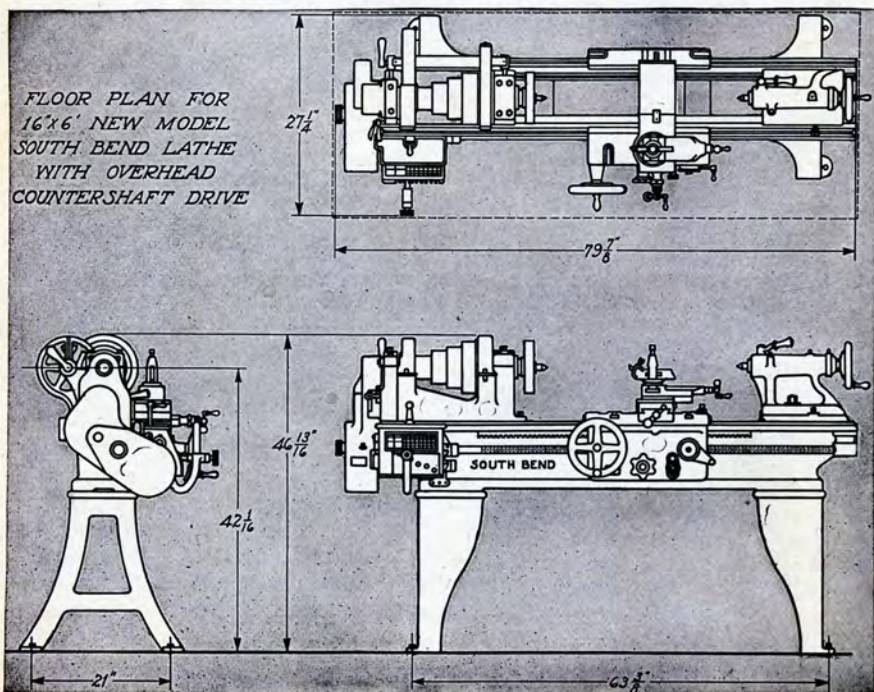
BULLETIN NO. 55

The South Bend Machine Shop Course

This 16-page Bulletin gives complete detailed information on the South Bend Machine Shop Course and prices of the Projects, Rough Castings, Steel and Hardware parts. The Booklet will be mailed post-paid, no charge, to any supervisor, professor or instructor on request.



ERECTION PLAN FOR BENCH LATHES



FOUNDATION PLAN FOR LATHES

DON'TS FOR MACHINISTS**From "Machinery"**

- Don't run a lathe with the belt too loose.
- Don't run the point of your lathe tool into the mandrel.
- Don't rap the chips out of your file on the lathe shears.
- Don't set a lathe tool below the center for external work.
- Don't start up a lathe without seeing that the tail stock spindle is locked.
- Don't put an arbor or shaft on lathe centers without lubricant on them.
- Don't leave too much stock on a piece of work to take off with the finishing cut.
- Don't try a steel gauge or an expensive caliper on a shaft while it is running.
- Don't put a mandrel into a newly bored hole without a lubricant of some kind on it.
- Don't put a piece of work on centers unless you know that the internal centers are clean.
- Don't try to straighten a shaft on lathe centers, and expect that the centers will run true afterwards.
- Don't put a piece of work on lathe centers unless you know that all your centers are at the same angles.
- Don't take a lathe center out of its socket without having a witness mark on it, and put it back again according to the mark.
- Don't start polishing a shaft on lathe centers without having it loose enough to allow for the expansion by heat from the polishing process.
- Don't run your lathe tool into the faceplate.
- Don't try to knurl a piece of work without oiling it.
- Don't run a lathe an instant after the center begins to squeal.
- Don't forget to oil your machine every morning; it works better.
- Don't forget that a fairly good center-punch may be made from a piece of round file.
- Don't forget that a surface polished with oil will keep clean much longer than one polished dry.
- Don't start to turn up a job on lathe centers unless you know that the centers are both in line with the ways.
- Don't cross your belt laces on the side next the pulley, for that makes them cut themselves in two.
- Don't try to cut threads on steel or wrought iron dry; use lard oil or a cutting compound.
- Don't run a chuck or faceplate up to the shoulder suddenly; it strains the spindle and threads and makes removal difficult.
- Don't screw a tool post screw any tighter than is absolutely necessary; many mechanics have a false idea as to how tight a lathe tool should be to do its work.
- To drive the center out of head spindle use a rod and drive through the hole in spindle.
- When putting a lathe chuck on the head spindle, always remove the center.
- When the center is removed from the head spindle of the lathe, always put a piece of rag in spindle hole to prevent any dirt from collecting.

USE LEATHER BELT ON A LATHE

Leather belts are more practical for a lathe than canvas or rubber belts. They are more efficient, last longer, give better service and permit the lathe to do finer and more accurate work.

The smooth side of the leather belt should be next to the pulley. For a lathe 13 inches or larger, a double ply leather belt is preferred to the single ply. When cutting the end of the belt use a steel square for marking so that you will get an even and straight cut. Punch the lace holes in alignment so that each hole will carry its proportion of the total load.

A belt should not be put on too tightly. All that is needed is enough power to grip the pulleys. When a leather belt is in use do not permit the edges of the belt to rub on any surface. If the pulleys are out of line see that they are adjusted properly. If a belt has a tendency to come off from the pulley there is something wrong. Find out what the trouble is and remedy it. Do not try to hold it on the pulley with a wooden brace or guard.

A belt should not be allowed to come in contact with mineral oil because it tends to heat and crack the belt, and permits slippage. If a belt becomes somewhat dry it should be oiled with neatsfoot oil.

[See Page 16]

RULES RELATIVE TO THE CIRCLE AND SPHERE

To find the circumference of a circle, multiply the diameter by 3.1416.

To find the diameter of a circle, multiply the circumference by .31831.

To find the area of a circle, multiply the square of the diameter by .7854.

To find the surface of a ball (sphere), multiply the square of the diameter by 3.1416.

To find the side of an equal square, multiply the diameter by .8862.

To find the cubical content (volume) in a ball, multiply the cube of the diameter by .5236.

The radius of a circle $\times 6.283185 =$ circumference.

The square of the diameter of a circle $\times .7854 =$ the area.

The square of the circumference of a circle $\times .07958 =$ the area.

Circumference of a circle \times one-fourth its diameter $=$ the area.

The circumference of a circle $\times .159155 =$ the radius.

The square root of the area of a circle $\times .56419 =$ the radius.

The square root of the area of a circle $\times 1.12838 =$ the diameter.

A gallon of water (U. S. Standard) weighs $8\frac{1}{2}$ pounds and contains 231 cubic inches. A cubic foot of water contains $7\frac{1}{2}$ gallons, 1728 cubic inches, and weighs $62\frac{1}{2}$ pounds at a temperature of about 39 degrees Fahrenheit. The weight changes slightly above and below this temperature.

To find the pressure in pounds per square inch of a column of water, multiply the height of the column in feet by .433.

Steam rising from water at its boiling point (212 degrees F.) has a pressure equal to that of the atmosphere at sea level (14.7 pounds per square inch).

Doubling the diameter of a pipe increases its capacity four times.

TABLE OF DECIMAL EQUIVALENTS
of 8ths, 16ths, 32nds and 64ths of an inch

8ths.	16ths.	32nds.	
$\frac{1}{8}$ = .125	$\frac{1}{16}$ = .0625	$\frac{1}{32}$ = .03125	$\frac{1}{64}$ = .015625
$\frac{2}{8}$ = .250	$\frac{2}{16}$ = .125	$\frac{2}{32}$ = .0625	$\frac{2}{64}$ = .03125
$\frac{3}{8}$ = .375	$\frac{3}{16}$ = .1875	$\frac{3}{32}$ = .09375	$\frac{3}{64}$ = .046875
$\frac{4}{8}$ = .500	$\frac{4}{16}$ = .250	$\frac{4}{32}$ = .125	$\frac{4}{64}$ = .0625
$\frac{5}{8}$ = .625	$\frac{5}{16}$ = .3125	$\frac{5}{32}$ = .15625	$\frac{5}{64}$ = .078125
$\frac{6}{8}$ = .750	$\frac{6}{16}$ = .375	$\frac{6}{32}$ = .1875	$\frac{6}{64}$ = .09375
$\frac{7}{8}$ = .875	$\frac{7}{16}$ = .4375	$\frac{7}{32}$ = .21875	$\frac{7}{64}$ = .109375
	$\frac{8}{16}$ = .500	$\frac{8}{32}$ = .250	$\frac{8}{64}$ = .125
	$\frac{9}{16}$ = .5625	$\frac{9}{32}$ = .28125	$\frac{9}{64}$ = .140625
	$\frac{10}{16}$ = .625	$\frac{10}{32}$ = .3125	$\frac{10}{64}$ = .15625
	$\frac{11}{16}$ = .6875	$\frac{11}{32}$ = .34375	$\frac{11}{64}$ = .171875
	$\frac{12}{16}$ = .750	$\frac{12}{32}$ = .375	$\frac{12}{64}$ = .1875
	$\frac{13}{16}$ = .8125	$\frac{13}{32}$ = .40625	$\frac{13}{64}$ = .203125
	$\frac{14}{16}$ = .875	$\frac{14}{32}$ = .4375	$\frac{14}{64}$ = .21875
	$\frac{15}{16}$ = .9375	$\frac{15}{32}$ = .46875	$\frac{15}{64}$ = .234375
		$\frac{16}{32}$ = .500	$\frac{16}{64}$ = .250

64ths

$\frac{1}{64}$ = .015625	$\frac{17}{64}$ = .265625	$\frac{33}{64}$ = .515625	$\frac{49}{64}$ = .765625
$\frac{2}{64}$ = .03125	$\frac{18}{64}$ = .28125	$\frac{34}{64}$ = .53125	$\frac{50}{64}$ = .78125
$\frac{3}{64}$ = .046875	$\frac{19}{64}$ = .296875	$\frac{35}{64}$ = .546875	$\frac{51}{64}$ = .796875
$\frac{4}{64}$ = .0625	$\frac{20}{64}$ = .3125	$\frac{36}{64}$ = .5625	$\frac{52}{64}$ = .8125
$\frac{5}{64}$ = .078125	$\frac{21}{64}$ = .328125	$\frac{37}{64}$ = .578125	$\frac{53}{64}$ = .828125
$\frac{6}{64}$ = .09375	$\frac{22}{64}$ = .34375	$\frac{38}{64}$ = .59375	$\frac{54}{64}$ = .84375
$\frac{7}{64}$ = .109375	$\frac{23}{64}$ = .359375	$\frac{39}{64}$ = .609375	$\frac{55}{64}$ = .859375
$\frac{8}{64}$ = .125	$\frac{24}{64}$ = .375	$\frac{40}{64}$ = .625	$\frac{56}{64}$ = .875
$\frac{9}{64}$ = .140625	$\frac{25}{64}$ = .390625	$\frac{41}{64}$ = .640625	$\frac{57}{64}$ = .890625
$\frac{10}{64}$ = .15625	$\frac{26}{64}$ = .40625	$\frac{42}{64}$ = .65625	$\frac{58}{64}$ = .90625
$\frac{11}{64}$ = .171875	$\frac{27}{64}$ = .421875	$\frac{43}{64}$ = .671875	$\frac{59}{64}$ = .921875
$\frac{12}{64}$ = .1875	$\frac{28}{64}$ = .4375	$\frac{44}{64}$ = .6875	$\frac{60}{64}$ = .9375
$\frac{13}{64}$ = .203125	$\frac{29}{64}$ = .453125	$\frac{45}{64}$ = .703125	$\frac{61}{64}$ = .953125
$\frac{14}{64}$ = .21875	$\frac{30}{64}$ = .46875	$\frac{46}{64}$ = .71875	$\frac{62}{64}$ = .96875
$\frac{15}{64}$ = .234375	$\frac{31}{64}$ = .484375	$\frac{47}{64}$ = .734375	$\frac{63}{64}$ = .984375

TABLE OF METRIC LINEAR MEASURE

10 Millimeters = 1 Centimeter
10 Centimeters = 1 Decimeter
10 Decimeters = 1 Meter
1 Centimeter = .3937 inch
1 Decimeter = 3.937 inches
1 Meter = 39.37 inches



METRIC AND ENGLISH LINEAR MEASURE

The measuring rule herewith is graduated, one edge in the Metric system and the other edge in the English system. This shows at a glance the comparison of the fractions of the Metric and English units, the meter and the inch.

Equivalents of Millimeters in Decimals of Inches

$\frac{1}{10}$ mm = .00394"	8 mm = .31496"	18 mm = .70866"
$\frac{1}{8}$ mm = .00787"	9 mm = .35433"	19 mm = .74803"
$\frac{1}{4}$ mm = .01969"	10 mm = .39370"	20 mm = .78740"
1 mm = .03937"	11 mm = .43307"	21 mm = .82677"
2 mm = .07874"	12 mm = .47244"	22 mm = .86614"
3 mm = .11811"	13 mm = .51181"	23 mm = .90551"
4 mm = .15748"	14 mm = .55118"	24 mm = .94488"
5 mm = .19685"	15 mm = .59055"	25 mm = .98425"
6 mm = .23622"	16 mm = .62992"	26 mm = 1.02362"
7 mm = .27559"	17 mm = .66929"	

INFORMATION ON GEARS

Diameter, when applied to gears, is always understood to mean the pitch diameter.

Diametral Pitch is the number of teeth to each inch of the pitch diameter.

Example: If a gear has 40 teeth and the pitch diameter is 4 inches, there are 10 teeth to each inch of the pitch diameter and the diametral pitch is 10, or in other words, the gear is 10 diametral pitch.

Number of Teeth required, pitch diameter and diametral pitch given. Multiply the pitch diameter by the diametral pitch.

Example: If the diameter of the pitch circle is 10 inches and the diametral pitch is 4, multiply 10 by 4 and the product, 40, will be the number of teeth in the gear.

Number of Teeth required, outside diameter and diametral pitch given. Multiply the outside diameter by the diametral pitch and subtract 2.

Example: If the whole diameter is $10\frac{1}{2}$ and the diametral pitch is 4, multiply $10\frac{1}{2}$ by 4 and the product, 42, less 2, or 40, is the number of teeth.

Pitch Diameter required, number of teeth and diametral pitch given. Divide the number of teeth by the diametral pitch.

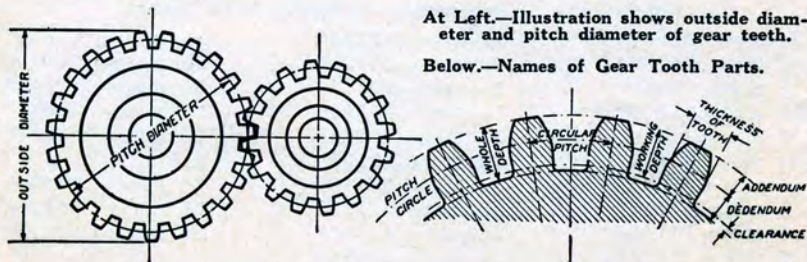
Example: If the number of teeth is 40 and the diametral pitch is 4, divide 40 by 4, and the quotient, 10, is the pitch diameter.

Outside Diameter or size of gear blank required, number of teeth and diametral pitch given. Add 2 to the number of teeth and divide by the diametral pitch.

Example: If the number of teeth is 40 and the diametral pitch is 4, add 2 to the 40, making 42, and divide by 4; the quotient, $10\frac{1}{2}$, is the whole diameter of gear or blank.

Distance Between Centers of two gears required. Add the number of teeth together and divide one-half the sum by the diametral pitch.

Example: If the two gears have 50 and 30 teeth respectively, and are 5 pitch, add 50 and 30, making 80, divide by 2, and then divide the quotient, 40, by the diametral pitch, 5, and the result, 8 inches, is the center distance.



SIZE OF LATHE FOR YOUR WORK

When selecting the size of Lathe for your work, take into consideration the largest diameter and the greatest length of the work which will be done in the lathe. Then select the Lathe that has a swing over bed and distance between centers at least 10% greater than the dimensions of the largest work to be handled.

COUNTERSHAFT OR MOTOR DRIVE FOR A LATHE

The overhead countershaft drive is used principally in factory and production work, where countershaft driven lathes are operated from a lineshaft which is motor driven. In the shop where there is no lineshaft, the motor drive lathe is more practical and efficient and less expensive because a smaller motor can be used and the cost of installing hangers, lineshafting, etc., is eliminated.

The types of lathes for general manufacturing and industrial work are: Countershaft Driven Lathes, Motor Driven Lathes, Quick Change Gear Lathes, Tool Room Lathes, Gap Bed Lathes and Bench Lathes.

THE SPLINED LEAD SCREW AUTOMATIC FEED

For Operating the Automatic Friction Cross and Longitudinal Feeds

The splined lead screw on the Screw Cutting Lathe has an advantage over the rod feed in operating both the automatic cross and longitudinal friction feeds. The lead screw is larger in diameter therefore transmits a powerful and positive geared feed, because it drives the worm through a spline and key. This worm operates the worm wheel in the apron which in turn drives the apron through a rack and pinion. In this manner the splined screw feed drive eliminates the delicate mechanism in the apron which is sometimes used to operate the rod feed.

The threads of the lead screw are not used for driving the automatic cross feed or longitudinal feed. Therefore, the threads of the lead screw are used only when the half nuts are clamped to it for the cutting of screw threads. As there is no wear on the threads of the lead screw except when cutting screw threads, the lead screw should last a life-time.

SILENT CHAIN MOTOR DRIVE LATHES

A Practical Drive for a Back Geared Screw Cutting Lathe.

There have been a great many types of motor drives developed for the operation of the back geared screw cutting lathe. The Silent Chain Motor Drive, shown on pages 122 and 123, was designed in the shops of the General Electric Company, and is used in their tool rooms and production departments for the operation of the back geared screw cutting lathe. It has many unique features, and is considered the most practical motor drive for a back geared screw cutting lathe.

The motor and the countershaft of the lathe are balanced and stand directly over the lathe so that it is impossible for any dirt or chips from the work to drop into the operating mechanical parts of this drive. General Electric motors and Westinghouse Electric motors are used in connection with the Silent Chain Motor Drive. We recommend that these motors be of the reversing type and that a six pole drum type reversing switch be used.

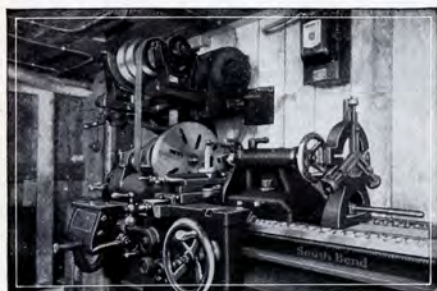
LATHES USED BY BYRD SOUTH POLAR EXPEDITION

On Aug. 26, 1928, Commander Richard E. Byrd's expedition started from New York for the South Pole for the purpose of investigating and recording scientific data. After two successful years in these antarctic regions he returned in June, 1930.

Byrd and his associates recognized the necessity of the back geared screw cutting lathe for maintenance and repair work when making preparations for the journey. Two back geared screw cutting lathes were taken along



Commander Byrd's base ship "City of New York" in New York Harbor just prior to sailing for the Antarctic



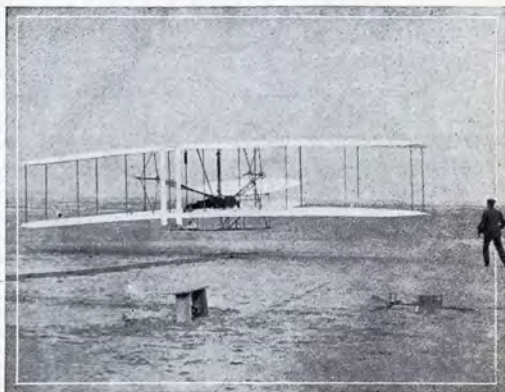
The 16-inch Back Geared Screw Cutting Motor Driven Lathe, ready for operation in the ship "City of New York"

—a 16-inch lathe was used on the base ship, "City of New York," while a 9-inch lathe was used at the various temporary bases set up on the ice to service the planes and other equipment. With these lathes mechanics were able to take care of the numerous mechanical devices, instruments, engines, airplanes, etc.

Today the lathe is the most widely used machine in plants manufacturing airplanes because it is recognized as the precision tool of industry.

THE WRIGHT BROTHERS' FIRST FLIGHT

The illustration at the right shows the first airplane invented and built by Orville and Wilbur Wright of Dayton, Ohio, which was flown for the first time in 1903 at Kitty Hawk, North Carolina. The precision parts of this motor and plane required the utmost in accuracy and workmanship. A back geared screw cutting lathe was used for this work.



The first motor-powered airplane being flown by the Wright Brothers at Kitty Hawk, North Carolina

Breves informes Sobre El Torno South Bend de nuevo modelo y la fábrica en donde se construye

El Torno South Bend de 1930. Modelo Nuevo, con engranajes de dobles velocidades, para filetear que se ilustra y describe en este catálogo está diseñado para la maquinación de metales en las fábricas y los talleres de reparaciones. Recomendamos el Torno South Bend de Nuevo Modelo para los talleres en donde se hacen piezas de precisión, calibres, dados maestros y terrajas, así como para las plantas manufactureras en donde se requiere la mayor velocidad, precisión y comodidad.

Los Tornos de Nuevo Modelo se fabrican en nueve distintos tamaños y siete estilos. Cualquier tamaño o tipo de torno puede ser equipado con herramientas y aditamentos especiales para permitir el desempeño de todos los trabajos de producción y reparaciones que se presentan en el taller moderno. Los Tornos South Bend de Nuevo Modelo son muy populares en las fábricas más importantes de los Estados Unidos, y se usan en grupos de dos a cincuenta en cada taller. En la cubierta de atrás aparecen los nombres de unas cuantas de las más famosas empresas que usan Tornos South Bend.

Historia. La Casa South Bend Lathe Works fue establecida en South Bend, Indiana, E.U.A., en 1906 y desde esa fecha ha operado continuamente por 24 años bajo la misma dirección, dedicándose todo el tiempo a la fabricación de tornos South Bend para cortar tornillos con engranajes de dobles velocidades.

Capacidad. La capacidad de nuestros talleres para la fabricación de tornos nos permite fabricar cinco mil tornos South Bend cada año. La fábrica ocupa un terreno de cuatro acres (1.62 hectárea). Los edificios contienen un espacio de 1722 metros cuadrados que se usa enteramente para la producción de estos tornos modernos.

Geschichte von die Neues Modell South Bend Drehbank und Werkzeugraum wo es gemacht ist.

Die 1930 Neues Modell South Bend Leitspindel Drehbank mit Raedervorgelege illustriert und beschrieben in diesem Katalog, ist fuer die Bearbeitung von Metallen in Industriellen Anlagen und Fabriken entworfen. Wir empfehlen die Neues Modell Leitspindel Drehbank fuer den Werkzeugraum um Werkzeuge, Messgeraete, Innengewindestahle, u.s.w. zu machen, bei denen die groesste Genauigkeit erforderlich ist, und auch fuer die Maschinenfabrik fuer Fabrikationsarbeit, wo es line ideale Drehbank ist, wen schnelligkeit, Genauigkeit und Sparsamkeit in besonderen Betracht kommen.

Die Neues Modell Drehbaenke sind in Neuen Grossen und Sieben verschiedenen Entwuerfen gebaut. Alle Grossen und Entwuerfe koennen mit Werkzeugen und Zubehoertheilen fuer Maschinen und Werkzeugfabrikation versehen werden, um den Anspruechen der modernen Fabrik zu genuegen. Sie sind die am meisten gebrauchten Drehbaenke in den groessten und bedeutendsten Fabriken in den Vereinigten Staaten von Amerika, wo die "Neues Modell Drehbaenke" in Gruppen von 2 bis 50 Drehbaenke in manchen Verkstaetten in Gebrauch sind. Einige unserer bedeutendsten Kunden sind auf dem Rueckumschlage abgebildet.

Geschichte: Die South Bend Lathe Works waren im Jahre 1906 in South Bend, Indiana Vereinigte Staaten von Amerika errichtet, und haben fuer 24 Jahre unter derselben Verwaltung ununterbrochen gearbeitet, und die ganze Zeit der Anfertigung von "South Bend Leitspindel Drehbaenken mit Raeder Vorgelegen" gewidmet.

Faehigkeit: Die Faehigkeit unserer Anlagen fuer die Anfertigung von "South Bend Drehbaenken" ist 5000 Maschinen im Jahre. Die ganze Anlage ist mehr als vier Acker gross. In Gebaeuden ist ueber 180,000 Quadrat Fuesse Arbeitsraum, welcher ausschliesslich zur Herstellung dieser modernen Drehbaenke benutzt wird.

Descrição do Torno South Bend de novo modelo e da fabrica onde é feito

O Torno para 1930 de Novo Modelo de Engrenagem de Dobrar South Bend para abrir roscas, cuja descrição e ilustrações constam deste catalogo, é destinado para trabalho á machina de metaes em modernas instalações fabris e industriais. Recomendamos este Torno Mechanico Novo Modelo para o quarto de ferramentas para fazer ferramentas, calibres de roscas, matrizes de precisão, etc., em que se exija a maior precisão, assim como para instalações fabris para produção de trabalhos, pois representa um torno incomparavel para toda a obra em que se exijam exactidão, velocidade e economia.

Os Tornos Mechanicos Novo Modelo são feitos em nove tamanhos basicos e em sete feitos diferentes. Sejam quaes forem os seus tamanhos e tipos podem ser munidos de ferramentas e accesorios para produção fabril e trabalho de quarto de ferramentas, de modo a satisfazerem todas as exigencias de uma instalação moderna. São tornos que tem grande aceitação nas fabricas mais importantes e acreditadas dos Estados Unidos, onde são empregados em grupos de dois a cinquenta tornos em algumas officinas. A capa trazeira apresenta alguns dos seus maiores possuidores.

Historia. A South Bend Lathe Works foi fundada no anno de 1906 em South Bend, Indiana, E. U. A., e ha vinte e quatro annos que faz negocios continuamente sob á mesma administração, devotando todo o seu tempo á manufactura de Tornos South Bend com engrenagem de dobrar.

Capacidade. A produção de nossa fabrica de Tornos South Bend é de cinco mil tornos por anno. A fabrica inteira cobre uma superficie de mais de 1,6 hectares. Em nossos edificios ha uma superficie total de 16.750 metros quadrados usada inteiramente na fabricação destes tornos modernos.

Résumé sur le Tour Nouveau Modèle South Bend, et l'usine où il est construit.

Le Tour á Fileter avec contre arbre á harnais, nouveau modèle, de l'année 1930, illustré et décrit dans ce catalogue est conçu pour le travail des métaux dans les usines et manufactures modernes. Quand l'exactitude la plus grande est requise, comme pour outils, cabarits, outils á tarauder modèles, etc., nous recommandons le Tour nouveau modèle, aussi bien que pour la production en masse parce que ce Tour est idéal quand vitesse, justesse et économie sont essentielles.

Le Tour Nouveau Modèle est régulièrement construit en neuf différentes grandeurs, et sept plans différents. Tous ces modèles peuvent être équipés avec outils et attachements pour la production en masse, ainsi que pour travaux de précision et donnent parfaite satisfaction. Ils sont très populaires dans les plus grandes et plus prospères usines des Etats Unis d'Amérique, où les différents modèles sont employés en groupes de 2 á 50. Quelques uns de nos principaux clients sont nommés sur le dos de la couverture

Historie—Les établissements "South Bend Lathe Works," furent établis á South Bend, Indiana, Etats-Unis d'Amérique, en 1906 et ont été en opération durant 24 ans sous le même ménageement, dévouant tout ce temps á la construction des Tours á fileter á contre arbre á harnais débrayable.

Rendement—Le rendement de nos usines á South Bend est de cinq mille Tours par an. La superficie des usines couvre plus de quatre acres. Les bâtiments ont une surface de planché de 180,000 pouces carrés, employés uniquement á la construction de ces Tours modernes.

**THE NAME OF EACH PART OF A LATHE AND
THE NUMBER IT IS KNOWN BY**

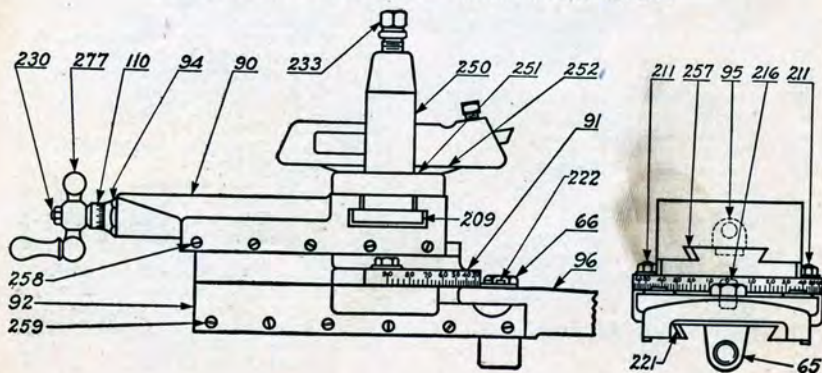
The number and the name of the principal parts of the lathe are tabulated on this and the following page. To find the name of the part of the lathe, locate on the drawing the part you wish and its number, then locate on the tabulation this number and the name of the lathe part.

These parts that are numbered and indicated apply to all sizes and types of South Bend Lathes.

No.	Name	No.	Name
1	Bed.	61	Saddle Gib.
3	Long Legs.	62	Saddle Lock.
4	Lead Screw Bracket, Front.	63	Cross Feed Bushing.
5	Lead Screw Bracket, Rear.	64	Cross Feed Gra. Collar.
10	Head Stock.	65	Cross Feed Nut.
11	Head Stock Cap, Large.	66	Cross Feed Nut Shoulder Screw.
11A	Head Stock Cap Shims, Large.	67	Thread Cutting Stop.
12	Head Stock Cap, Small.	70	Apron.
12A	Head Stock Cap Shims, Small.	71	Apron Hand Wheel.
13	Head Stock Clamp Plate, Rear.	72	Lead Screw Half Nut.
14	Spindle Cone.	73	Lead Screw Half Nut Gib (2).
15	Bull Gear.	74	Nut Cam.
16	Bull Gear Clamp.	75	Nut Cam Washer.
17	Cone Pinion.	76	Rack Pinion Gear.
18	Quill Gear.	77	Apron Worm Wheel.
19	Quill Sleeve.	78	Apron Clutch Sleeve Bushing.
20	Quill Sleeve Pinion.	79	Apron Worm Bracket.
21	Ecc. Shaft Bushing, Rear.	80	Apron Clutch Sleeve.
21F	Ecc. Shaft Bushing, Front.	81	Apron Clutch.
22	Bronze Box, Large.	82	Apron Clutch Knob.
23	Bronze Box, Small.	83	Apron C. F. Lever.
24	Back Gear Lever.	84	Apron C. F. Lever Knob.
25	Spindle Take-up Nut.	85	Apron C. F. Gear.
25A	Spindle Take-up Nut Screw.	86	Apron Idler Gear.
27	Reverse Twin Gears (2).	87	Apron C. F. Pinion.
28	Reverse Gear.	88	Cross Feed Stud Washer.
29	Stud Gear.	89	Hand Wheel Pinion Washer.
30	Spindle Reverse Gear.	90	Compound Rest Top.
31	Change Gear Bracket.	91	Compound Rest Swivel.
32	Change Gear.	92	Compound Rest Base.
33	Change Gear Idler.	93	Worm Support Bracket.
34	Bushing for Change Gear Idler.	94	Compound Rest Bushing.
35	Change Gear Collar on L. S.	95	Compound Rest Nut.
36	Compound Idler Gear, Large.	96	Compound Rest Chip Guard.
37	Compound Idler Gear, Small.	97	Apron Feed Lock.
38	Bushing for Comp. Idler Gear.	100	C. S. Friction Pulleys (2).
39	Thrust Collar on Lead Screw.	101	C. S. Friction Spiders (2).
40	Large Face Plate.	102	C. S. Friction Fingers (2).
41	Small Face Plate.	103	C. S. Cone.
42	Turning Gear.	103W	C. S. Cone Counterweight.
43	Change Gear Wrench.	104	C. S. Collars (4).
50	Tail Stock Top.	105	C. S. Yoke Lever.
51	Tail Stock Base.	106	C. S. Boxes (2).
52	Tail Stock Nut.	107	C. S. Hangers (2).
53	Tail Stock Hand Wheel.	108	C. S. Shipper Nut.
54	Tail Stock Binding Lever.	109	C. S. Yoke Cone.
55	Tail Stock Wrench.	110	Comp. Rest Graduated Collar.
56	Tail Stock Clamp Plate.	112	Comp. Rest Base Gib Screw.
57	Name Plate.	113	Comp. Rest Top Gib Screw.
58	Saddle Felt Retainer.	125	Steady Rest Base.
59	Saddle Felt.	126	Steady Rest Top.
60	Saddle.	127	Steady Rest Clamp.

No.	Name	No.	Name
146	Change Gear Guard.	245	Thread Cutting Stop Thumb Screw.
147	Change Gear Guard Bracket.	246	Back Gear Lug Set Screw.
148	Quill Gear Guard.	247	Compound Idler Gear Bolt.
149	Bull Gear Guard.	248	T. S. Binding Plug, Upper.
150	Quill Gear Guard, Lower.	249	T. S. Binding Plug, Lower.
151	Quill Pinion Guard.	250	Tool Post.
200	Head Stock Spindle.	251	Tool Post Ring.
201	Tail Stock Spindle.	252	Tool Post Wedge.
202	Back Gear Eccentric Shaft.	253	Tool Post Wrench.
203	Apron Worm.	254	Compound Rest Wrench.
204	Apron Rack Pinion.	255	C. S. Spider Set Screw Wrench.
205	Spindle Sleeve.	257	Compound Rest Top Gib.
206	T. Stock Binding Lever Screw.	258	Comp. Rest Top-Gib Screws.
207	Spindle Thrust Collar.	259	Comp. Rest Base-Gib Screws.
208	Apron Worm Collar.	260	Centers (2).
209	Tool Post Block.	261	C. S. Shaft.
210	Carriage Lock Collar Screw.	262	C. S. Shipper Rod.
211	Compound Rest Swivel Bolts.	263	C. S. Expansion Wedge.
212	C. G. Bracket Collar Screw.	264	C. S. Shipper Nut Washer.
213	Reverse Collar Screw.	271	Machine Handle Ap. H'd. Wheel.
214	Bull Gear Clamp Collar Screw.	272	Machine Handle Apron Cam.
215	Apron Clutch Sleeve Hex. Nut.	273	Machine Handle T. S. Wheel.
216	Compound Rest Swivel Stud.	274	Machine Handle Gear Guard.
217	Steady Rest Lock Bolt.	275	Rack.
218	Auto. Cross Feed Lever Stud.	276	Cross Feed Ball Crank.
219	Reverse Collar Screw Washer.	277	Compound Rest Handle.
220	Apron Clutch Sleeve Pinion.	278	Tail Stock Set-Over Screws (2).
221	Compound Rest Base Gib.	279	Tail Stock Clamp Bolt.
223	Automatic Apron Clutch Screw.	281	Change Gear Guard Pin.
224	Cross Feed Screw.	282	Head Stock Oiler.
225	Apron Hand Wheel Pinion.	283	Tail Stock Clamp Nut.
226	Tail Stock Screw.	284	Reverse Bracket Oiler.
227	Reverse Shaft or Stud.	285	Q. C. G. Box Hub Oiler.
228	Apron Rack Pinion Stud.	286	Tail Stock Oil Hole Screw.
229	Twin Gear Studs (2).	287	Lead Screw Bracket Oiler.
230	Compound Rest Screw.	288	Apron Hand Wheel Oiler.
231	Auto. Cross Feed Stud.	289	Oil Hole Plug.
232	Apron Half Nut Studs (2).	290	Reverse Oil Tube.
233	Tool Post Screw.	291	Q. C. G. Box Hub Oiler Tube.
234	Apron Idler Gear Stud.	292	T. S. Oil Reservoir Plug.
235	Cam Cap Screw.	293	Hexagon Nut-Ap. C. F. Stud.
236	Tail Stock Nut Washer.	294	Hexagon Nut-Ap. R. P. Stud.
237	Reverse Shaft Nut.	295	Hexagon Nut-C. F. Screw.
238	Apron Worm Wheel Washer.	296	Hexagon Nut-C. R. Screw.
239	Apron Worm Key.	300	Lead Screw.
241	Worm Bracket Pin.	600	Gear Box.
242	Hexagon Nut—T. S. Screw.	602	Gear Box Tumbler.
243	C. S. Ball Point Set Screws (2).	617	Top Lever of Gear Box.
244	Fill. H'd. Sc's Apron to Saddle (4).	635	Reverse Bracket.
		650	Primary Gear Guard.

PRINCIPAL PARTS OF COMPOUND REST



AUTO MECHANICS SERVICE BOOK NO. 66
For the Auto Machinist and Apprentice
Price 25c Postpaid



Size 6"x9", 96 Pages,
 120 Illustrations

This practical handbook for the auto mechanic contains 120 halftones, and illustrates and describes the modern methods of machining the important motor parts of the automobile, bus and truck in the Auto Service Station, Garage and Electrical Shop. The best way to do the machine work on each job is carefully explained in detail.

This Service Book is recommended by the large automobile manufacturers for use in their service station shops throughout the world as a reliable guide for the auto mechanic in servicing motors with precision, speed and economy.

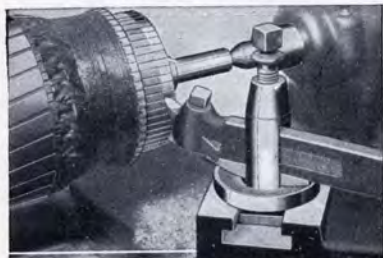
A copy of this valuable reference book will be mailed to any address in the world, postpaid, upon receipt of 25 cents. Coin or stamps of any country accepted.

PARTIAL LIST OF CONTENTS

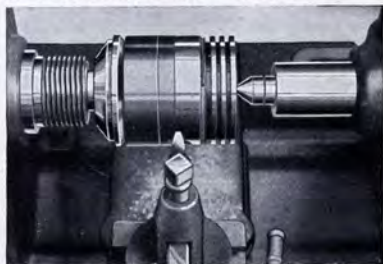
- | | |
|----------------------------------|-------------------------------------|
| Truing armature commutators. | Machining flywheels for ring gears. |
| Testing armatures. | Testing and truing crankshafts. |
| Refacing valves. | Making axles and drive shafts. |
| Testing valves. | Boring connecting rods. |
| Making valve stem guides. | Facing clutch discs. |
| Finishing semi-machined pistons. | Facing hub flanges. |
| Cutting screw threads. | Truing gear flanges. |
| Making shafts. | Undercutting mica. |
| Grinding. | Taper turning and boring. |
| Making bushings. | Chucking work. |
| Truing brake drums. | Milling and keyway cutting. |
| Making mandrels and adapters. | Drilling, boring, reaming. |
| Balancing wheels. | Filing and polishing. |
| Wheel work. | Aircraft and aeronautics. |

And hundreds of other jobs.

TWO PRACTICAL JOBS FROM SERVICE BOOK NO. 66



Taking the Finishing Cut to True the Armature Commutator in the Lathe



Taking the Finishing Cut on a Semi-machined Piston in the Lathe

**PRINCIPAL SPECIFICATIONS, DIMENSIONS, WEIGHTS, ETC., OF
THE VARIOUS SIZES OF SOUTH BEND BACK GEARED
SCREW CUTTING LATHES
(Countershaft Drive Types)**

Swing Over Bed	Length of Bed	Between Centers	Hole Thru Spindle	Swing Over Carriage	Width of Cone	H.P. of Motor	Weight Crated, Lbs.
9-inch Lathes—Quick Change and Standard Change Gear							
9¼ in.	3 ft.	17¼ in.	¾ in.	6¾ in.	1¼ in.	¼	490
9¼ in.	3½ ft.	22¼ in.	¾ in.	6¾ in.	1¼ in.	¼	510
9¼ in.	4 ft.	28¼ in.	¾ in.	6¾ in.	1¼ in.	¼	530
9¼ in.	4½ ft.	35¼ in.	¾ in.	6¾ in.	1¼ in.	¼	550
11-inch Lathes—Quick Change and Standard Change Gear							
11¼ in.	3½ ft.	18 in.	¾ in.	7¾ in.	1½ in.	½	700
11¼ in.	4 ft.	24 in.	¾ in.	7¾ in.	1½ in.	½	725
11¼ in.	5 ft.	36 in.	¾ in.	7¾ in.	1½ in.	½	805
11¼ in.	5½ ft.	42 in.	¾ in.	7¾ in.	1½ in.	½	845
13-inch Lathes—Quick Change and Standard Change Gear							
13¼ in.	4 ft.	16 in.	1 in.	9 in.	1¾ in.	¾	1060
13¼ in.	5 ft.	28 in.	1 in.	9 in.	1¾ in.	¾	1110
13¼ in.	6 ft.	40 in.	1 in.	9 in.	1¾ in.	¾	1160
13¼ in.	7 ft.	52 in.	1 in.	9 in.	1¾ in.	¾	1210
15-inch Lathes—Quick Change and Standard Change Gear							
15¼ in.	6 ft.	36½ in.	1½ in.	10½ in.	2 in.	1	1550
15¼ in.	7 ft.	48½ in.	1½ in.	10½ in.	2 in.	1	1625
15¼ in.	8 ft.	60½ in.	1½ in.	10½ in.	2 in.	1	1735
15¼ in.	10 ft.	84½ in.	1½ in.	10½ in.	2 in.	1	1900
16-inch Lathes—Quick Change and Standard Change Gear							
16¼ in.	6 ft.	34 in.	1¾ in.	11¼ in.	2¼ in.	1	1875
16¼ in.	7 ft.	46 in.	1¾ in.	11¼ in.	2¼ in.	1	1955
16¼ in.	8 ft.	58 in.	1¾ in.	11¼ in.	2¼ in.	1	2035
16¼ in.	10 ft.	82 in.	1¾ in.	11¼ in.	2¼ in.	1	2195
16¼ in.	12 ft.	106 in.	1¾ in.	11¼ in.	2¼ in.	1	2355
18-inch Lathes—Quick Change and Standard Change Gear							
18¼ in.	8 ft.	53½ in.	1⅞ in.	12¾ in.	2½ in.	2	2640
18¼ in.	10 ft.	77½ in.	1⅞ in.	12¾ in.	2½ in.	2	2840
18¼ in.	12 ft.	101½ in.	1⅞ in.	12¾ in.	2½ in.	2	3140
18¼ in.	14 ft.	125½ in.	1⅞ in.	12¾ in.	2½ in.	2	3540
24-inch Lathes—Quick Change and Standard Change Gear							
24¼ in.	8 ft.	43 in.	1¾ in.	17¾ in.	3½ in.	3	4490
24¼ in.	10 ft.	67 in.	1¾ in.	17¾ in.	3½ in.	3	4740
24¼ in.	12 ft.	91 in.	1¾ in.	17¾ in.	3½ in.	3	5140
16-24-inch General Purpose Lathe—Quick Change and Standard Change Gear							
24¼ in.	8 ft.	54 in.	1¾ in.	17 in.	2¼ in.	1	2195
24¼ in.	10 ft.	78 in.	1¾ in.	17 in.	2¼ in.	1	2355
24¼ in.	12 ft.	102 in.	1¾ in.	17 in.	2¼ in.	1	2515
36-inch Brake Drum Lathe—Quick Change and Standard Change Gear							
36¼ in.	6 ft.	27 in.	1¾ in.	17 in.*	2¼ in.	1	2195
36¼ in.	7 ft.	39 in.	1¾ in.	17 in.*	2¼ in.	1	2275
36¼ in.	8 ft.	51 in.	1¾ in.	17 in.*	2¼ in.	1	2355
36¼ in.	10 ft.	75 in.	1¾ in.	17 in.*	2¼ in.	1	2515
42-inch Brake Drum Lathe—Quick Change and Standard Change Gear							
42¼ in.	8 ft.	38 in.	1¾ in.	32 in.*	3½ in.	3	4690
42¼ in.	10 ft.	62 in.	1¾ in.	32 in.*	3½ in.	3	4940
42¼ in.	12 ft.	86 in.	1¾ in.	32 in.*	3½ in.	3	5340

*Maximum swing over tool slide.

GENERAL CATALOG NO. 91-A



Size 6"x9", 104 Pages
300 Illustrations

SPECIAL BULLETINS ON EACH
SIZE LATHE

Special Bulletins of sixteen pages each, 8½x11 inches, are available, printed in attractive colors, for each size New Model South Bend Lathe. These bulletins show large illustrations, and each describes in detail the lathe and its various types, drives, tools and attachments.

If interested in any particular size of lathe, and detailed information is desired, write for special bulletin, specifying size of lathe.

Mailed to any Address in the World, Postpaid, No Charge.

PARTIAL CONTENTS OF EACH BULLETIN

Quick Change Gear Lathes
Standard Change Gear Lathes
Silent Chain Motor Driven Lathes
Tool Room Precision Lathes
Gap Bed Lathes
Junior Bench and Floor Leg Lathes

Taper Attachment
Grinding Attachments
Draw-in Collet Chuck
Milling and Keyway Cutting Attachment
Turrets and Tool Slides
Chucks, Tools and Accessories



Size 8½"x11", 20 Pages
50 Illustrations

Our new General Catalog, No. 91-A, illustrates, describes and prices the entire line of New Model South Bend Back Geared Screw Cutting Precision Lathes, from 9-inch swing to 18-inch swing, Countershaft and Motor Drive. Each size of lathe is fully described with its features and specifications.

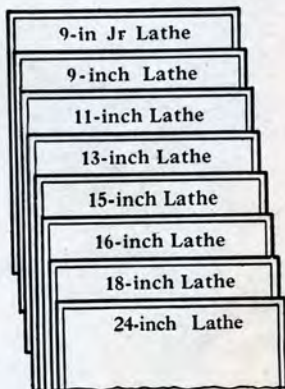
A full line of attachments, chucks, tools and accessories for use on South Bend Lathes is also shown in this catalog, which is a reference book of considerable value to any one interested in mechanical equipment.

Mailed to any Address in the World, Postpaid, No Charge.

PARTIAL LIST OF CONTENTS

Quick Change Gear Lathes
Standard Change Gear Lathes
Tool Room Precision Lathes
Gap Bed Lathes
Brake Drum Lathes
Large Swing Lathes
Taper Attachment
Grinding Attachment

Silent Chain Motor Driven Lathes
Self-Contained Motor Driven Lathes
Horizontal Motor Driven Lathes
Simplex Motor Driven Lathes
Junior Bench and Floor Leg Lathes
Draw-in Collet Chuck Attachment
Milling and Keyway Cutting Attachment
Chucks, Tools and Accessories



Size 8½"x11", 16 Pages

BRAKE DRUM BULLETIN NO. 29

This 20-page Bulletin, 8½x11 inches, shows the New Model South Bend Brake Drum Lathe in two sizes; 36-inch swing and 42-inch swing, in Countershaft Drive and Silent Chain Motor Drive types, complete with features, specifications and prices of each. Self-centering Mandrels and Universal Bearing Adapters for mounting wheels for truing brake drums of buses, trucks and automobiles, are also described in detail.

Mailed to any Address in the World, Postpaid, No Charge.

PARTIAL LIST OF CONTENTS

Brake Drum Lathe in two Sizes
Self-Centering Mandrels
Universal Bearing Adapters
Mandrels and Adapters for Automobiles, Trucks and Buses
Balancing Wheels
Chuck and Tool Assortment

Machining Flywheels
Fitting Ring Gears
Brake Drum Lathe Utility Jobs
Blue Prints of Jobs
Taper Mandrels for Rear Wheels
Brake Drum Machining Time
General Brake Drum Information

MANUAL DEL TORNERO

Escrito en el Idioma Español

El "Manual del Tornero" es un libro de 80 páginas escrito en el idioma español. La edición numero veinte y ocho acaba de salir a luz. Se vende a veinte y cinco centavos el ejemplar.

COMO SE DEVE MANEJAR UM TORNO, NA LINGUA PORTUGUEZA

"Como Se Deve Manejar Um Torno" tem tido vinte e tres edições na lingua portugueza. Há ainda em stock alguns exemplares desta edição, que podem ser adquiridos a dez centavos cada um.

HOW TO RUN A LATHE, IN CHINESE

The cut is from a photograph of the Chinese Version of "How to Run a Lathe," several thousand copies of which were printed in Shanghai. The translation was made by twenty-six engineers representing sixteen different nationalities. We cannot supply copies of this book as there are only a few in this country.



INDEX

Acme Threads	100	Face Plate, Mounting	69
Accuracy of the Screw Cutting Lathe.....	136-139	Face Plate Work.....	70
Alligning Lathe Centers.....	44	Facing Work on Centers.....	49
Angle of Lathe Tools for Cutting.....	28, 29	Fitting a Chuck Plate.....	63, 64
Application of Lathe Tools.....	25-30	Fitting and Testing Screw Threads.....	97
Apron Friction Clutch.....	23	Follower Rest for Lathe.....	59
Arbors, Centers, Drill Pads, etc.....	129	Ford's First Lathe.....	113
Attachments for Lathes.....	104-107	Forged Steel Lathe Tools.....	26
Automatic Cross Feed	23	Friction Feeds of Apron, Automatic.....	23
Automatic Friction Clutch	23	Gap Bed Lathe.....	124
Automatic Longitudinal Feed	23	Gauge Blocks for Precision Measuring.....	107
Automotive Jobs for Lathe.....	130	Gearing Lathe for Cutting Screw Threads.....	99
Auto Mechanics Service Book.....	155	Gear Box, Instructions for Operating.....	93-95
Back Gear Drive of the Spindle.....	22	Gear Cutting Attachment for Lathe.....	107
Back Geared Headstock.....	131	Gears, Information on.....	148
Bearings for Spindle, Handscrapping.....	139	General Purpose Lathe (16-24" Swing).....	125
Belts; Lacing, Shifting, etc.....	16, 17, 146	Grinder for Lathe, Electric.....	114, 115
Bench Lathes	126-128	Grinding and Setting the Threading Tool.....	97
Bench Lathes, Horizontal Motor Drive.....	127	Grinding Tools, Correct Angle for Various Metals	28, 29
Bench Lathes, Simplex Motor Drive.....	128	Grinding Wheels for Various Kinds of Work	115
Bench Lathes, For Manufacturing	112	Grinding Wheels, Truing	115
Bits for Tool Holders.....	27	Half-Nuts in Apron for Thread Cutting.....	23
Blue Prints of Plans, Charts, etc.....	15, 144	Hand Lever Turret for Lathe.....	109, 110
Boring in the Lathe.....	111	Hand Scraping Bearing Surfaces.....	139
Boring Taper Holes.....	80, 83	Headstock, Single Back Geared.....	48
Brake Drum Lathes and Work	132-135	Headstock, Double Back Geared.....	131
Brake Drum Lathes, Bulletin on.....	157	Headstock and Tailstock Alignment Tests.....	137
Brown and Sharpe Tapers	79	Headstock and Tailstock Feature Parts.....	140
Brown and Sharpe Worm Thread.....	102	Height of Cutting Edge of Thread Tool.....	28, 29
Byrd South Polar Expedition.....	150	Height of Cutting Tool for Steel, Cast Iron.....	30
Callipers and Their Use.....	31-35	Height of Cutting Tool for Taper Work.....	75
Catalog on Lathes, Attachments, etc.....	157	Horizontal Motor Drive for Bench Lathes.....	127
Centers, Drill Pads and Arbors.....	129	Indexing and Speed Reducing Attachment.....	116
Centers, Facing a Job on.....	49	Index Plates for Lathes.....	92, 93
Centers, How to Align.....	44	Inventors and Mechanics.....	5
Centers, Mounting Work on.....	43	Jig Boring Attachment for Lathe.....	107
Centers, Removing from Headstock.....	42	Keyways, American Standard Sizes.....	106
Centers, Testing Alignment of.....	50	Knurling in the Lathe.....	52
Centers, Truing	81	Lathe Automatic Cross Feed	23
Center Rest for Lathe.....	58	Lathe Automatic Friction Clutch	23
Centering Work, Methods of.....	35-37	Lathe Automatic Longitudinal Feed	23
Chuck and Tool Assortments for Lathes.....	117	Lathe, Back Gear Drive	22
Chucks for Lathes.....	61-68	Lathe, Headstock Spindle Speeds.....	48
Chuck Plate, Threading and Fitting.....	63, 64	Lathe Bed, Prismatic "V" Ways.....	141
Chucking Work	66, 68	Lathe, Bench Types: Countershaft and Motor Drive	126-128
Cleaning Threaded Hole of Chuck.....	71	Lathes, Brake Drum	132-135
Collets: Round, Square, Hexagonal.....	120, 121	Lathe, Brake Drum, Bulletin on.....	157
Compound Gearing for Thread Cutting.....	92	Lathe, Bulletins on Each Size.....	157
Compound Rest of Lathe, Graduated.....	80	Lathe Centers, Mounting Work on.....	43
Countersinking Center Holes	38, 40	Lathe Chucks and Chucking Work.....	61-68
Countersinking Work, Examples of.....	38-40	Lathe, Compound Geared for Thread Cutting.....	92
Countershaft and Equipment	21	Lathe, Design and Features.....	8
Countershaft, Hanging and Setting Up.....	13	Lathe, Direct Cone Drive.....	22
Countershaft, Oiling	19	Lathe Dogs, Common, Safety, Clamp Types.....	41
Countershaft, Speed of	13	Lathe Equipment and Countershaft.....	21
Crankshaft, Machining in Lathe.....	57	Lathe Equipped with Turret.....	108-110
Cross Feed of Lathe, Automatic.....	23	Lathe Equipped for Manufacturing	108, 112
Cutter Bits for Lathe.....	27	Lathe Features Described	9
Cutting Speeds for Different Metals.....	47	Lathe, Gap Bed	124
Cutting Speeds of Revolving Work.....	47	Lathe, General Purpose (16-24" Swing).....	125
Decimal Equivalents	147	Lathe, History of	3, 4
Depth of Roughing Chip for Each Size Lathe.....	46	Lathe, Horizontal Motor Drive.....	127
Dial Test Indicator.....	136	Lathe Information in French, German, Spanish, Portuguese.....	151
Direct Cone Drive of the Spindle.....	22	Lathe, Leveling	12
Don'ts for Machinists.....	145	Lathe, Locating and Setting.....	12-15
Draw-in Collet Chuck Attachment.....	120, 121	Lathe, Maudslay	4
Drill Grinding Gauge	73	Lathe, Motor Drive, Floor Leg.....	119, 122, 123
Drill Pads, Arbors, Centers, etc.....	129	Lathe, Names and Numbers.....	152-154
Drilling, Reaming and Tapping.....	73, 74		
Emery Wheel Speeds.....	115		
Equipment and Countershaft for Lathes.....	21		
Equipment for Small Machine Shop.....	10, 11		
Erection and Foundation Plans.....	15, 144		
Expanding Mandrel	53		

INDEX

- Lathe, Notes on 149
 Lathe, Oiling 18, 19
 Lathe, Design and Features 8, 9
 Lathe, Principal Parts 6
 Lathe, Specifications, Dimensions and Weights
 of Popular Sizes 156
 Lathe, Quick Change Gear 118-125
 Lathe, Safety Device 24
 Lathe, Serial Number of 141
 Lathe, Shop Installations 20
 Lathe, Simple Geared for Thread Cutting 91
 Lathe, Simplex Motor Drive 128
 Lathe, Size of, How to Determine 7
 Lathe, Starting and Operating 22, 23
 Lathe Tools 25-27
 Lathe Tools, Grinding and Sharpening 28, 29
 Lathes, Tree 3
 Lathes, Standard Change Gear 91, 92, 126
 Lathes, Used by Byrd South Polar Expedi-
 tion 150
 Left Hand Thread 99
 Longitudinal Feed, Automatic 23

 Machine Shop Course for Apprentices 142, 143
 Machining in the Chuck 65-68
 Machining on the Face Plate 69-71
 Machining, Between Centers 45-60
 Mandrels and Adapters for Brake Drums 133, 134
 Mandrels, Machining Work on 53, 54
 Manufacturing and Production Work 55, 108
 Measuring Screw Threads 89
 Measuring with Callipers 31, 32
 Mechanics and Inventors 5
 Metals, Cutting Speeds for 47
 Metric and English Linear Measures 147
 Metric Threads 104
 Metric Transposing Gear Attachment 104
 Micrometer Callipers 34
 Micrometer Carriage Stop 84
 Milling Arbors 106
 Milling Cutters for Keyways 106
 Milling Attachments for Lathe 105
 Morse Tapers 76
 Motor Drive, Individual 11
 Motor Drive Lathes, Bench 127, 128
 Motor Drive Lathes, Floor Leg 122, 123
 Mounting Lathe Centers in Spindle 42, 43
 Mounting Work in Center Rest 58
 Multiple Threads 103
 Notes on the Back Geared Screw Cutting
 Lathe 149
 Oiling the Countershaft 19
 Oiling the Lathe 18
 Ordering Repair Parts for Lathe 152-154
 Pipe Centers for Lathes 129
 Pitch and Lead of Screw Thread 103
 Plans for Location and Erection of Lathe 144
 Projects for Machine Shop Course 143
 Pulleys, Rules for Size and Speed of 14
 Punching Center Point on Work 36

 Quick Change Gear Box for Threading and
 Turning Feeds 94
 Quick Change Gear Box, Operation of 93
 Quick Change Gear Lathes 118-125

 Reaming, Tapping and Drilling 73, 74
 Relieving or Backing Off Attachment 116
 Removing Broken Drill From Work 38
 Removing Tight Fitting Chuck or Face Plate
 Reverse Lever of Headstock 71
 Rough and Finish Turning Steel and Cast
 Iron 45
 Roughing Chip, Depth of 46
 Rules for Calculating Amount of Tailstock
 Set-Over for Turning Tapers 78
 Rules for Gearing Lathes for Thread Cutting
 Safety Device for Threads and Feeds 24
 Screw Threads, Cutting Various Types 95-104
 Screw Thread Pitches and Formulas 86-104
 Screw Threads, Terms Relating to 87
 Screw Thread Testing and Fitting 97
 Semi-Machined Chuck Back 63, 64
 Setting Over Tailstock for Taper Turning 77, 78
 Setting Thread Tool for Cutting Threads 90
 Shifting Belts 17, 146
 Silent Chain Motor Drive Lathes 119, 122
 Simplex Motor Drive for Bench Lathes 128
 Size of Lathe, How to Determine 7
 Size of Chuck for a Lathe 62
 Speed and Size of Pulleys 14
 Speed of Countershafts 13
 Speed Indicator for Revolving Work 47
 Speed Reducing and Indexing Attachment 116
 Spindle Speeds of Lathes 48
 Spindle, Direct Cone Drive 22
 Spindle, Back Gear Drive 22
 Split Nut Lever for Thread Cutting 23
 Square Screw Thread 101
 Standard Change Gear Lathes 91, 92, 126
 Standard Keyways for Pulleys and Shafts 106
 Step Chuck and Closer 121
 Stop for Thread Cutting 95

Tables of Information:
 Belts, Information on 16, 146
 Circle and Sphere Rules 146
 Cutting Speeds for Metals 47
 Decimal Equivalents 147
 Don'ts for Machinists 145
 How to Mount Work in a Lathe Chuck 66
 Information on Gears 148
 Pulleys, Rules for Speed and Size 14
 Screw Thread Terms 87
 Tap Drill Sizes 88
 Tapers, Brown and Sharpe 79
 Tapers, Morse 76
 Wire Gauge Standards 150
 Tailstock and Headstock Parts 140
 Tap Drill Sizes 88
 Tapping, Reaming and Drilling 73, 74
 Taper Attachment for Lathe 82, 83
 Tapers, Standard Dimensions of 76, 79
 Taper Turning and Boring 75
 Tapers, Turning with Tailstock Set Over 77, 78
 Taper Work, Cutting Threads on 102
 Test Card Showing Factory Tests on Lathe 138
 Test Dial Indicator 72, 136
 Testing Alignment of Centers 50, 137
 Testing Taper Fit 78
 Testing Instruments for Chuck Work, etc. 72
 Testing or Truing Lathe Centers 81
 Thread Cutting, Rules for Gearing Lathes 99
 Thread Cutting Stop 96
 Thread Dial Indicator for Lathes 98
 Threads, Terms Relating to 87
 Tool Bits (High Speed) for Tool Holders 27
 Tools and Chucks, Assortments of 117
 Tools, Correct Angle for Various Metals 28, 29
 Tools for Lathe 25-29
 Tools, Height of Cutting Edge 30, 75, 89, 90
 Tools, Grinding or Sharpening 28, 29
 Tool Post Turret 110
 Tool Room Lathes 118, 119
 Tool Gauge for Screw Threads 89
 Transposing Gears for Metric Threads 104
 Turning Steel and Cast Iron 45
 Turning Taper with Taper Attachment 82-84
 Turning Taper by Set-over Tailstock 77, 78
 Turrets and Turret Work 108-110
 "V" Ways of Lathe Bed 141
 Whitworth Standard Screw Thread 103
 Woodruff Keyway 106
 Wood Turning on Lathes 85

How to Become a Machinist

- 1. Keep your cutting tools sharp.**
- 2. Look at your drawing carefully before starting your job.**
- 3. Be sure your machine is set up right before starting the work.**
- 4. Take your measurements accurately.**
- 5. Keep your machine well oiled, clean and neat. Personal neatness will give you personality.**
- 6. Take an interest in your job; don't feel that you are forced to work.**
- 7. Learn the fundamentals of mechanical drawing.**
- 8. Keep your belts tight and free from oil.**
- 9. Take as heavy a cut as the machine and cutting tool will stand until you are near the finished size; then finish carefully and accurately.**
- 10. Try to understand the mechanism of the machine you are operating.**
- 11. Hold yourself responsible for the job you are working on.**
- 12. Keep your eyes on the man ahead of you: you may be called on to take his place some day.**
- 13. Have a place for everything, and keep everything in its place.**
- 14. Read one or two of the technical magazines relating to your line of work.**
- 15. If a boy learns a trade properly he becomes a first-class mechanic, but if he has ability he need not stop at that. Henry Ford, George Westinghouse and others got their start because they were mechanics.**
- 16. If you have spoiled a job, admit your carelessness to your foreman, and don't offer any excuses.**

SOUTH BEND LATHE WORKS

NOTE: A Blue Print (12"x18") of the above sixteen suggestions, suitable for wall display, will be mailed upon the receipt of 10c to cover cost of mailing.

SOUTH BEND LATHE WORKS

435 E. Madison Street

SOUTH BEND, INDIANA, U. S. A.